

METAL OXIDE VARISTOR

# ZENAMIC

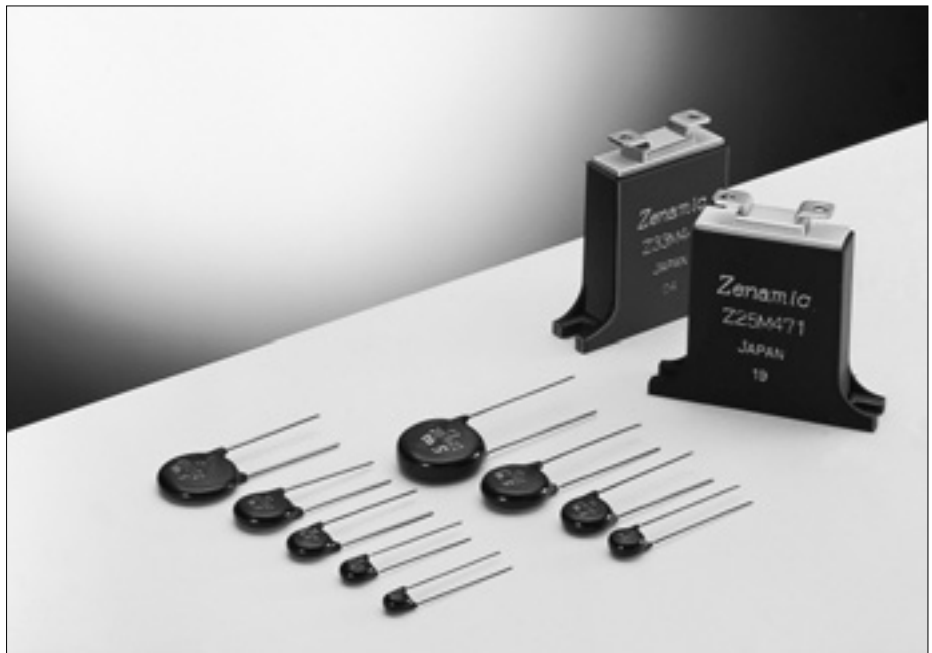

ZENAMIC is the product name of a metal oxide varistor. ZENAMIC Transient/Surge Absorber, Series D is newly released through our continued research in ceramic material composition of ZnO varistor and manufacturing process, featuring large surge current handling capability and energy handling capability for absorbing transient overvoltage in compact size.

## Features

- Improved in "Surge Current Handling Capability (at 8/20 $\mu$ s, 2 times)" by about 2 times over the current.
- Very large "Energy Handling Capability" absorbing transient overvoltages in compact sizes.
- Lower Clamping Voltage for better surge protection.
- Fast response to high speed transient/surge voltage.
- Wide products range for transient/surge protection on AC 100V to AC 480V nominal system with the maximum peak current ratings of 600A to 7000A (at 8/20  $\mu$ s, 2 times).

### V-I characteristics

ZENAMIC has the forward-reverse symmetrical electrical characteristics as shown in the figure 1. The voltage-current curves show the varistor characteristics in the range 1 μA to 10<sup>4</sup>A, and show the resistance characteristics for the range under 1 μA and over 10<sup>4</sup>A in the figure 2. The voltage across terminals when test current (It: 1 mA) is applied to ZENAMIC is the standard varistor voltage (Vz), and the voltage across terminals when a standard surge (Ip) is applied represents the maximum suppression voltage (Vc).

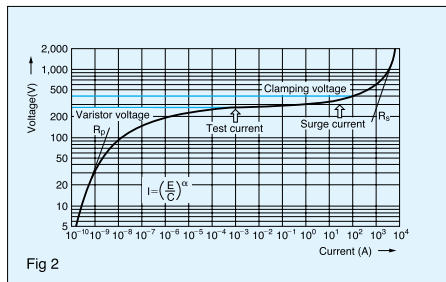
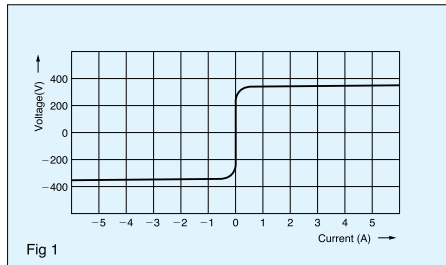

### Temperature characteristics

In the small current range, ZENAMIC features outstanding temperature characteristics. A shunt resistance Rp of metal oxide varistor has the temperature characteristics which is determined by the following equation.

$$R_p = A e^{E_g / 2kT} \quad (2)$$

T: Absolute temperature  
k: Boltzmann constant  
A, Eg: constants

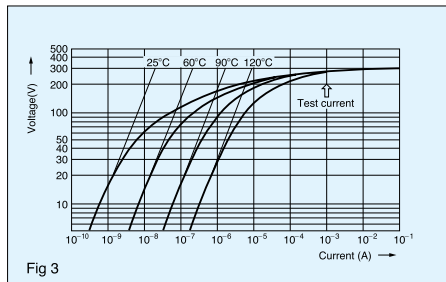

As shown in the figure 3, the temperature dependence characteristics are shown clearly in the low current area.

### Surge waveform

A surge waveform varies according to the sources. An EXP waveform is used for surge testing of ZENAMIC, while a AC half-wave is used for the energy absorption test. The EXP waveform reaches its peak voltage (current) at [ta] as shown in the figure 5, and then decreases as time passes and reaches half of the peak voltage (current) at [tb]. This type of the EXP waveform is shown as a [ta/tb] voltage (current) waveform. For surge testing of ZENAMIC, the 8/20 μ sec current waveform is used.

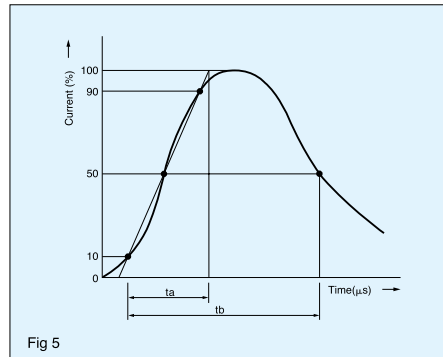

### Part Number.

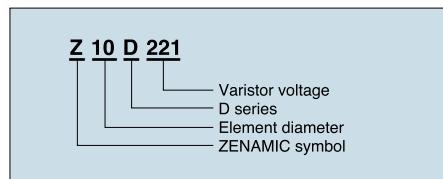

### Application notes (General)

1. A surge excess of the specified Maximum Peak Current may cause short circuit or mechanical damage. The following measures are recommended.

- In case that ZENAMIC is used in line to ground, the ground fault circuit interrupter shall be applied in location A or thermally coupled fuse shall be applied in location C.
- ZENAMIC shall not be used near heat generating device and free from direct sunlight.
- ZENAMIC shall not be used near the flammable materials.

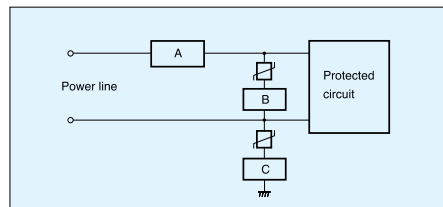

- 1) Location of the over current protector (circuit breaker or current fuse) shall be in the power line to the circuit (Location A) or in series with ZENAMIC (Location B).
- 2) It is recommended that a fuse listed in the table be put in location A or B.
- 3) In case that ZENAMIC is used in line to ground, the ground fault circuit interrupter should be applied in location A or thermally coupled fuse should be applied in location C.

Part Number	Z5D□□□	Z7D□□□	Z10D□□□
Rating of fuse	3A max.	5A max.	7A max.

Part Number	Z15D□□□	Z21D□□□
Rating of fuse	10A max.	15A max.

Refer to the related Safety Standards.

### Applications

Power lines and surge absorption units with error display (SA series).

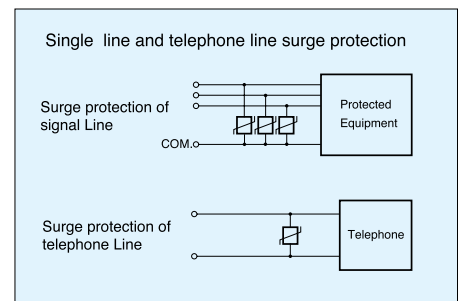
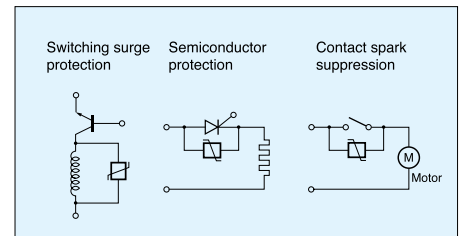
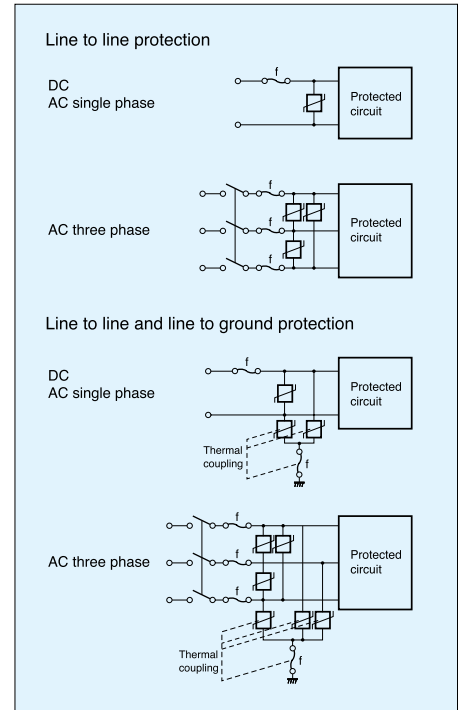

## Z7D Series

### Specifications

Part No.	Varistor Voltage	Maximum Allowable Voltage		Clamping Voltage (max.)	Rated Power	Maximum Energy		Maximum Peak Current (8/20μs) 2 times	Capacitance (TYP) 1kHz
		V <sub>1mA</sub> (V)	AC <sub>rms</sub> (V)			DC(V)	V(V)		
Z7D180	18(16-20)	11	14	36 at 2.5A	0.02	1.1	0.9	250	3800
Z7D220	22(20-24)	14	18	43	0.02	1.3	1.1	250	3600
Z7D270	27(24-30)	17	22	53	0.02	1.6	1.3	250	3400
Z7D330	33(30-36)	20	26	65	0.02	2.0	1.6	250	2900
Z7D390	39(35-43)	25	31	77	0.02	2.4	1.9	250	1600
Z7D470	47(42-52)	30	38	93	0.02	2.8	2.3	250	1550
Z7D560	56(50-62)	35	45	110	0.02	3.4	2.7	250	1500
Z7D680	68(61-75)	40	56	135	0.02	4.1	3.3	250	1200
*1 Z7D820	82(74-90)	50	65	135 at 10A	0.25	7	5	1250	810
*1 Z7D101	100(90-110)	60	85	165	0.25	8.5	6	1250	700
*1 Z7D121	120(108-132)	75	100	200	0.25	10	7	1250	590
*1 Z7D151	150(135-165)	95	125	250	0.25	13	9	1250	500
*1 Z7D201	200(185-225)	130	170	340	0.25	17.5	12.5	1250	200
*1 Z7D221	220(198-242)	140	180	360	0.25	19	13.5	1250	190
*1 Z7D241	240(216-264)	150	200	395	0.25	21	15	1250	170
*1 Z7D271	270(247-303)	175	225	455	0.25	24	17	1250	150
*1 Z7D331	330(297-363)	210	270	545	0.25	28	20	1250	130
*1 Z7D361	360(324-396)	230	300	595	0.25	32	23	1250	130
*1 Z7D391	390(351-429)	250	320	650	0.25	35	25	1250	130
*1 Z7D431	430(387-473)	275	350	710	0.25	40	27.5	1250	120
*1 Z7D471	470(423-517)	300	385	775	0.25	42	30	1250	100 *2
*1 Z7D511	510(459-561)	320	410	845	0.25	45	32	1250	90 *2

1. Operating temperature range: -40 to 85°C

2. Storage temperature range: -40 to 125°C

\*1 UL 1449 approved model

\*2 Measured at 1MHz

## Z10D Series

### Specifications

Part No.	Varistor Voltage	Maximum Allowable Voltage		Clamping Voltage (max.)	Rated Power	Maximum Energy		Maximum Peak Current (8/20μs) 2 times	Capacitance (TYP) 1kHz
		V <sub>1mA</sub> (V)	AC <sub>rms</sub> (V)			DC(V)	V(V)		
Z10D180	18(16-20)	11	14	36 at 5A	0.05	2.6	2.2	500	16000
Z10D220	22(20-24)	14	18	43	0.05	3.2	2.6	500	11000
Z10D270	27(24-30)	17	22	53	0.05	3.9	3.2	500	8000
Z10D330	33(30-36)	20	26	65	0.05	4.8	4.0	500	6300
Z10D390	39(35-43)	25	31	77	0.05	5.6	4.7	500	5200
Z10D470	47(42-52)	30	38	93	0.05	6.8	5.6	500	4600
Z10D560	56(50-62)	35	45	110	0.05	8.1	6.7	500	3750
Z10D680	68(61-75)	40	56	135	0.05	9.8	8.2	500	2800
* Z10D820	82(74-90)	50	65	135 at 25A	0.4	14	10	2500	2000
* Z10D101	100(90-110)	60	85	165	0.4	17	12	2500	1700
* Z10D121	120(108-132)	75	100	200	0.4	20	14.5	2500	1400
* Z10D151	150(135-165)	95	125	250	0.4	25	18	2500	1100
* Z10D201	200(185-225)	130	170	340	0.4	35	25	2500	430
* Z10D221	220(198-242)	140	180	360	0.4	39	27.5	2500	410
* Z10D241	240(216-264)	150	200	395	0.4	42	30	2500	380
* Z10D271	270(247-303)	175	225	455	0.4	49	35	2500	350
* Z10D331	330(297-363)	210	270	545	0.4	58	42	2500	300
* Z10D361	360(324-396)	230	300	595	0.4	65	45	2500	300
* Z10D391	390(351-429)	250	320	650	0.4	70	50	2500	300
* Z10D431	430(387-473)	275	350	710	0.4	80	55	2500	270
* Z10D471	470(423-517)	300	385	775	0.4	85	60	2500	230
* Z10D511	510(459-561)	320	410	845	0.4	92	67	2500	210
* Z10D561	560(504-616)	350	450	930	0.4	92	67	2500	200
* Z10D681	680(612-748)	420	560	1120	0.4	92	67	2500	170
* Z10D751	750(675-825)	460	615	1240	0.4	100	70	2500	160
* Z10D821	820(738-902)	510	670	1355	0.4	110	80	2500	140
* Z10D911	910(819-1001)	550	745	1500	0.4	130	90	2500	120
* Z10D102	1000(900-1100)	625	825	1650	0.4	140	100	2500	110

1. Operating temperature range: -40 to 85°C

2. Storage temperature range: -40 to 125°C

\* UL 1449 approved model

## Z15D Series

### Specifications

Part No.	Varistor Voltage	Maximum Allowable Voltage		Clamping Voltage (max.)	Rated Power	Maximum Energy		Maximum Peak Current (8/20 $\mu$ s) 2 times	Capacitance (TYP) 1kHz
		V <sub>1mA</sub> (V)	AC <sub>rms</sub> (V)			DC(V)	V(V)		
Z15D180	18(16-20)	11	14	36 at 10A	0.1	5.2	4.3	1000	25000
Z15D220	22(20-24)	14	18	43	0.1	6.3	5.3	1000	20000
Z15D270	27(24-30)	17	22	53	0.1	7.8	6.5	1000	16000
Z15D330	33(30-36)	20	26	65	0.1	9.5	7.9	1000	12200
Z15D390	39(35-43)	25	31	77	0.1	11	9.4	1000	7000
Z15D470	47(42-52)	30	38	93	0.1	14	11	1000	6750
Z15D560	56(50-62)	35	45	110	0.1	16	13	1000	6500
Z15D680	68(61-75)	40	56	135	0.1	20	16	1000	5500
* Z15D820	82(74-90)	50	65	135 at 50A	0.6	28	20	4500	3700
* Z15D101	100(90-110)	60	85	165	0.6	35	25	4500	3200
* Z15D121	120(108-132)	75	100	200	0.6	42	30	4500	2700
* Z15D151	150(135-165)	95	125	250	0.6	53	37.5	4500	2200
* Z15D201	200(185-225)	130	170	340	0.6	70	50	4500	770
* Z15D221	220(198-242)	140	180	360	0.6	78	55	4500	740
* Z15D241	240(216-264)	150	200	395	0.6	84	60	4500	700
* Z15D271	270(247-303)	175	225	455	0.6	99	70	4500	640
* Z15D331	330(297-363)	210	270	545	0.6	115	80	4500	580
* Z15D361	360(324-396)	230	300	595	0.6	130	90	4500	540
* Z15D391	390(351-429)	250	320	650	0.6	140	100	4500	500
* Z15D431	430(387-473)	275	350	710	0.6	155	110	4500	450
* Z15D471	470(423-517)	300	385	775	0.6	175	125	4500	400
* Z15D511	510(459-561)	320	410	845	0.6	190	136	4500	350
* Z15D561	560(504-616)	350	450	930	0.6	190	136	4500	340
* Z15D681	680(612-748)	420	560	1120	0.6	190	136	4500	320
* Z15D751	750(675-825)	460	615	1240	0.6	210	150	4500	310
* Z15D821	820(738-902)	510	670	1355	0.6	235	165	4500	280
* Z15D911	910(819-1001)	550	745	1500	0.6	255	180	4500	250
* Z15D102	1000(900-1100)	625	825	1650	0.6	280	200	4500	230

1. Operating temperature range: -40 to 85°C \* UL 1449 approved model  
 2. Storage temperature range: -40 to 125°C

## Z21D Series

### Specifications

Part No.	Varistor Voltage	Maximum Allowable Voltage		Clamping Voltage (max.)	Rated Power	Maximum Energy		Maximum Peak Current (8/20 $\mu$ s) 2 times	Capacitance (TYP) 1kHz
		V <sub>1mA</sub> (V)	AC <sub>rms</sub> (V)			DC(V)	V(V)		
Z21D180	18(16-20)	11	14	36 at 20A	0.2	13	12	2000	40000
Z21D220	22(20-24)	14	18	43	0.2	16	14	2000	30000
Z21D270	27(24-30)	17	22	53	0.2	19	17	2000	24500
Z21D330	33(30-36)	20	26	65	0.2	24	21	2000	20000
Z21D390	39(35-43)	25	31	77	0.2	28	25	2000	13800
Z21D470	47(42-52)	30	38	93	0.2	34	30	2000	13500
Z21D560	56(50-62)	35	45	110	0.2	41	36	2000	12200
Z21D680	68(61-75)	40	56	135	0.2	49	44	2000	11500
* Z21D820	82(74-90)	50	65	135 at 100A	1.0	56	40	6500	7500
* Z21D101	100(90-110)	60	85	165	1.0	70	50	6500	6500
* Z21D121	120(108-132)	75	100	200	1.0	85	60	6500	5500
* Z21D151	150(135-165)	95	125	250	1.0	106	75	6500	4500
* Z21D201	200(185-225)	130	170	340	1.0	140	100	6500	1700
* Z21D221	220(198-242)	140	180	360	1.0	155	110	6500	1600
* Z21D241	240(216-264)	150	200	395	1.0	168	120	6500	1500
* Z21D271	270(247-303)	175	225	455	1.0	190	135	6500	1300
* Z21D331	330(297-363)	210	270	545	1.0	228	160	6500	1100
* Z21D361	360(324-396)	230	300	595	1.0	255	180	6500	1100
* Z21D391	390(351-429)	250	320	650	1.0	275	195	6500	1100
* Z21D431	430(387-473)	275	350	710	1.0	303	215	6500	1000
* Z21D471	470(423-517)	300	385	775	1.0	350	250	6500	900
* Z21D511	510(459-561)	320	410	845	1.0	382	273	6500	800
* Z21D561	560(504-616)	350	450	930	1.0	382	273	6500	750
* Z21D681	680(612-748)	420	560	1120	1.0	382	273	6500	650
* Z21D751	750(675-825)	460	615	1240	1.0	420	300	6500	600
* Z21D821	820(738-902)	510	670	1355	1.0	460	325	6500	530
* Z21D911	910(819-1001)	550	745	1500	1.0	510	360	6500	500
* Z21D102	1000(900-1100)	625	825	1650	1.0	565	400	6500	450

1. Operating temperature range: -40 to 85°C \* UL 1449 approved model  
 2. Storage temperature range: -40 to 125°C

Dimensions

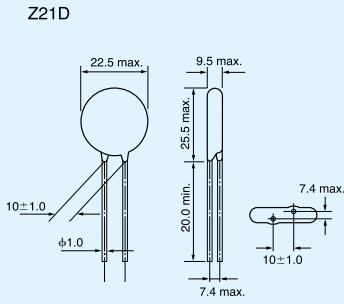
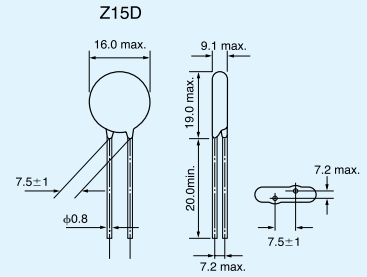
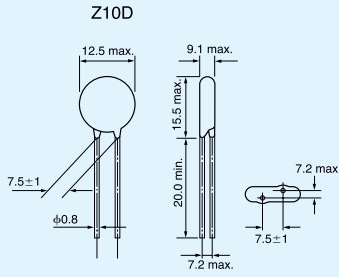
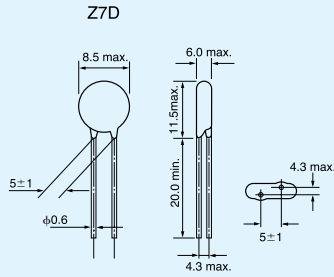

Crimped Leads and Taped  
Z7D□□□ T4C

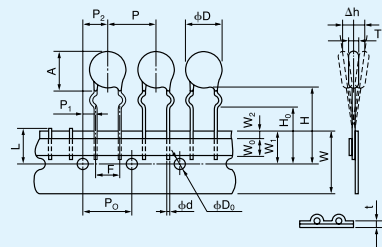

\*Dimension "T": Conforms to each individual specification  
\*Packing quantity: 1000pcs/BOX

Symbol	Type I	Symbol	Type I
P	12.7±1.0	W <sub>0</sub>	5.0min
P <sub>0</sub>	12.7±0.3	W <sub>1</sub>	9.0±0.5
P <sub>1</sub>	3.85±0.70	W <sub>2</sub>	3max
P <sub>2</sub>	6.35±1.30	H	Approx. 22
φd	0.60 <sup>+0.06</sup> / <sub>-0.05</sub>	H <sub>0</sub>	17.0±0.5
F	5.0±0.5	φD <sub>0</sub>	φ4.0±0.2
Δh	0±2	t	0.6±0.3
W	18.0 <sup>+1.0</sup> / <sub>-0.5</sub>	L	11max
φD	Z5D: 7max, Z7D: 8.5max		

Straight Leads and Taped  
Z7D□□□ T4D

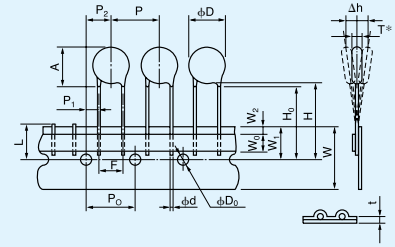

\*Dimension "T": Conforms to each individual specification  
\*Packing quantity: 1000pcs/BOX

P	12.7±1.0	W <sub>0</sub>	5.0min
P <sub>0</sub>	12.7±0.3	W <sub>1</sub>	9.0±0.5
P <sub>1</sub>	3.85±0.70	W <sub>2</sub>	3max
P <sub>2</sub>	6.35±1.30	H	Approx. 20
φd	0.60 <sup>+0.06</sup> / <sub>-0.05</sub>	H <sub>0</sub>	17.0±0.5
F	5.0±0.5	φD <sub>0</sub>	φ4.0±0.2
Δh	0±2	t	0.6±0.3
W	18.0 <sup>+1.0</sup> / <sub>-0.5</sub>	L	11max
		φD	Z5D: 7max, Z7D: 8.5max

Unit(mm)