



Protecting Supply Chains  
Worldwide with **Trusted Security  
Seals and Tamper Evident  
Solutions** since 1992.

**Security Packaging**



Universeal UK, 9 Portal Business Park,  
Eaton Lane, Tarporley, Cheshire, CW6 9DL



[www.universeal.co.uk](http://www.universeal.co.uk)

# About us

**Universeal UK is a manufacturer and distributor of a full range of anti-tamper / tamper-evident security seals and tamper-evident packaging.**

Universeal UK Ltd. is part of the worldwide Universeal Group of Companies. We combine to offer a comprehensive, competitive and innovative range of security seals and tamper-evident packaging for all sectors of industry and commerce.

## Our Company

With over 30 years' experience and thousands of satisfied customers, we pride ourselves in our friendly, knowledgeable approach. Whatever the security requirement, big or small we offer a fast, reliable service and second-to-none value for money products.

Universeal UK Ltd. is part of the worldwide Universeal Group of Companies; our partner networks extends across France, Ireland, South Africa, Australia, Canada, Japan, and USA. We combine to offer a comprehensive, competitive and innovative range of security seals and services for all sectors of industry and commerce.

Our Security Packaging range is trusted to protect cash, documents, clinical samples, pharmaceuticals, evidence, spare parts, confidential records, returns and other sensitive items in transit. From tamper-evident envelopes and cash bags to UN3373-compliant packaging, desiccants and secure carry cases, we have the experience to recommend the right solution for your movement and storage needs. Backed by over 30 years in the industry, we offer a responsive, knowledgeable service and great value products to help keep contents secure from dispatch to delivery.

### Service

**We are a small, friendly team who will go above and beyond to help our customers.**

Our comprehensive product knowledge can help find the solution that fits your enquiry, be it large or small and we pride ourselves in our fast, efficient service.

**We are here to support you, online, on the phone or in person!**

### Certification & Global Reach

The majority of our products are manufactured in ISO 9001 and ISO 14001 certified production facilities. Copies of certification are available upon request.

We have production facilities within the UK, Europe, North America and the Far East and sales teams within the UK, Europe and North America ready to support your requirements.

# Table of Contents

<b>Security Packaging</b>	<b>3</b>
Security Bags, Envelopes & Pouches	4
Moisture Absorbing Desiccants	10
Secure Transport & Logistics	11
UN3373 Category B / P650 Packaging	16
Healthcare Clinical Waste Bags	19
Eco-Friendly Bags & Mailers	21
Tote Boxes & Plug Seals	24
Transport & Storage Carry Cases	26

# Security Packaging

Security packaging is a broad category of tamper-evident and protective packaging which can assist organisations in ensuring the safe transport of goods and cargo in transit. Our specialist packaging products protect against many types of risks when transporting goods, including water ingress, shock protection, and more.

- SECURITY BAGS, ENVELOPES & POUCHES
- MOISTURE ABSORBING DESICCANTS
- SECURE TRANSPORT & LOGISTICS
- UN3373 CATEGORY B / P650 PACKAGING
- HEALTHCARE CLINICAL WASTE BAGS

- ECO-FRIENDLY BAGS & MAILERS
- TOTE BOXES & PLUG SEALS
- PACKAGING TAPE AND LABELS
- TRANSPORT & STORAGE CARRY CASES



## Industries

-  GOVERNMENT & CUSTOMS
  AIRLINES & AVIATION
  ASSET & INSPECTION
  HEALTHCARE
  TRANSPORT & LOGISTICS
  FOOD & PHARMACEUTICAL
-  INDUSTRIAL & MANUFACTURING
  CASH & VALUABLES HANDLING
  RETAIL & HOSPITALITY
  UTILITIES & ENERGY
  WASTE COLLECTION

# Security Bags, Envelopes & Pouches

Security bags, envelopes and pouches are tamper-evident solutions designed to protect items in transit or storage. Tamper proof bags and envelopes reduce the risk of transporting many types of sensitive items, providing an additional layer of security and a deterrent to potential theft or fraud. Choose from polythene single-use envelopes for secure mailing, healthcare samples and cash deposits, or durable reusable secure pouches ideal for internal mail and cash-in-transit operations. Each bag is designed to provide clear tamper evidence, with features such as VOID closures, sequential numbering and barcode tracking, ensuring traceability and compliance. Standard sizes include A5, A4 and A3, with flat or gusseted options, while custom printing is available (for example, see our customised security bags).

Security bags are commonly used as secure mail bags (e.g. for sealing confidential documents like exam papers); as cash deposit bags (AKA "cash-in-transit" /"CIT" bags); and as security bags for clinical items and police evidence. Our secure tamperproof bags and envelopes reduce the risk of transporting many types of valuable or sensitive items, providing an additional layer of security and a deterrent to potential theft or fraud. Our solutions deliver trusted security for organisations across logistics, healthcare, retail, banking, government and law enforcement.



## C5 / A5 Mail Security Bags (180x260mm)

**SKU:** UV007-A5

A5 Single-Use Tamper-evident Security Bags for Secure Mail, Evidence & Valuables.

- C5 Size (180mm x 260mm) to snugly fit bundles of A5 documents
- High-quality and durable, with secure tamper-evident closure to notify of opening or tampering. Tear-resistant, freeze-resistant and heat-resistant.

**Applications:** Secure packaging and mailing of valuable assets, personal effects and sensitive mail.

**Product Size Guide:** A5 size (180x260mm + 30mm dual tear-off receipts)

**Material:** PCR Polythene (55mic thickness)

**Pack Size:** Bag-100 / Carton-500

**Colour:** Standard stock colours: clear or opaque / Full range of colours available on request (minimum orders may apply)

### Sustainability

80% Recycled Material | 100% recyclable

### Industry



## C4 / A4 Mail Security Bags (255x360mm)

**SKU:** UV007-A4

A4 Single-Use Tamper-evident Security Bags for Secure Mail, Evidence & Valuables

- C4 Size (255mm x 360mm) to snugly fit bundles of A4 documents
- High-quality and durable, with secure tamper-evident closure to notify of opening or tampering. Tear-resistant, freeze-resistant and heat-resistant.

**Applications:** Secure packaging and mailing of valuable assets, personal effects and sensitive mail.

**Product Size Guide:** A4 size (255x360mm + 30mm dual tear-off receipts)

**Material:** PCR Polythene (55mic thickness)

**Pack Size:** Bag-100 / Carton-500

**Colour:** Standard stock colours: clear or opaque / Full range of colours available on request (minimum orders may apply)

### Sustainability

100% Recyclable | 80% Recycled Material

### Industry

## Security Bags, Envelopes & Pouches



### C3 / A3 Mail Security Bags (330x475mm)

**SKU:** UV007-A3

A3 Single-Use Mail Security bags with tamper seal for bulkier items and parcels.

- C3 Size (330x475mm) to snugly fit large bundles of A3 documents or whole parcels.

- High-quality and durable, with secure tamper-evident closure to notify of opening or tampering. Tear-resistant, freeze-resistant and heat-resistant.

**Applications:** Secure packaging and mailing of valuable assets, personal effects and sensitive mail.

**Product Size Guide:** A3 Size (330 x 475 + 30 mm dual tear-off receipts)

**Material:** PCR Polythene (55mic thickness)

**Pack Size:** Bag-100 / Carton-500

**Colour:** Standard stock opaque / Full range of colours available on request (minimum orders may apply)

#### Sustainability

100% Recyclable

**Industry**

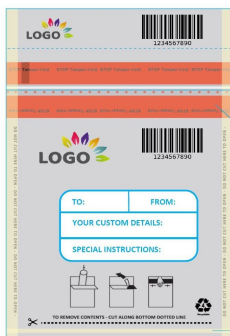

### Customised Tamper-evident Security Bags

**SKU:** UV007CUST

Fully customised single-trip security bags for secure transport of confidential items. 100% recyclable material.

- Highly secure sealing closure system protects against intrusion attempts.

**Applications:** Secure transit of courier and diplomatic mail, examination papers, crime scene forensic evidence, money and valuables, personal property etc.

**Customisation Options:** High level of customisation possible – including size, material thickness, tear-off receipts, carrier handles, print finishes and barcoding options. Please refer to product guide.

**Product Size Guide:** Custom sizes from 50-1000mm as required by application.

**Material:** LDPE material, 50-150 micron thickness. Available in transparent or opaque.

**Colour:** Up to 12 colour print (flexographic printing)

#### Sustainability

100% Recyclable

**Industry**



### Re-usable, Tamper-evident Cash Bags

**SKU:** UVTEB-CCB

Tamper-evident money bags for reliable cash-in-transit, valuables and retail use.

- Reusable and eco-friendly security bags for cash, valuables and more.

- Zip mechanism sealed using security seals, supplied separately.

**Applications:** Currency transportation, cash-in-transit, cash storage, valuables storage, internal cash movements, cash floats, key holding operations.

**Customisation Options:** Please contact us to discuss your customisation requirements.

**Product Size Guide:** Three sizes: (S) 178x152x50mm / (M) 267x267x50mm / (L) 356x267x50mm

**Material:** PVC-coated polyester

**Pack Size:** Individual Bags

**Colour:**

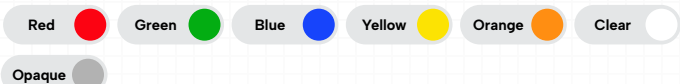

#### Sustainability

Reusable

**Industry**

## Security Bags, Envelopes & Pouches



### Sustainability

Reusable

Industry

## Re-usable & Secure Key Wallets

**SKU:** UVTEB-KW

Secure tamper-evident key wallets for controlled keyholding.

- Durable reusable key wallet / key pouch.
- Reusable hundreds of times — sustainable key control solution.
- Zip mechanism sealed using security seals, supplied separately.

**Applications:** Secure keyholding and storage applications, including car dealerships and rental companies, vehicle fleet and property management.

**Customisation Options:** Please contact us to discuss your customisation requirements.

**Product Size Guide:** 23x15cm

**Material:** PVC-coated polyester

**Pack Size:** Individual Bags

**Colour:** Blue back, clear front, Fully translucent back and front



### Sustainability

Reusable

Industry

## Re-usable Internal Mail Pouches

**SKU:** UVTEB-IMP

Colour-coded, internal mail pouches for movements and handling.

- Internal mail pouch with choice of six colour strips.
- Re-usable and sustainable security solution.
- Zip mechanism for secure closure.

**Applications:** Internal mail applications.

**Customisation Options:** Please contact us to discuss your customisation requirements.

**Product Size Guide:** Small: 36x26cm, Large: 41x31cm

**Material:** PVC-coated polyester

**Pack Size:** Individual Pouches

**Colour:** Semi-transparent webbed material, with choice of 6 colour strips: red, blue, green, yellow, orange and black



### Sustainability

Reusable

Industry

## Flat Security Mail Pouch (Long-edge zip)

**SKU:** UVTEB-FPL

Durable reusable mailing pouch for secure transport of sensitive mail and documents. Closure across long edge.

- Zip mechanism sealed using security seals, supplied separately.

**Applications:** Internal mailing & external mailing, document storage, sensitive document security, smaller document mailing.

**Customisation Options:** Please contact us to discuss your customisation requirements, Text Print, Barcoding, Logo.

**Product Size Guide:** Three sizes: (S) 406x305mm / (M) 457x356mm / (L) 508x406mm

**Material:** PVC-coated polyester

**Pack Size:** Individual Pouches

**Colour:** Red Green Blue Yellow Orange Pink

## Security Bags, Envelopes & Pouches



### Sustainability

Reusable

Industry

### Flat Security Mail Pouch (Short-edge zip)

**SKU:** UVTEB-FPS

Low-cost secure mailing for smaller mail items and documents. Zip closure across short edge.

- Re-usable and sustainable packaging solution.
- Zip mechanism sealed using security seals, supplied separately.

**Applications:** Internal mailing & external mailing, document storage, sensitive document security, smaller document mailing.

**Customisation Options:** Please contact us to discuss your customisation requirements, Text Print, Logo, Barcoding.

**Product Size Guide:** Three sizes: (S) 336x286mm / (M) 381x355mm / (L) 470x355mm

**Material:** PVC-coated polyester

**Pack Size:** Individual Pouches

**Colour:** Red  Green  Blue  Yellow  Orange



### Sustainability

Reusable

Industry

### Security Mailing Pouches (Full Gusset)

**SKU:** UVTEB-GP3/4

Reusable and secure mailing pouches for bulkier items and documents, with full-gusset.

- Full-gusset secure pouches for bulkier items.
- Zip mechanism sealed using security seals, supplied separately.

**Applications:** Internal mailing & external mailing, document storage, sensitive document security, smaller document mailing.

**Customisation Options:** Please contact us to discuss your customisation requirements, Text Print, Barcoding, Logo.

**Product Size Guide:** Four sizes: (S) 335x250x75mm / (M) 406x305x75mm / (L) 457x355x75mm / (XL) 457x355x125mm

**Material:** PVC-coated polyester

**Pack Size:** Individual Bags

**Colour:** Red  Green  Blue  Yellow  Orange  Pink



### Sustainability

Reusable

Industry

### Security Mailing Pouches (Bottom Gusset)

**SKU:** UVTEB-FPL

Secure mailing pouches for heavy documents, with bottom gusset.

- Heavyweight, bottom gusset mailing pouch.
- Zip mechanism sealed using security seals, supplied separately.

**Applications:** Internal mailing & external mailing, document storage, sensitive document security, smaller document mailing.

**Customisation Options:** Please contact us to discuss your customisation requirements.

**Product Size Guide:** Two sizes available: (S) 380x335x75mm / (L) 470x335x75mm

**Material:** PVC-coated polyester

**Pack Size:** Individual Bags

**Colour:** Red  Green  Blue  Yellow  Orange

## Security Bags, Envelopes & Pouches



### Sustainability

Reusable

Industry

### Tamper-evident Security Holdalls

**SKU:** UVTEB-H

Reusable security holdalls for tamper-evident bulk transport of valuables, documents & equipment.

- Heavy-duty handle for strength & durability.
- Zip mechanism sealed using security seals, supplied separately.

**Applications:** Valuables storage & transportation, bulky item storage & transportation.

**Customisation Options:** Please contact us to discuss your customisation requirements, Text Print, Barcoding, Logo.

**Product Size Guide:** Three sizes: (S) 406x305x203mm / (M) 508x356x152mm / (L) 584x406x254mm

**Material:** PVC-coated polyester

**Pack Size:** Individual Bags

**Colour:** Red Green Blue Yellow Orange



### Sustainability

Reusable

Industry

### Button Seals for Security Pouches

**SKU:** UVPOUCH-BS

Button seals for securing cash bags & mailing pouches. Standard or customised.

- Tamper-evident button seal designed for reusable security bags.
- Securely seals the locking chamber of zip closure.

**Applications:** Currency transportation, cash-in-transit, mailing pouches, confidential mail security.

**Customisation Options:** Please contact us to discuss your customisation requirements.

**Material:** Polypropylene

**Pack Size:** Cartons of 500

**Colour:** Red Green Blue Yellow Orange White



### Sustainability

Reusable

Industry

### Medical Pharmacy Bags

**SKU:** UVTEB-M21

Tamper-evident padded pharmacy bag for secure transfer of prescriptions between wards and departments.

- Tamper-evident pharmacy transport and return bag.
- Zip mechanism sealed using security seals, supplied separately.

**Applications:** Secure transit of controlled drugs, patient prescriptions or records.

**Customisation Options:** Text Print, Logo, Barcoding, Please contact us to discuss your customisation requirements.

**Product Size Guide:** Two sizes available: 41x31x10cm pouch or 46x36x15cm carrier with handles.

**Material:** PVC-coated polyester

**Pack Size:** Individual Bags

**Colour:** Green with yellow detailing

## Security Bags, Envelopes & Pouches



### Sustainability

Reusable

Industry  

### Secure Cytotoxic Drug Bags

**SKU:** UVTEB-MI

Reusable tamper-evident cytotoxic bags for controlled handling of toxic or hazardous drugs.

- Secure tamper-evident cytotoxic drug transport bags.
- Zip mechanism sealed using security seals, supplied separately.

**Applications:** Secure transit of controlled drugs, patient prescriptions or records.

**Customisation Options:** Text Print, Barcoding, logo.

**Product Size Guide:** 46x36x10cm size, with handles.

**Material:** PVC-coated polyester

**Pack Size:** Individual Bags

**Colour:** Green  Yellow 

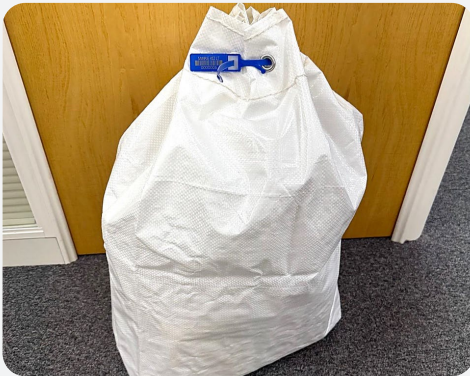

### Sustainability

100% Recyclable

Industry  

### Heavy-duty Woven PP Security Sacks

**SKU:** UVTEB-WPP7763W

Strong heavy-duty sacks in durable woven PP material, with eyelets for security sealing. 50KG+ weight limit.

- Eyelets can be used in conjunction with security seals.

**Applications:** Bulk transport of sealed produce, finished goods, industrial equipment, consumer items, etc.

**Customisation Options:** Full customisation with company logos, text, etc.

**Product Size Guide:** Bespoke sizes available. Standard: 70cm tall x 63cm wide. 15cm side and base gussets.

**Material:** Woven Polypropylene (PP)

**Pack Size:** Bundles of 25

# Moisture Absorbing Desiccants

Moisture absorbing desiccant packs protect goods against damage caused by moisture. Damp, humid conditions can damage goods, cause mould growth, promote metal corrosion, and deface / degrade packaging. This is of particular concern when transporting goods in shipping containers – variations in atmospheric pressures globally can cause containers to trap high levels of humidity, posing a risk to cargo during their long journeys globally. Our desiccants are particularly effective in absorbing this moisture within ambient air inside shipping containers, ensuring that cargo remains dry and free from damage caused by humidity.



Industry 

## Container Desiccant - 1000g Hook

**SKU:** VV1000

1000gram Hook – Hanging Moisture Absorbing Desiccant Packs for Shipping Containers.

- 1000g Hook packs hang from lashing points in recesses of shipping container walls, retaining valuable space for cargo.

**Applications:** Moisture absorbent for shipping containers and storage enclosures.

**Product Size Guide:** 125g – 1500g absorbent packs

**Material:** Calcium chloride / modified starch absorbent. Anti-leakage paper / back side PE film with adhesive.

**Pack Size:** Cartons (SKU specific)



Industry 

## Container Desiccant - 500g Strip

**SKU:** VV500

500gram Strip – Moisture Absorbing Desiccant Packs for Shipping Containers & Pallets. Protect from Cargo Damage.

- Versatile 500gram Strip configuration – can be hung in shipping containers or stuck on the top of pallets and crates.

**Applications:** Moisture absorbent for shipping containers and storage enclosures.

**Product Size Guide:** 125g – 1500g absorbent packs

**Material:** Calcium chloride / modified starch absorbent. Anti-leakage paper / back side PE film with adhesive.

**Pack Size:** Cartons (SKU specific)



Industry 

## Carton/ Pallet Desiccant - 125g

**SKU:** VV125

125gram Single – Moisture Absorbing Desiccants for Cartons & Pallets. Protect Goods from Water Damage.

- 125gram packs for moisture control inside cartons, pallets & crates.

**Applications:** Moisture absorbent for shipping containers and storage enclosures.

**Product Size Guide:** 125g – 1500g absorbent packs

**Material:** Calcium chloride / modified starch absorbent. Anti-leakage paper / back side PE film with adhesive.

**Pack Size:** Cartons (SKU specific)

# Secure Transport & Logistics

Our secure transport packaging products help to provide safe and secure transit of your goods, ensuring that valuable cargo arrives at its destination in pristine condition free from damage which can be caused in international freight movements. Our wide range of solutions can provide cargo protection across many types of consignments, including secure transit and shipment of individual items such as clothing garments, parcels, crates, pallets, tote boxes and shipping containers. This includes protection from exposure to moisture with our container desiccant bags; protection from mishandling with our shock and tilt indicator labels; well as the supply of dunnage bags which help to keep cargo securely stowed in shipping containers and HGV trailers.

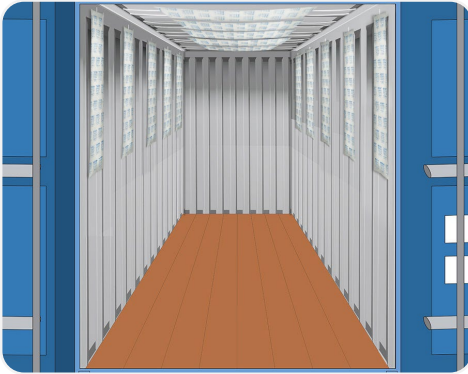

Industry  

## Shipping Container Desiccant Bags

**SKU Range:** VV125 – VV1000

Moisture Absorbing Desiccant Packs for Shipping Containers. Protect valuable goods from damage.

- Desiccant bags absorb water from the ambient air, reducing the humidity levels with shipping containers to protect cargo from damage.

**Applications:** Moisture absorbent for shipping containers and storage enclosures.

**Product Size Guide:** 125g – 1500g absorbent packs

**Material:** Calcium chloride / modified starch absorbent. Anti-leakage paper / back side PE film with adhesive.

**Pack Size:** SKU-specific



Industry  

## Tilt Indicator Cargo Labels

**SKU:** UVINDT

Tilt indicator labels monitor for unacceptable tilting of cargo which must remain upright.

- Tilt indication labels for wide ranging application to sensitive cargo in transit.
- Reduces losses caused by mishandling during transportation or storage.

**Applications:** Safe handling of pallets, export cases etc in many sectors, including automotive, precision components, furniture, scientific, medical and electrical industries.

**Product Size Guide:** 120x120mm

**Material:** Acrylic Adhesive

**Pack Size:** Carton of 50pcs

**Colour:** Yellow 



Industry  

## Shock Indicator Cargo Labels

**SKU:** UVINDS

Shock indicator labels. Monitor sensitive cargo to protect against mishandling during transit.



- Shock labels watch for excessive force beyond 15g, 25g, 37g, 50g, 75g and 100g force level.

**Applications:** Safe handling of pallets, export cases etc in many sectors, including automotive, precision components, furniture, scientific, medical and electrical industries.

**Product Size Guide:** 96 x 96mm

**Material:** Acrylic Adhesive

**Pack Size:** Carton of 100

**Colour:** Blue  Yellow  Purple  Red  Orange  Green   
15G      25G      37G      50G      75G      100G

## Secure Transport & Logistics



Industry   

### U-Temp Temperature Data Logger

**SKU:** UVTEMP

USB temperature data logger for cold chain monitoring. Accurate temperature tracking for pharmaceutical & food sectors.

- Pre-configured, compact single-use USB temperature data logger
- Wide temperature measuring range: -30°C to +60°C
- 2-year shelf life / 60 day operation – simply press button to start monitoring
- Built-in PDF/CSV report generation – no software needed
- EN12830 compliant for food and pharma supply chains

**Applications:** Temperature logging for pharmaceutical, food & beverage transportation.

**Customisation Options:** Customised Branding available (subject to MOQ)



Industry 

### Repair-a-Patches for Curtain Sided Trailers

**SKU:** UVRP

Curtain Sided Trailer Repair Kits, with self-adhesive patch to repair damage to tarpaulins.

- Quick and durable repair solution for your curtain-sided trailers.
- Available in 19 colours to match your tarpaulin.

**Applications:** Tarpaulin curtain sides.

**Product Size Guide:** Options available – 45x32cm patch; 220x22cm roll; 220x14cm roll.

**Pack Size:** Individual

**Colour:** Stock Colours: Red H7446, Blue H941, Silver H7300, Yellow H7462, Green H7333 and Transparent H000 / Full List of 19 Colours Available – Please See Colour Chart.



Industry  

### Trailer TIR Cords

**SKU:** UVTIR-2200

TIR cords for curtain-side vehicles

- Suitable for use with plastic and metal security seals

**Applications:** Securing curtain side vehicle buckles – can be used in conjunction with a security seal on back of vehicle.

**Customisation Options:** Customisation: custom length.

**Material:** Galvanised steel and plastic coating.

**Product Size Guide:** 6mm diameter x 16.5mt, 22mt, 34mt and 36.5mt lengths (custom lengths also available)

**Colour:**

## Secure Transport & Logistics



Industry  

### StrapSecure Pallet Seal

**SKU:** UVSTRAP

Innovative seal for increased security of pallets in transit

- Fits all popular sizes of strapping (6-15mm wide)

**Applications:** Pallet and carton security, customs movements.

**Customisation Options:** Laser-print: Logos, barcodes, text, bespoke number ranges.

**Material:** Cable seal: ABS plastic and non pre-formed galvanised aircraft cable / Cross-plate: Aluminium.

**Product Size Guide:** Cable: 1.5mm diameter / 200mm length Plate (sealed): 37mm diameter.

**Useable Length:** 250mm, Custom

**Break strength:** 50 KGF

**Security Level:** Indicative

**Pack Size:** Cartons of 150

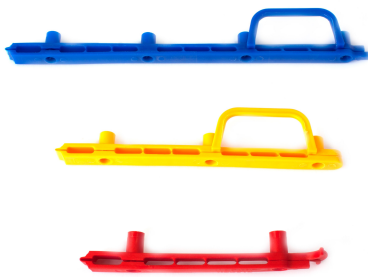

 **Sustainability**

100% Recyclable

Industry  

### Coathanger Set Seal For Garments

**SKU:** UVHANGER-210

Tamper-evident clothing separator seal keeps clothes secure and crease-free.

- Coathanger set seals are simple to apply, without tools.
- Garments cannot be removed without breaking the seal.
- Reduced scope for missing or stolen items.

**Applications:** Garment transportation

**Product Size Guide:** Available in three operating lengths: 102mm, 145mm & 205mm.

**Useable Length:** 210mm

**Material:** Polypropylene

**Pack Size:** Cartons of 500

**Colour:**  Red 



Industry  

### GarmentShield Clothing Security Tags

**SKU:** UV003GS

Anti-wardrobing security tags to reduce fraudulent clothing / garment returns.

- Protect your sales against unfair consumer behaviour.
- Tamper-evident design – tag must be removed to wear garment.

**Applications:** Online & clothes retailers – anti-wardrobing of clothes, shoes and other items.

**Customisation Options:** Ink-print: Full customisation options available.

**Security Level:** Indicative

**Product Size Guide:** 30mm x 100M tape roll / 70x30mm labels – customisation available

**Pack Size:** Rolls of Tape and Labels

## Secure Transport & Logistics

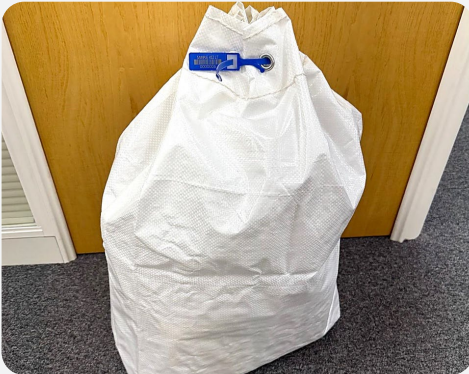

### Sustainability

100% Recyclable

Industry

## Heavy-duty Woven PP Security Sacks

**SKU:** UVTEB-WPP7763W

Strong heavy-duty sacks in durable woven PP material, with eyelets for security sealing. 50KG+ weight limit.

- Eyelets can be used in conjunction with security seals.

**Applications:** Bulk transport of sealed produce, finished goods, industrial equipment, consumer items, etc.

**Customisation Options:** Full customisation with company logos, text, etc.

**Product Size Guide:** Bespoke sizes available. Standard: 70cm tall x 63cm wide. 15cm side and base gussets.

**Material:** Woven Polypropylene (PP)

**Pack Size:** Bundles of 25



### Sustainability

100% Recyclable

Industry

## CrocLoc Tote Box Plug Seal

**SKU:** UV732

Tote box plug seals, produced in mats of 6pcs. Customisable with bespoke logos and barcoding.

- High-quality recyclable plug / arrow lock seal for crates, attached lid containers and tote boxes.

**Applications:** Sealing tote boxes and attached lid containers, for secure storage, transportation and archival operations.

**Customisation Options:** Choice of colours and full customisation, including logos and barcoding.

**Material:** Polypropylene

**Product Size Guide:** Approx 40x12x20mm

**Security Level:** Indicative

**Pack Size:** Carton of 3000pcs

**Colour:** Red  White  Blue  Yellow

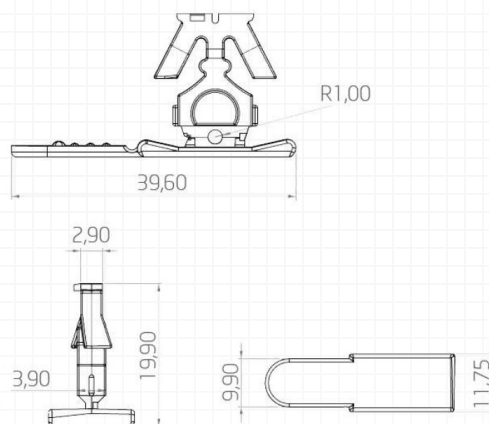

## Secure Transport & Logistics

### SK1 Plug Seals for Tote Boxes

**SKU:** UVPLUG-SK1

Tamper-evident plug seals for tote boxes. Plain, numbered & paired options.

- Designed for tote boxes, crates, and ALC containers

**Applications:** Sealing tote boxes and attached lid containers, for secure storage, transportation and archival operations.

**Customisation Options:** Laser-printed logos, numbering / bar-coding options. Can also be produced in a paired version – with sequential numbering in duplicate.

**Material:** Polypropylene

**Product Size Guide:** 35mm tab length / 24mm locking depth.

**Security Level:** Indicative

**Pack Size:** Pack of 1,000 / Carton of 5,000pcs

**Colour:** Red Blue White Yellow Green

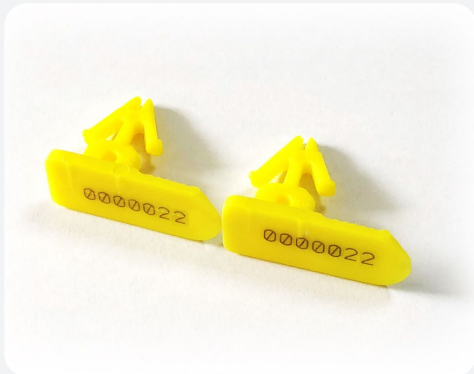

#### Sustainability

100% Recyclable

**Industry**  

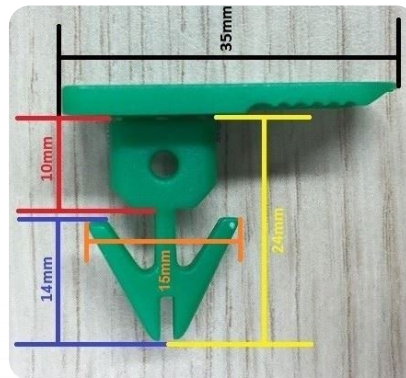

# UN3373 Category B / P650 Packaging

Secondary packaging containers for transport of infectious substances under UN3373 Category B and P650 packaging regulations. Secondary siftproof and leakproof packaging, including our SecureLab range of leakproof pouches, can be used as secondary containers within the UN3373 triple packaging system, for the transportation of primary containers containing specimen samples – including blood, swab and stool samples in medical, diagnostic and laboratory settings.

Our 95Kpa bags are specifically designed to meet the criteria for transporting Category B infectious substances under UN3373 regulations. These bags ensure the integrity and safety of biological samples by providing a robust, leakproof, and pressure-resistant secondary packaging solution. Ideal for medical, diagnostic, and laboratory settings, they are essential for compliance with Class 6.2 dangerous goods transport requirements.



## Sustainability

100% Recyclable

Industry

## SecureLab 95 - ADR Specimen Bags for Transport by Road

**SKU:** UV007SL-A5

95kPa Medical Specimen Bags for Transport of Infectious Substances by Road. UN3373 Compliant.

- Tested as a 95-kPa pressure-resistant P650 secondary container
- Suitable for road transport of infectious substances / lab specimens by road (ADR provisions)

**Applications:** UN3373 Category B packaging for 'infectious substances' / medical specimen transportation.

**Product Size Guide:** Inside Sizes: A4: 206x320mm / A5: 156x235mm. A3 and A6 sizes on request.

**Material:** LDPE

**Customisation Options:** Available with full customisation – MOQ's apply.

**Pack Size:** Packs of 100pcs



## Sustainability

100% Recyclable

Industry

## SecureLab 95 - IATA Specimen Bags for Transport by Air

**SKU:** UV007SL-IATAM

Medical Specimen Bags suitable for transport by air under IATA Regs. Compliant with UN3373 & PI650 Requirements.

- Tested as a 95-kPa pressure-resistant PI650 secondary container.
- Suitable for transport of infectious substances / lab specimens, including by air transport.
- Includes absorbent pad as standard.

**Applications:** UN3373 Category B packaging for 'infectious substances' / medical specimen transportation IATA approved for air travel.

**Product Size Guide:** Available in A6, A5 or A4 (internal sizes)

**Material:** LDPE

**Customisation Options:** Available with full customisation – MOQ's apply.

**Pack Size:** 500pcs

## UN3373 Category B / P650 Packaging



### SecureLab Biohazard Bags with Document Pouch, 152x140mm

**SKU:** UV007SLBIO

Specimen Bags for transport of blood, urine & stool samples to pathology laboratories.

- Resealable Specimen Bag with Pouch, 152x140mm Size.
- Marked with Highly Visible Biohazard Sign, Yellow and Red Design.

**Applications:** Transport of blood, tissue, urine & stool specimen samples to pathology & laboratory departments.

**Product Size Guide:** Bag: 152x140mm / Document Pouch: 152x203mm

**Material:** LDPE

**Customisation Options:** Available with full customisation – MOQ's apply.

**Pack Size:** Cartons of 1,000

**Colour:** Clear / transparent material

#### Sustainability

100% Recyclable

**Industry**  



### Absorbent Pads

**SKU:** UV007PAD

Absorbent Pads for containing infectious substances in transit under UN3373 regulations

- Absorbent Sheet 65x110mm, capable of absorbing 50ml of liquid

**Applications:** UN3373 / P650 sample specimen packaging, transport of infectious substances under dangerous goods regulations.

**Product Size Guide:** 65x110mm as standard / 50ml absorbency – other sizes/ absorption capacity on request.

**Material:** Super Absorbent Paper

**Pack Size:** Bundles of 100pcs

**Industry**   

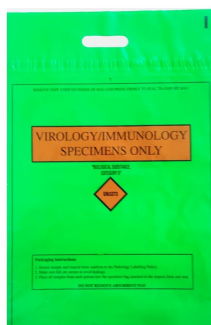

### Laboratory Specimen Transport Bags

**SKU:** UV007LB

Flexible UN3373 laboratory specimen outer transport bags.

**Applications:** Safe transport of medical specimens to laboratories.

**Material:** LDPE

**Industry**  

## UN3373 Category B / P650 Packaging



### Sustainability

Reusable

Industry  

## SecureLab CHILL - Insulated Medical Carrier

**SKU:** UVTEB-IMC1

UN3373 rugged and insulated medical carrier for laboratory specimen transport.

- Highly bespoke carriers, with a choice of six colours and customisable lids available.

**Applications:** Secure transport of pathology specimens and other medical samples.

**Customisation Options:** Please contact us to discuss your customisation requirements.

**Product Size Guide:** Three sizes: Small (305x305x170mm), Medium (406x305x255mm), Large (650x380x255mm)

**Material:** PVC-coated polyester

**Pack Size:** Individual Bags

**Colour:**

Red



Green



Blue



Yellow



Orange



Purple



# Healthcare Clinical Waste Bags

Using the appropriate UN3291-certified clinical waste sacks within medical and hospital facilities is a crucial health and safety requirement mandated by UK and international regulations for safe transport and disposal of hazardous waste. Clinical waste is separated into different streams depending on its contents and should be disposed in the relevant alternative treatment, incineration or landfill facilities depending on the likely risks to human health. The clinical waste bag categories shown below (yellow, orange, tiger stripe and domestic waste sacks) are the most popular ranges, accounting for 95% of the clinical waste produced in the medical sector.



Industry  

## Orange Clinical Waste Sacks

**SKU:** UVCWO

Orange clinical waste sacks for infectious human waste.

- Co-extruded and star sealed using advanced co-extrusion technology.
- 5kg, 8kg, 10kg and 12kg UN 3291 approved weight sacks.

**Applications:** Sealing of clinical waste bags and sacks in medical, veterinary, dental and pharmaceutical sectors.

**Material:** Co-extruded, star-sealed material according to UN requirements.



Industry  

## Yellow Clinical Waste Sacks

**SKU:** UVCWY

Yellow clinical waste sacks for contaminated and infectious human waste.

- Co-extruded and star sealed using advanced co-extrusion technology.
- 5kg, 8kg, 10kg and 12kg UN 3291 approved weight sacks.

**Applications:** Sealing of clinical waste bags and sacks in medical, veterinary, dental and pharmaceutical sectors.

**Material:** Co-extruded, star-sealed material according to UN requirements.



Industry  

## Tiger Stripe Clinical Waste Sacks

**SKU:** UVCWT

Tiger stripe offensive waste sacks for non-infectious waste

- Advanced co-extruded materials for strength and leak protection
- Available in 70L and 90L capacities

**Applications:** Sealing of clinical waste bags and sacks in medical, veterinary, dental and pharmaceutical sectors.

**Material:** Advanced co-extruded materials for strength and leak protection.

## Healthcare Clinical Waste Bags



CLEAR AND BLACK  
WASTE SACKS – FOR  
DOMESTIC WASTE

### Clear and Black Domestic Waste Sacks

**SKU:** UVCWB

Clear and black sacks for domestic waste, printed 'Household Waste only'

- Available in clear and black options
- Pre-printed 'Household Waste Only'

**Applications:** Disposal of domestic types of waste, including packaging, etc.

**Material:** Polythene

Industry  

# Eco-Friendly Bags & Mailers

Our range of environmentally sustainable security, ecommerce and mail order bags offer greener, lower carbon packaging alternatives to traditional virgin plastic bags used in security and commercial applications, without sacrificing quality and weather-resistance. The range includes bags manufactured from compostable materials (including materials such as PLA); renewable sugar plastics (such as 'I'm green' polyethylene derived from sugar cane); recycled-content bags (containing at least 80% post-consumer recycled plastic); as well as reusable PVC security bags, which can be used hundreds of times over a long lifespan.

## Custom Courier Paper Mailers

**SKU:** UV007CUST

Custom Courier Paper Mailers for eCommerce. 100% Plastic Free. Bespoke sizes and print.

- Paper-based mailers, bespoke to order.
- 100% plastic-free ecommerce mailer.

**Applications:** Courier, ecommerce, secure mail.

**Customisation Options:** Fully bespoke

**Material:** Paper, 80-110 GSM

**Product Size Guide:** Custom Sizes: 120x170mm - 500x550mm



### Sustainability

Biodegradable

Industry



Sequential barcode

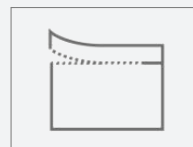

Perforation

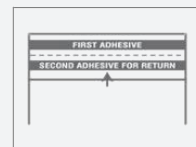

2 time use return bags

## Custom Paper + Compostable Mailers

**SKU:** UV007CUST

Custom Courier Paper Mailers for eCommerce. 100% Plastic Free. Bespoke sizes and print.

- Paper and compostable mailers, bespoke to order
- 100% plastic-free ecommerce mailer

**Applications:** Courier, ecommerce, secure mail.

**Customisation Options:** Fully bespoke

**Material:** Paper, 80-110 GSM

**Product Size Guide:** Custom Sizes: 120x120mm to 800x1040mm

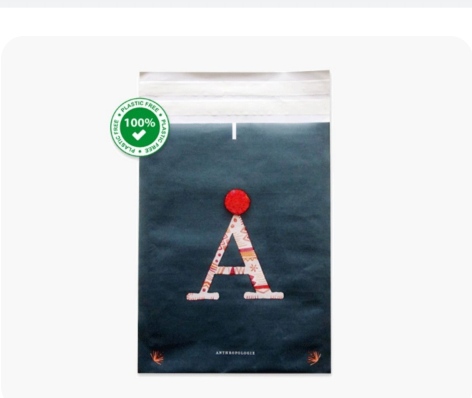

### Sustainability

Biodegradable

Industry



Sequential barcode

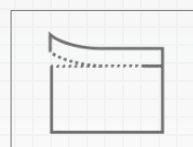

Perforation

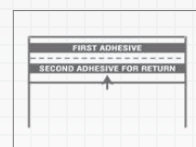

2 time use return bags

## Eco-Friendly Bags & Mailers



### Compostable Mailers

**SKU:** UV007CUST

Custom compostable mailers for eCommerce and courier logistics. Bespoke sizes and print.

- Bags combining the strength of traditional plastic with sustainability of compostable materials.
- Highly customisable. Wide range of bespoke features available.

**Applications:** Courier, ecommerce, secure mail

**Customisation Options:** Fully bespoke

**Material:** Paper, 80–110 GSM

**Product Size Guide:** Custom sizes: 120x170mm to 580x710mm

**Industry**



### Recycled Content Courier Mailers

**SKU:** UV007CUST

Custom mailers for eCommerce and courier logistics, with up to 80% recycled plastic.

- Bags combining the strength of traditional plastic with a lower carbon footprint.
- Highly customisable. Wide range of bespoke features available.

**Applications:** Courier, ecommerce, secure mail

**Customisation Options:** Fully bespoke

**Material:** 50–150 Micron

**Product Size Guide:** Custom sizes: 120x120mm to 800x1040mm

**Sustainability**  
30% Recycled Material

**Industry**



Sequential barcode

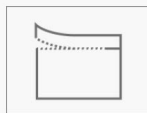

Perforation

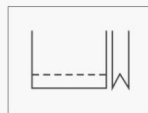

Bottom gusset

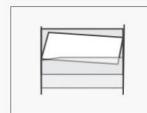

Airway bill pouch (jacket)

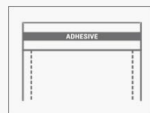

Twin seal

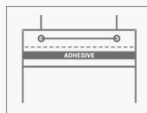

Wicket bags

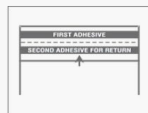

2 time use return bags



Easy tear frustration free bags

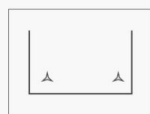

Star punch / Air removal



Top open with D-cut handle



Bottom open with D-cut handle

## Eco-Friendly Bags & Mailers

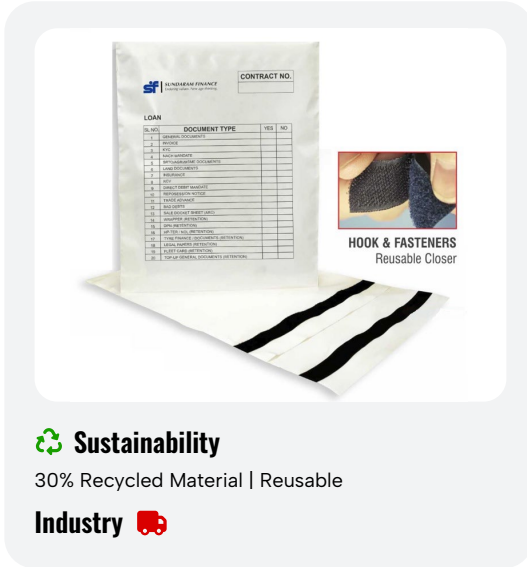

### Reusable Custom Velcro Pouches

SKU: UV007CUST

Velcro / "hook and loop" pouches for mail, documents and commercial items. Customised to your requirements.

- Multi-use velcro pouches, highly customisable.
- Writable surfaces.

**Applications:** Document retention, courier / mail applications, apparel packaging.

**Customisation Options:** Fully bespoke

**Material:** 50-150 Micron

**Product Size Guide:** Custom sizes: 120x120mm to 480x550mm.

**Sustainability**

30% Recycled Material | Reusable

**Industry**

# Tote Boxes & Plug Seals

Our security tote boxes, otherwise known as ALC's (attached lid containers), and plug seals are the perfect solution for the secure storage and transport of many kinds of bulk items, inventory and documents for archive. Our ALC tote boxes are available in a range of colour and size options, including popular 28ltr, 43ltr, 55ltr and 80ltr sizes. Our plug seals (also known as 'tote box seals', 'arrow lock seals' and 'crate seals') are available from UK stocks in multiple colours with/without security barcode numbering, or alternatively can be customised with your own information. Security tote seals are often used in the pharmaceutical sector to protect hazardous or dangerous substances, and in the retail sector for the protection and storage of merchandise.

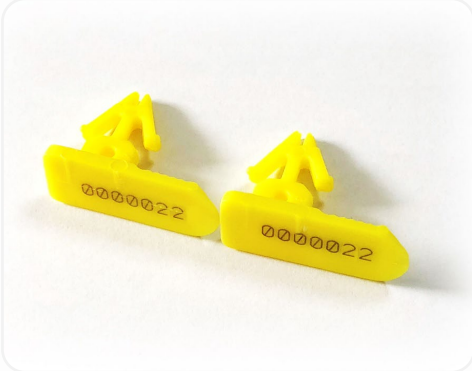

## Sustainability

100% Recyclable

Industry  

## SK1 Plug Seals for Tote Boxes

**SKU:** UVPLUG-SK1

Tamper-evident plug seals for tote boxes. Plain, numbered & paired options.

- Designed for tote boxes, crates, and ALC containers

**Applications:** Sealing tote boxes and attached lid containers, for secure storage, transportation and archival operations.

**Customisation Options:** Laser-printed logos, numbering / bar-coding options. Can also be produced in a paired version - with sequential numbering in duplicate.

**Material:** Polypropylene

**Security Level:** Indicative

**Product Size Guide:** 35mm tab length / 24mm locking depth.

**Pack Size:** Pack of 1,000 / Carton of 5,000pcs

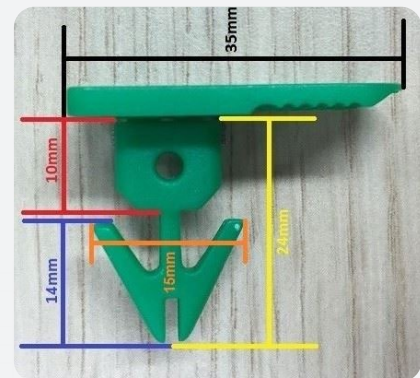

## Sustainability

100% Recyclable

Industry  

## CrocLoc Tote Box Plug Seal

**SKU:** UV732

Tote box plug seals, produced in mats of 6pcs. Customisable with bespoke logos and barcoding.

- High-quality recyclable plug / arrow lock seal for crates, attached lid containers and tote boxes.

**Applications:** Sealing tote boxes and attached lid containers, for secure storage, transportation and archival operations.

**Customisation Options:** Choice of colours and full customisation, including logos and barcoding.

**Material:** Polypropylene

**Security Level:** Indicative

**Product Size Guide:** Approx 40x12x20mm

**Pack Size:** Carton of 3000pcs

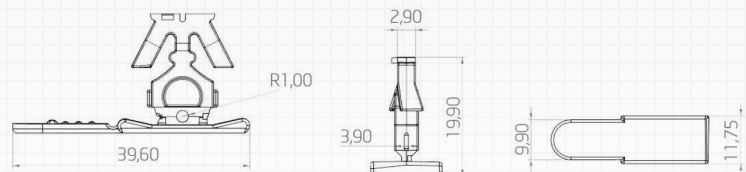

## Tote Boxes & Plug Seals



Industry 

### Unitote ALC boxes (25-80L)

**SKU:** UVT-ALC25

Unitote ALCs – secure storage and transport (sizes from 25–80L)

- Nestable when empty and stackable when full.
- Suitable for use with security plug seals.

**Applications:** Secure storage, secure & protective transportation, secure archiving.

**Customisation Options:** Printed text, logos, sequential numbers, barcoding. RFID Tracking Chip. Bespoke alterations and detailing available.

**Material:** Polypropylene

**Product Size Guide:** Popular Sizes – 25ltr: 400x300x306mm / 54ltr: 600x400x320mm / 64ltr: 600x400x365mm

**Colour:**

Grey

Black

Red

Blue

Yellow

Green

Brown

Orange

Purple

# Transport & Storage Carry Cases

Sturdy transport & storage carry cases are available in multiple sizes, configurations, colours and customisation options. Protective transport cases are used for many types of applications and use cases, including for use as first aid boxes, medical cases, spill kit cases, power tool cases, product presentation cases, packing cases, hobby cases and more. Cases can be produced with detailed customised prints where preferred.



Industry 

## Medical Carry Cases

**SKU:** PEL85

Moulded plastic carry cases, suitable for first aid and medical applications.

- Lightweight but durable medical case.
- Available in range of opaque or transparent colours.

**Applications:** Cases for First aid, Medical, Spill Kit Applications.

**Customisation Options:** White/ Black Custom Print to Front / Reverse of Case

**Product Size Guide:** Large: 47x33x12cm / Small: 36x31x12cm

**Material:** Polypropylene

**Colour:** Red Green Blue Yellow Orange Black



Industry 

## Medical Carry Cases

**SKU:** PEL85

Large, heavy-duty moulded plastic carry cases suitable for customisation.

- Durable and sturdy protective transport case.
- Available with a range of customisation options.

**Applications:** Cases for First aid, Medical, Spill Kits, Power Tools, Product Presentation, Packing and Hobbies.

**Customisation Options:** White/ Black Custom Print to Front / Reverse of Case

**Product Size Guide:** Large: 47x33x12cm / Small: 36x31x12cm

**Material:** Polypropylene

**Colour:** Red Green Blue Yellow Orange Black



Protecting Supply Chains Worldwide with  
**Trusted Security Seals and Tamper  
Evident Solutions** since 1992.

📍 **Universeal UK, 9 Portal Business Park,  
Eaton Lane, Tarporley, Cheshire, CW6 9DL**

🌐 **[www.universeal.co.uk](http://www.universeal.co.uk)**

✉ **[sales@universeal.co.uk](mailto:sales@universeal.co.uk)**

☎ **+44 (0) 1829 760000**