



Classic 1m Steplift

A cost-effective lift with
up to one metre of travel



A reliable, cost-effective steplift

Classic 1m Steplift

The new Classic 1 metre Steplift boasts a smaller footprint along with an increased load capacity - now capable of lifting 280kg to a maximum of 1m between two floors.

With increased clear access, the hydraulically driven, scissor based platform is suitable for both internal and external environments. Functional yet stylish, our Classic 1m Steplift moves quietly between levels to provide safe and reliable access in public buildings and in the home. Further key features include an on-board drive and powered upper and lower gates combined with the ramp (no pit).

New model	Battery operation
Smaller footprint	Higher carrying capacity

► Features

- Pump unit is integrated within the lift offering reduced vandalism risk
- No need for separate control unit or pump location
- Easy access to pump for servicing
- Easier and faster to install
- Simpler to use
- More compact
- New stylish protective bellows - more rigid/durable
- Improved IP 67 rated switching (waterproof) with easy service access
- Easy to use emergency lowering system
- 1 day installation - minimal builders work
- Can be relocated
- Low maintenance

► Sectors

 Public Access

 At Home

► Platform Sizes

800 x 1400mm

900 x 1400mm

1100 x 1400mm

► Options

- | | |
|-----------------|------------------------------------|
| Gate | ■ Automatic upper gate |
| | ■ Automatic lower gate |
| | ■ On board ramp |
| | ■ Auto closers |
| Controls | ■ Full braille controls |
| | ■ Autodialler |
| | ■ Alarm |
| | ■ Keyswitch |
| | ■ Keyswitch isolation |
| | ■ Remote controls |
| | ■ Full ambulant user controls |
| | ■ Full controls at serviced floors |
| Finish | ■ Remote call posts |
| | ■ Handrails |
| | ■ Coloured safety flooring |
| | ■ Silicon acrylic infill panels |
| | ■ Aluminium infill panels |
| ■ Custom colour | |

➤ Configurations

Through Entry

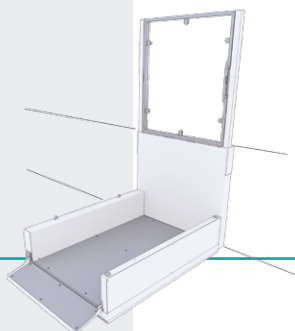

All measurements are in millimetres (mm)

Models	Internal Dims	External Dims*
800 standard	800 x 1400	980 x 1695
900	900 x 1400	1080 x 1695
1100	1100 x 1400	1280 x 1695

* Ramp/No Upper - 1695 Ramp & Upper - 1755

Adjacent Entry/Exit

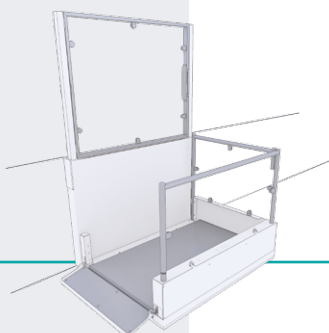

Models	Internal Dims	External Dims*
800 standard	800 x 1400	980 x 1695
900	900 x 1400	1080 x 1695
1100	1100 x 1400	1280 x 1695

* Ramp/No Upper - 1695 Ramp & Upper - 1755

Bridging Steps

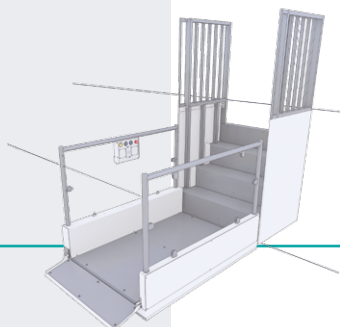

Models	Internal Dims	External Dims*
800 standard	800 x 1400	980 x 1695
900	900 x 1400	1080 x 1695

* Ramp/No Upper - 1695 Ramp & Upper - 1755

Pit Mounted

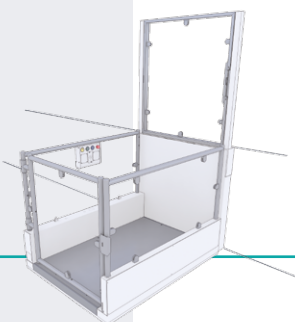

Models	Internal Dims	External Dims*
800 standard	800 x 1400	980 x 1455
900	900 x 1400	1080 x 1455
1100	1100 x 1400	1280 x 1455

* Lower Gate/No Upper - 1455 Lower & Upper Gate - 1505

Bespoke Option

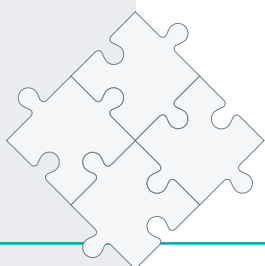



We can create a Steplift that is bespoke to your needs. We will assist with site requirements and advise on regulations and legislation (e.g. platform sizes, control requirements etc). We will ensure that your lift not only performs exactly as you want, but also looks exactly how you need it to.

› Technical Specifications

Location	Internal or External environments
Usage	Public or domestic use by ambulant and wheelchair users
Maximum passengers	Wheelchair user plus attendant (lower gate required)
Lift Safe Working Load	280kg
Platform Sizes (w) x (l)	800 x 1400mm 900 x 1400mm 1100 x 1400mm
Design & Manufacturing Standard	BS 6440:2011; EN 81-41(ref. only) Machinery Directive 2006/42/EC

The comprehensive ranges ...

	 Public Access	 At Home	 Service & Goods
1m Steplift Classic	✓	✓	
1m Steplift Executive	✓	✓	
Independence Steplift 2m/3m	✓	✓	
Incline Platform Lift	✓	✓	
Passenger Lift	✓		
Vertical Platform Lift	✓		
Through Floor Lift		✓	
Residential Elevator		✓	
Residential Stair Lift		✓	
Service Lift			✓
Goods Lift			✓
Dumb Waiter			✓