

AS Series: The new diameter 160x50/60 mm with black hub

Description

The AS series range widens thanks to the **new diameter 160x50/60** with **black thermoplastic hub** and soft polyurethane coating hardness 87 ± 3 Shore A.



Technical specifications

Art. N.	35026
Diameter (D)	160
Tread width (E)	50
Hub width (L)	60
Bearing seat (s x t)	47 x 17
Bore diameter (d)	20
Distance between outer faces of bearings (V)	54
Hub diameter (M)	60
Load capacity kg	500

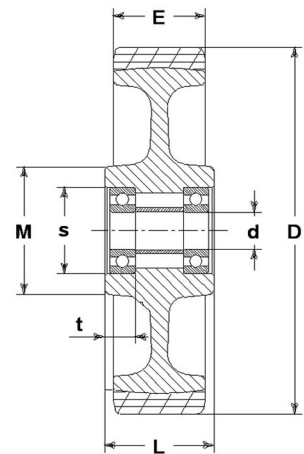

Strengths

- Reinforced hub and wider tread ensures better performances
- New dark look; ideal for theatre equipment
- Ball bearings for smooth rolling
- Higher load capacity: 500kg
- Non marking

Market/applications



Theatres



Logistic and material handling

AS Series: The new diameter 160x50/60 mm with black hub

Forks

The new AS series wheel diameter 160x50/60 with black hub is ideally paired with the following forks:







- **P60** heavy (max load capacity 500kg)
- **M40** medium-heavy (max load capacity 450 kg)
- **M22** medium (max load capacity 300kg)

All swivel castors are also available in the version with brake.

Art. N.







P60



	Total height	208 mm
	Load capacity	500 kg
	Swivel fork	36223
	Swivel fork with trailing foot brake	36223FR
	Swivel fork with leading foot brake	36223FV
	Fixed fork	36323







M40



	Total height	207 mm
	Load capacity	450 kg
	Swivel fork	36023
	Swivel fork with trailing foot brake	36023FR
	Swivel fork with leading foot brake	36023FV
	Fixed fork	36123

M22



	Total height	196 mm
	Load capacity	300 kg
	Swivel fork	36423
	Swivel fork with trailing foot brake	36423FR
	Fixed fork	36523
	Swivel bolt hole fork assembly	36623FE 36623FG
	Swivel bolt hole fork assembly with foot brake	36623FRFE

Recommendations and warnings: http://www.lagspa.eu/web/aggiornamenti/download/EN_CGRA.pdf



LAG S.p.A.

Via del Lavoro, 17 • Z.I. La Graziosa
41018 San Cesario sul Panaro (MO)
Italy • tel. +39 059 585425
sales@lagspa.it • www.lagspa.it

*passion for
movement.*

