

Uniclass L74 735	EPIC K712
CI/Sfb (62X) (63) X	

# Hamilton® GRID-IT

**NEW**

**Linea-CFX®**  
Concealed Fixing  
Frames and Plates



*Sheer* CFX®  
Concealed Fixing  
Flat Plates



**Hartland CFX®**  
Concealed Fixing  
Slim Plates



*Sheer*®  
Flat Plates



**Hartland®**  
Slim Plates



**CHERITON®**  
Georgian  
and Victorian  
Design Plates

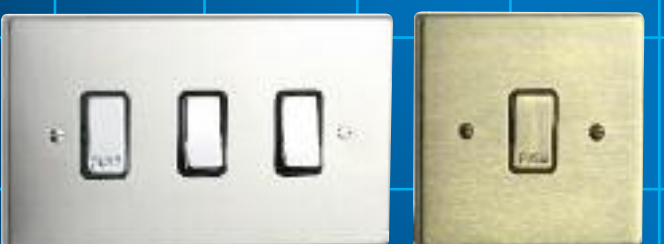
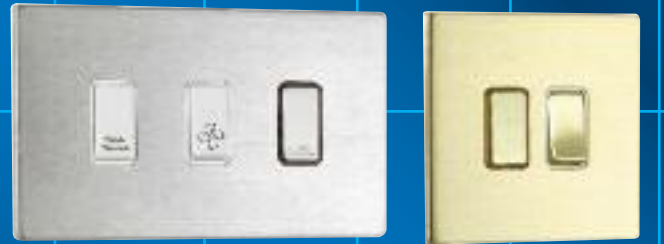
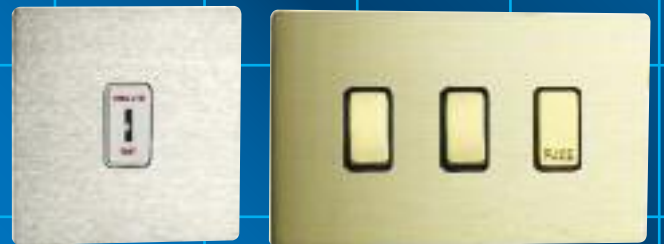
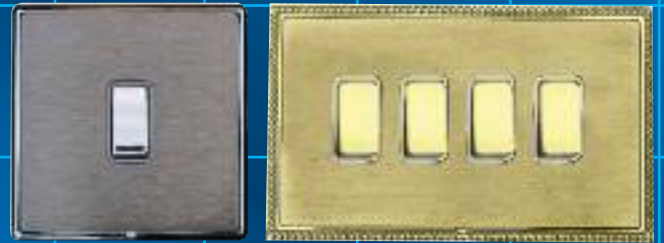

**Hamilton®** making grid connections - *easy!*

**NEW** Linea-CFX Concealed Fixing Flat Plates in 5 designs and 7 finishes



Sheer Flat Plates in 10 finishes

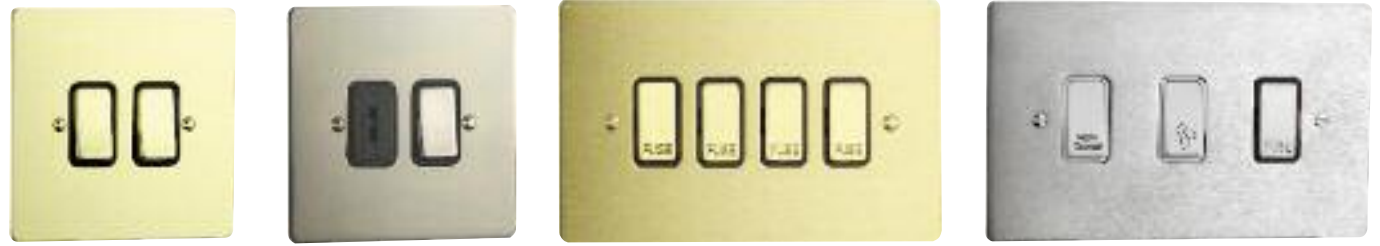

Sheer CFX Concealed Fixing Flat Plates in 6 finishes

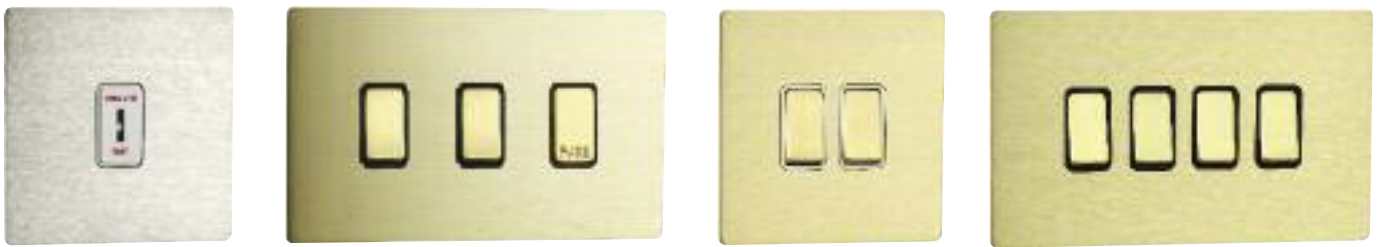

Hartland Slim Plates in 10 finishes



Hartland CFX Concealed Fixing Slim Plates in 6 finishes



Cheriton Georgian and Victorian Design Plate in 5 finishes



Contents	Page
<b>Rocker Switch Modules</b> 10 Finishes, 2 Way 20AX Double Pole 20AX Intermediate 20AX Push To Make/Break 10AX Non Retractive 2 Way 20AX and Off	4
<b>20AX Double Pole Rocker Switch Modules with Printed Names/Symbols</b>	4-5
Boiler Hob Cooker Hood Micro Wave Dish Washer Oven Fan Symbol Tumble Dryer Freezer Waste Disposal Fridge Water Heater Heater Washing Machine Wine Cooler	
<b>10AX Push to Make Rocker Modules</b> Printed Bell Push	5
<b>400W Dimmer Module</b> Push On/Off Resistive	6
<b>Push On/Off Switch Modules</b> 3 types	6
<b>High Frequency Ballast Control Module</b> 1-10V DC	6
<b>Grid Dimmer Insert Kits</b> 8 Knob Finishes with Frames and Screws	6
<b>Trailing Edge Touch Master Dimmer Modules</b> Multi-way, 7 Finishes	7
<b>Touch Slave Controller Modules</b> For use only with Touch Master Dimmers	7
<b>Trailing Edge Touch Push On/Off Modules</b> 6 Finishes	7
<b>Fuse Modules</b> 10 Finishes, 4 halo colours	8
<b>Cable Outlet Modules</b>	8
<b>Neon Halo Modules</b> 10 Finishes, 4 halo colours	8
<b>Neon Only Modules</b> 4 colours	9
<b>Hotel Maid Service Neon Modules</b> Printed Symbols and Messages	9
<b>Key Switch Modules</b> 2 Way 20AX Double Pole 20AX 2 Way 20AX printed "EMG LTG TEST" Spare Key	9
<b>Blanking Module Inserts</b> 10 Finishes	9
<b>Spare Insert Frames</b> 1, 2, 3 & 4 gang	10
<b>Spare Screws for Plates and Back Boxes</b>	10
<b>1 gang 13A Socket Modules with attached Fixing Grids</b> 10 Finishes	10-11
<b>2 gang 13A Socket Modules with attached Fixing Grids</b> 10 Finishes	11
<b>Linea-CFX Concealed Fixing Grid Fix Frame and Plates</b> 12-13 Linea-Rondo CFX 19 Mix or Match Finish Combinations Linea-Scala CFX and Linea-Duo CFX 18 Mix or Match Finish Combinations Rocker Switches 1, 2, 3, 4 gang Linea-Perlina CFX and Linea-Georgian 13 Mix or Match Finish Combinations Rocker Switches 1, 2, 3, 4 gang	
<b>Sheer Grid Fix Aperture Plates</b> 14 10 Finishes Rocker Switches 1, 2, 3, 4, 6, 8, 9 & 12 gang Switched Sockets 1 gang, 2 gang	
<b>Sheer CFX Concealed Fixing Grid Fix Aperture Plates</b> 6 Finishes 15 Rocker Switches 1, 2, 3 & 4 gang Spare Insert Frames	
<b>Hartland Grid Fix Aperture Plates</b> 16 10 Finishes Rocker Switches 1, 2, 3, 4, 6, 8, 9 & 12 gang Switched Sockets 1 gang, 2 gang	
<b>Hartland CFX Concealed Fixing Grid Fix Aperture Plates</b> 6 Finishes 17 Rocker Switches 1, 2, 3 & 4 gang Spare Insert Frames	
<b>Cheriton Grid Fix Aperture Plates</b> 18 Georgian and Victorian Designs, 5 Finishes Rocker Switches 1, 2, 3, 4, 6, 8, 9 & 12 gang Switched Sockets 1 gang, 2 gang	
<b>Technical Information</b>	19

# Hamilton® GRID-IT

## Grid Fix solutions to fit your installation requirements...

- Grid modules clip and screw for secure fixing
- 10 Module finishes to perfectly match the Plate finish
- Unique built-in neon on fuse - no need for an extra module
- Range of 16 annotated printed rocker switches
- Grids are zinc plated to prevent corrosion
- Grid frame earth terminal has 12mm<sup>2</sup> cable capacity
- 1, 2, 3, 4, 6, 8, 9 and 12 gang grid plates available
- 1 and 2 gang grid switched sockets
- Front plates match the latest Hamilton ranges:-  
5 **NEW** Linea-CFX Concealed Fixing Plate Styles in 7 finishes  
Sheer Flat Plates in 10 finishes  
Sheer CFX Concealed Fixing Flat Plates in 6 finishes  
Hartland Slim Plates in 10 finishes  
Hartland CFX Concealed Fixing Slim Plates in 6 finishes  
Cheriton Georgian and Victorian Design Plate in 5 finishes
- Quick and simple Installation

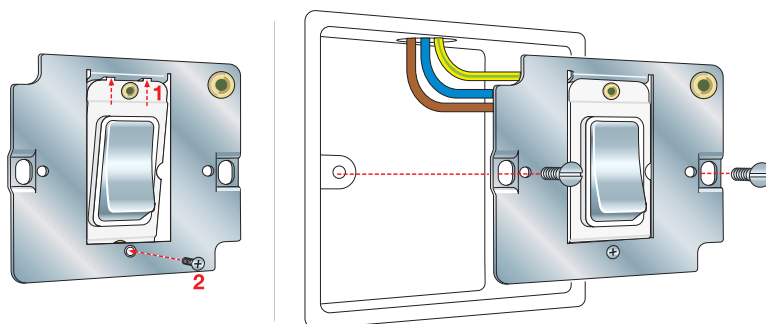

Insert the two lugs on the module upwards into the cut-outs in the grid and screw in the single retaining screw

Connect the wiring into the appropriate contacts and attach the grid to the back box using the two grid fix screws provided

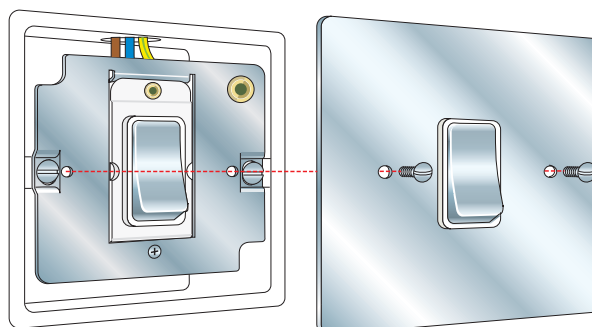

To complete the installation attach the Front Plate using the two screws provided.

# Hamilton® GRID-IT

## Rocker Switch Modules

	Pack Qty.	Min. Box Depth	Wall Depth	British Standard	Polished Brass /Black	Polished Brass /White	Satin Brass /Black	Satin Brass /White	Antique Brass /Black
2 Way 10AX	5	35 mm		BS EN 60669-1	I R21/10 PB/BL	I R21/10 PB/WH	I R21/10 SB/BL	I R21/10 SB/WH	I R21/10 AB/BL
2 Way 20AX	5	35 mm		BS EN 60669-1	I R21/20 PB/BL	I R21/20 PB/WH	I R21/20 SB/BL	I R21/20 SB/WH	I R21/20 AB/BL
Double Pole 20AX	5	35 mm		BS EN 60669-1	I 20DP PB/BL	I 20DP PB/WH	I 20DP SB/BL	I 20DP SB/WH	I 20DP AB/BL
Intermediate 20AX	5	35 mm		BS EN 60669-1	I R31/20 PB/BL	I R31/20 PB/WH	I R31/20 SB/BL	I R31/20 SB/WH	I R31/20 AB/BL
Push To Make/Break 10AX	5	35 mm		BS EN 60669-1	I PTM PB/BL	I PTM PB/WH	I PTM SB/BL	I PTM SB/WH	I PTM AB/BL
Non-Retractive 2 Way & Off 20AX	5	35 mm		BS EN 60669-1	I R2WO PB/BL	I R2WO PB/WH	I R2WO SB/BL	I R2WO SB/WH	I R2WO AB/BL
Retractive 2 Way & Off 10AX	5	35 mm		BS EN 60669-1	I RR2W PB/BL	I RR2W PB/WH	I RR2W SB/BL	I RR2W SB/WH	I R2WO AB/BL

	Pack Qty.	Min. Box Depth	Wall Depth	British Standard	Bright Chrome /Black	Bright Chrome /White	Satin Chrome /Black	Satin Chrome /White	Satin Stainless /Black	Satin Stainless /White
2 Way 10AX	5	35 mm		BS EN 60669-1	I R21/10 BC/BL	I R21/10 BC/WH	I R21/10 SC/BL	I R21/10 SC/WH	I R21/10 SS/BL	I R21/10 SS/WH
2 Way 20AX	5	35 mm		BS EN 60669-1	I R21/20 BC/BL	I R21/20 BC/WH	I R21/20 SC/BL	I R21/20 SC/WH	I R21/20 SS/BL	I R21/20 SS/WH
Double Pole 20AX	5	35 mm		BS EN 60669-1	I 20DP BC/BL	I 20DP BC/WH	I 20DP SC/BL	I 20DP SC/WH	I 20DP SS/BL	I 20DP SS/WH
Intermediate 20AX	5	35 mm		BS EN 60669-1	I R31/20 BC/BL	I R31/20 BC/WH	I R31/20 SC/BL	I R31/20 SC/WH	I R31/20 SS/BL	I R31/20 SS/WH
Push To Make/Break 10AX	5	35 mm		BS EN 60669-1	I PTM BC/BL	I PTM BC/WH	I PTM SC/BL	I PTM SC/WH	I PTM SS/BL	I PTM SS/WH
Non-Retractive 2 Way & Off 20AX	5	35 mm		BS EN 60669-1	I R2WO BC/BL	I R2WO BC/WH	I R2WO SC/BL	I R2WO SC/WH	I R2WO SS/BL	I R2WO SS/WH
Retractive 2 Way & Off 10AX	5	35 mm		BS EN 60669-1	I RR2W BC/BL	I RR2W BC/WH	I RR2W SC/BL	I RR2W SC/WH	I RR2W SS/BL	I RR2W SS/WH

	Pack Qty.	Min. Box Depth	Wall Depth	British Standard	Black Nickel /Black	Pearl Oyster /White	Black/Black	White/White
2 Way 10AX	5	35 mm		BS EN 60669-1	I R21/10 BK/BL	I R21/10 PO/WH	I R21/10 BL/BL	I R21/10 WH/WH
2 Way 20AX	5	35 mm		BS EN 60669-1	I R21/20 BK/BL	I R21/20 PO/WH	I R21/20 BL/BL	I R21/20 WH/WH
Double Pole 20AX	5	35 mm		BS EN 60669-1	I 20DP BK/BL	I 20DP PO/WH	I 20DP BL/BL	I 20DP WH/WH
Intermediate 20AX	5	35 mm		BS EN 60669-1	I R31/20 BK/BL	I R31/20 PO/WH	I R31/20 BL/BL	I R31/20 WH/WH
Push To Make/Break 10AX	5	35 mm		BS EN 60669-1	I PTM BK/BL	I PTM PO/WH	I PTM BL/BL	I PTM WH/WH
Non-Retractive 2 Way & Off 20AX	5	35 mm		BS EN 60669-1	I R2WO BK/BL	I R2WO PO/WH	I R2WO BL/BL	I R2WO WH/WH
Retractive 2 Way & Off 10AX	5	35 mm		BS EN 60669-1	I RR2W BK/BL	I RR2W PO/WH	I RR2W BL/BL	I RR2W WH/WH

# Hamilton® GRID-IT

## 20AX Double Pole Rocker Switch Modules with Printed Names/Symbols

	Pack Qty.	Min. Box Depth	Wall Depth	British Standard	Black /Black	White /White		Pack Qty.	Min. Box Depth	Wall Depth	British Standard	Black /Black	White /White	
Boiler	5	35 mm		BS EN 60669-1	I 20DPBO BL/BL	I 20DPBO WH/WH		5	35 mm		BS EN 60669-1	I 20DPCH BL/BL	I 20DPCH WH/WH	
Dish Washer	5	35 mm		BS EN 60669-1	I 20DPDW BL/BL	I 20DPDW WH/WH		Fridge	5	35 mm		BS EN 60669-1	I 20DPFG BL/BL	I 20DPFG WH/WH

# Hamilton GRID-IT

## 20AX Double Pole Rocker Switch Modules with Printed Names/Symbols

	Pack Qty.	Min. Wall Box Depth	British Standard	Black /Black	White /White		Pack Qty.	Min. Wall Box Depth	British Standard	Black /Black	White /White
Fan Symbol	5	35 mm	BS EN 60669-1	I 20DPFN BL/BL	I 20DPFN WH/WH	Freezer	5	35 mm	BS EN 60669-1	I 20DPFZ BL/BL	I 20DPFZ WH/WH
Hob	5	35 mm	BS EN 60669-1	I 20DPHO BL/BL	I 20DPHO WH/WH	Heater	5	35 mm	BS EN 60669-1	I 20DPHT BL/BL	I 20DPHT WH/WH
Micro Wave	5	35 mm	BS EN 60669-1	I 20DPMW BL/BL	I 20DPMW WH/WH	Oven	5	35 mm	BS EN 60669-1	I 20DPOV BL/BL	I 20DPOV WH/WH
Tumble Dryer	5	35 mm	BS EN 60669-1	I 20DPTD BL/BL	I 20DPTD WH/WH	Waste Disposal	5	35 mm	BS EN 60669-1	I 20DPWD BL/BL	I 20DPWD WH/WH
Water Heater	5	35 mm	BS EN 60669-1	I 20DPWT BL/BL	I 20DPWT WH/WH	Washing Machine	5	35 mm	BS EN 60669-1	I 20DPWM BL/BL	I 20DPWM WH/WH
Wine Cooler	5	35 mm	BS EN 60669-1	I 20DPWC BL/BL	I 20DPWC WH/WH						

# Hamilton GRID-IT

## 10AX Push to Make Rocker Switch Modules with Printed Names/Symbols

	Pack Qty.	Min. Wall Box Depth	British Standard	Black /Black	White /White
Bell Push	5	35 mm	BS EN 60669-1	I BP BL/BL	I BP WH/WH

All switches are X-Rated to eliminate the need to de-rate for fluorescent loads.

## 400W Dimmer Module

When using Mains Voltage Halogen Lamps - Dimmers should be de-rated by 25% - please refer to our Guide to Dimming about multi-gang ratings of Dimmer Modules

	Pack Qty.	Min. Wall Box Depth	Tungsten Filament and Halogen Rating	Tungsten Filament Rating	Halogen Rating	British Standard	Module
400W 2 Way Push On/Off Resistive Dimmer	5	35 mm	Min 40W per gang	Max 400W per gang	Max 300W per gang	BS EN 60669-2-1	I D4002

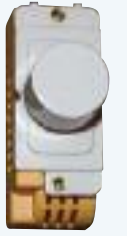

## Push On/Off Switch Modules

	Pack Qty.	Min. Wall Box Depth	Tungsten Filament and Halogen Rating	British Standard	Module	Module	Module
3A Intermediate Push On/Off Switch Module	5	35 mm	Max 3A per gang	BS 5733	I DIP		
6A 2 Way Push On/Off Switch Module	5	35 mm	Max 6AX per gang	BS EN 60669-1		I D5102	
1-10V Push On/Off Switch Module	5	35 mm	Min 0-10V Max per gang	BS EN 60669-1			I DRTW

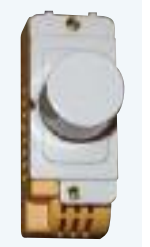
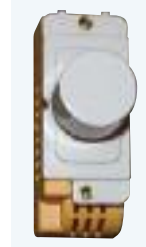

## High Frequency Ballast Control Module

Please refer to our Guide to Dimming

	Pack Qty.	Min. Wall Box Depth	Tungsten Filament and Halogen Rating	Module
1-10V DC Ballast Control (NO OFF)	5	35 mm	Max 50 Ballasts per Controller. 1-10V DC Control - NOT for connection to 230V Mains To be used in conjunction with a 20A 2 Way Rocker Switch	I DHF 10V

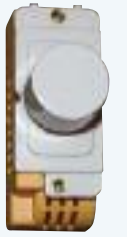

## Grid Dimmer Inlay Kits

Consisting of Black and White Frame with Matching Metal Inlay, Dimmer Knob and Retaining Ring



I DKIT PB - Polished Brass Knob and Insert



I DKIT SC - Satin Chrome Knob and Insert

	Pack Qty.	Polished Brass	Satin Brass	Antique Brass	Bright Chrome
Grid Dimmer Inlay Kit	5	I DKIT PB	I DKIT SB	I DKIT AB	I DKIT BC
	Pack Qty.	Satin Chrome	Satin Stainless	Black Nickel	Pearl Oyster
Grid Dimmer Inlay Kit	5	I DKIT SC	I DKIT SS	I DKIT BK	I DKIT PO

# Hamilton GRID-IT

## Trailing Edge Touch Master Multi-Way Dimmer Modules

Note: When using Wire Wound Inductive Load Transformers –  
Maximum Rating Is 210VA

	Pack Qty.	Min. Wall Box Depth	British Standard	Polished Brass /Black	Polished Brass /White	Satin Brass /Black	Satin Brass /White	Bright Chrome /Black	Bright Chrome /White
Trailing Edge Touch Master Multi-way Dimmers 250VA Max. 25W/VA Min. On/Off - Up/Down	5	35 mm	BS EN 60669-2-1	ID T250M PB/BL	ID T250M PB/WH	ID T250M SB/BL	ID T250M SB/WH	ID T250M BC/BL	ID T250M BC/WH



	Pack Qty.	Min. Wall Box Depth	British Standard	Satin Chrome /Black	Satin Chrome /White	Satin Stainless /Black	Satin Stainless /White	Black Nickel /Black	Antique Brass /Black
Trailing Edge Touch Master Multi-way Dimmers 250VA Max. 25W/VA Min. On/Off - Up/Down	5	35 mm	BS EN 60669-2-1	ID T250M SC/BL	ID T250M SC/WH	ID T250M SS/BL	ID T250M SS/WH	ID T250M BK/BL	ID T250M AB/BL



# Hamilton GRID-IT

## Touch Slave Controller Modules

Note: To be used only with Touch MasterDimmers

	Pack Qty.	Min. Wall Box Depth	British Standard	Polished Brass /Black	Polished Brass /White	Satin Brass /Black	Satin Brass /White	Bright Chrome /Black	Bright Chrome /White
Touch Slave Controllers On/Off - Up/Down	5	35 mm	BS EN 60669-2-1	ID TS PB/BL	ID TS PB/WH	ID TS SB/BL	ID TS SB/WH	ID TS AB/BL	ID TS BC/WH



	Pack Qty.	Min. Wall Box Depth	British Standard	Satin Chrome /Black	Satin Chrome /White	Satin Stainless /Black	Satin Stainless /White	Black Nickel /Black	Antique Brass /Black
Touch Slave Controllers On/Off - Up/Down	5	35 mm	BS EN 60669-2-1	ID TS SC/BL	ID TS SC/WH	ID TS SS/BL	ID TS SS/WH	ID TS BK/BL	ID TS AB/BL



# Hamilton GRID-IT

## Trailing Edge Push On/Off Modules

Note: When using Wire Wound Inductive Load Transformers –  
Maximum Rating Is 210VA

	Pack Qty.	Min. Wall Box Depth	British Standard	Polished Brass	Satin Brass	Bright Chrome	Satin Chrome	Satin Stainless	Black Nickel
Trailing Edge Push On/Off 250VA Max. 25W/VA Min.	5	35 mm	BS EN 60669-2-1	ID D250TR PB	ID D250TR SB	ID D250TR BC	ID D250TR SC	ID D250TR SS	ID D250TR BK



	Pack Qty.	Min. Wall Box Depth	British Standard	Antique Brass
Trailing Edge Push On/Off 250VA Max. 25W/VA	5	35 mm	BS EN 60669-2-1	ID D250TR AB

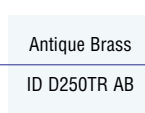

# Hamilton® GRID-IT

## Fuse Modules with four choices of Neon Halo Colour

Illustration of an illuminated  
Red Neon Halo shown actual size.



	Pack Qty.	Min. Wall Box Depth	British Standard	Polished Brass	Satin Brass	Antique Brass	Bright Chrome	Satin Chrome
13A Fuse + Red Neon Halo	5	35 mm	BS 5733	I FNR PB	I FNR SB	I FNR AB	I FNR BC	I FNR SC
13A Fuse + Amber Neon Halo	5	35 mm	BS 5733	I FNA PB	I FNA SB	I FNA AB	I FNA BC	I FNA SC
13A Fuse + Blue Neon Halo	5	35 mm	BS 5733	I FNB PB	I FNB SB	I FNB AB	I FNB BC	I FNB SC
13A Fuse + Green Neon Halo	5	35 mm	BS 5733	I FNG PB	I FNG SB	I FNG AB	I FNG BC	I FNG SC

### Replacement Fuses to BS 1362 Standard



	Pack Qty.	Min. Wall Box Depth	British Standard	Satin Stainless	Black Nickel	Pearl Oyster	Black	White
13A Fuse + Red Neon Halo	5	35 mm	BS 5733	I FNR SS	I FNR BK	I FNR PO	I FNR BL	I FNR WH
13A Fuse + Amber Neon Halo	5	35 mm	BS 5733	I FNA SS	I FNA BK	I FNA PO	I FNA BL	I FNA WH
13A Fuse + Blue Neon Halo	5	35 mm	BS 5733	I FNB SS	I FNB BK	I FNB PO	I FNB BL	I FNB WH
13A Fuse + Green Neon Halo	5	35 mm	BS 5733	I FNG SS	I FNG BK	I FNG PO	I FNG BL	I FNG WH

# Hamilton® GRID-IT

## 20A Cable Outlet Modules



	Pack Qty.	Min. Wall Box Depth	British Standard	Black	White
Cable Outlet	5	35 mm	BS5733	I CO20 BL	I CO20 WH

# Hamilton® GRID-IT

## Neon Halo Modules with four choices of Neon Halo Colour







	Pack Qty.	Min. Wall Box Depth	British Standard	Polished Brass	Satin Brass	Antique Brass	Bright Chrome	Satin Chrome
Red Neon Halo	5	35 mm	BS 5733	I NR PB	I NR SB	I NR AB	I NR BC	I NR SC
Amber Neon Halo	5	35 mm	BS 5733	I NA PB	I NA SB	I NA AB	I NA BC	I NA SC
Blue Neon Halo	5	35 mm	BS 5733	I NB PB	I NB SB	I NB AB	I NB BC	I NB SC
Green Neon Halo	5	35 mm	BS 5733	I NG PB	I NG SB	I NG AB	I NG BC	I NG SC



	Pack Qty.	Min. Wall Box Depth	British Standard	Satin Stainless	Black Nickel	Pearl Oyster	Black	White
Red Neon Halo	5	35 mm	BS 5733	I NR SS	I NR BK	I NR PO	I NR BL	I NR WH
Amber Neon Halo	5	35 mm	BS 5733	I NA SS	I NA BK	I NA PO	I NA BL	I NA WH
Blue Neon Halo	5	35 mm	BS 5733	I NB SS	I NB BK	I NB PO	I NB BL	I NB WH
Green Neon Halo	5	35 mm	BS 5733	I NG SS	I NG BK	I NG PO	I NG BL	I NG WH

# Hamilton® GRID-IT

## Neon Only Modules

	Pack Qty.	Min. Wall Box Depth	British Standard				
Neon Only	5	35 mm	BS 5733	I NO R	I NO A	I NO B	I NO G

# Hamilton® GRID-IT



## Hotel Maid Service Neon Modules

	Pack Qty.	Min. Wall Box Depth	British Standard				
Hotel Maid Service Neons	5	35 mm	BS 5733	I NOG MA	I NOR BE	I NOG PCR	I NOG DND

# Hamilton® GRID-IT

## Key Switch Modules Supplied with Key

	Pack Qty.	Min. Wall Box Depth	British Standard			
2 Way 20AX	5	35 mm	BS EN 60669-1	I K21/20 BL	I K21/20 WH	Pack Qty.
Double Pole 20AX	5	35 mm	BS EN 60669-1	I K20DP BL	I K20DP WH	Spare Key

	Pack Qty.	Min. Wall Box Depth	British Standard		
2 Way 20AX printed "EMG LTG TEST"	5	35 mm	BS EN 60669-1	I K21/20ELT BL	I K21/20ELT WH

# Hamilton® GRID-IT

## Blanking Modules

	Pack Qty.	Min. Wall Box Depth					
Blanking Module	5	35 mm	I BMOD PB/BL	I BMOD PB/WH	I BMOD SB/BL	I BMOD SB/WH	I BMOD AB/BL

	Pack Qty.	Min. Wall Box Depth						
Blanking Module	5	35 mm	I BMOD BC/BL	I BMOD BC/WH	I BMOD SC/BL	I BMOD SC/WH	I BMOD SS/BL	I BMOD SS/WH

	Pack Qty.	Min. Wall Box Depth				
Blanking Module	5	35 mm	I BMOD BK/BL	I BMOD PO/WH	I BMOD BL/BL	I BMOD WH/WH

## Spare Insert Frames For Sheer, Hartland and Cheriton Front Plates

See page 15 for Sheer CFX and page 17 for  
Hartland CFX Spare Insert Frames

	Pack Qty.	1 gang
1 Gang Spare Insert Frame	5	1G-GRID



	Pack Qty.	3 gang
3 Gang Spare Insert Frame	5	3G-GRID

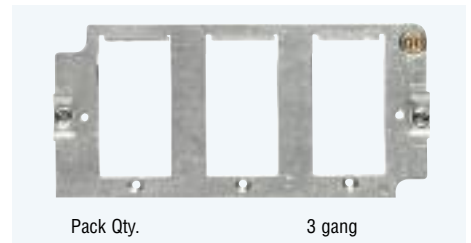

	Pack Qty.	2 gang
2 Gang Spare Insert Frame	5	2G-GRID



	Pack Qty.	4 gang
4 Gang Spare Insert Frame	5	4G-GRID

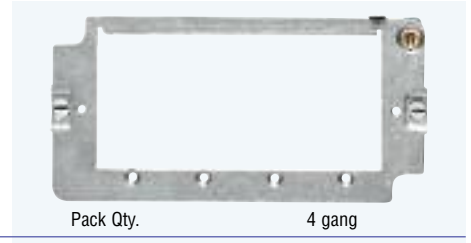

## Spare Plate Screws

	Size mm	Pack Qty.	Gloss White	Polished Brass	Satin Brass	Bright Chrome	Satin Chrome	Bright Stainless	Satin Stainless	Black Nickel	Pearl Oyster	Antique Brass
Spare Dome Headed Slotted Screws for Rocker/Aperture Plates	5mm x 3mm	50	PSGR WH	PSGR PB	PSGR SB	PSGR BC	PSGR PO	PSGR BC	PSGR PO	PSGR BK	PSGR PO	PSGR AB
Spare Countersunk Slotted Screws for switched Socket Plates	5mm x 3mm	50	PSGS WH	PSGS PB	PSGS SB	PSGS BC	PSGS PO	PSGS BC	PSGS PO	PSGS BK	PSGS PO	PSGS AB

## Spare Back Box Screws

	Size	Pack Qty.	Order Code
Spare Countersunk Slotted Bright Zinc Passivated Screws for Back Box	25mm x 3.5mm	50	SGBOX25
Spare Countersunk Slotted Bright Zinc Passivated Screws for Back Box	50mm x 3.5mm	50	SGBOX50

## Spare Rocker/Insert Screws

	Size	Pack Qty.	Order Code
Spare Countersunk Cross-Slotted Bright Zinc Passivated Screws for Grid Inserts	4mm x 2.5mm	50	SGINS

## 1 gang 13A Socket Inserts with attached Fixing Grids

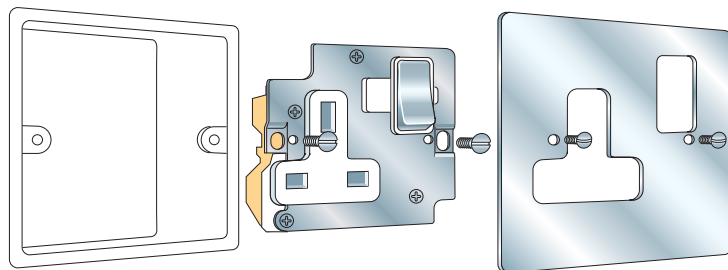

(See Technical Information  
for compatible Wall Boxes)

Insert Sockets  
Supplied with Frames  
complete with fixing screws

Surface Plates  
Supplied in boxes of 5  
complete with fixing screws

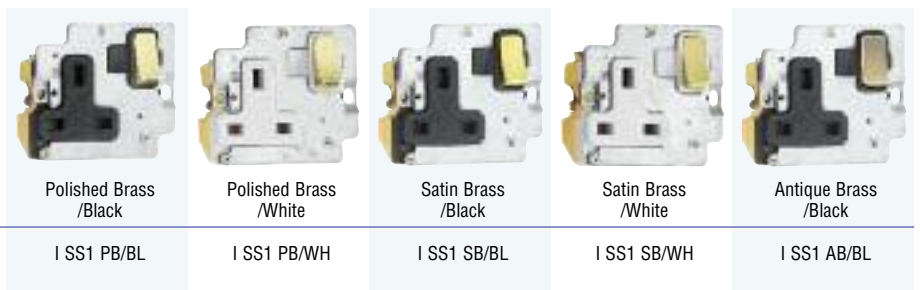

	Pack Qty.	Min. Wall Box Depth	British Standard	Polished Brass /Black	Polished Brass /White	Satin Brass /Black	Satin Brass /White	Antique Brass /Black
1 Gang 13A Double Pole Switched Socket	5	35 mm	BS 1363	I SS1 PB/BL	I SS1 PB/WH	I SS1 SB/BL	I SS1 SB/WH	I SS1 AB/BL





	Pack Qty.	Min. Wall Box Depth	British Standard	Bright Chrome /Black	Bright Chrome /White	Satin Chrome /Black	Satin Chrome /White	Satin Stainless /Black
1 Gang 13A Double Switched Socket	5	35 mm	BS 1363	I SS1 BC/BL	I SS1 BC/WH	I SS1 SC/BL	I SS1 SC/WH	I SS1 SS/BL

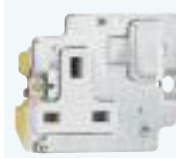

**1 gang 13A Socket Modules  
with attached Fixing Grids**

	Pack Qty.	Min. Wall Box Depth	British Standard					
1 Gang 13A Double Pole Switched Socket	5	35 mm	BS 1363	I SS1 SS/WH	I SS1 BK/BL	I SS1 PO/WH	I SS1 BL/BL	I SS1 WH/WH

**2 gang 13A Socket Modules  
with attached Fixing Grids**

	Pack Qty.	Min. Wall Box Depth	British Standard			
2 Gang 13A Double Pole Switched Socket	5	35 mm	BS 1363	I SS2 PB/BL	I SS2 PB/WH	I SS2 SB/BL

	Pack Qty.	Min. Wall Box Depth	British Standard			
2 Gang 13A Double Pole Switched Socket	5	35 mm	BS 1363	I SS2 SB/WH	I SS2 AB/BL	I SS2 BC/BL

	Pack Qty.	Min. Wall Box Depth	British Standard			
2 Gang 13A Double Pole Switched Socket	5	35 mm	BS 1363	I SS2 BC/WH	I SS2 SC/BL	I SS2 SC/WH

	Pack Qty.	Min. Wall Box Depth	British Standard			
2 Gang 13A Double Pole Switched Socket	5	35 mm	BS 1363	I SS2 SS/BL	I SS2 SS/WH	I SS2 BK/BL

	Pack Qty.	Min. Wall Box Depth	British Standard			
2 Gang 13A Double Pole Switched Socket	5	35 mm	BS 1363	I SS2 PO/WH	I SS2 BL/BL	I SS2 WH/WH

**Grid Fix Aperture Plates**

Complete with Fixing Grids and Plate Screws



Linea-Rondo CFX®



Linea-Scala CFX®



Linea-Duo CFX®

**Linea-Rondo CFX® Grid Fix Frames and Plates**

	Nominal Size mm	Pack Qty.	Polished Brass Frame/ Polished Brass Plate	Polished Brass Frame/ Satin Brass Plate	Polished Brass Frame/ Antique Brass Plate	Polished Brass Frame/ Bright Steel Plate	Polished Brass Frame/ Satin Steel Plate	Satin Brass Frame/ Satin Brass Plate	Satin Brass Frame/ Satin Steel Plate
1 Gang Grid Fix Frame and Plate	91.4 x 91.4	5	LRX 1GFP PB/PB	LRX 1GFP PB/SB	LRX 1GFP PB/AB	LRX 1GFP PB/BS	LRX 1GFP PB/SS	LRX 1GFP SB/SB	LRX 1GFP SB/SS
2 Gang Grid Fix Aperture Plate	91.4 x 91.4	5	LRX 2GFP PB/PB	LRX 2GFP PB/SB	LRX 2GFP PB/AB	LRX 2GFP PB/BS	LRX 2GFP PB/SS	LRX 2GFP SB/SB	LRX 2GFP SB/SS
3 Gang Grid Fix Aperture Plate	150.4 x 91.4	5	LRX 3GFP PB/PB	LRX 3GFP PB/SB	LRX 3GFP PB/AB	LRX 3GFP PB/BS	LRX 3GFP PB/SS	LRX 3GFP SB/SB	LRX 3GFP SB/SS
4 Gang Grid Fix Aperture Plate	150.4 x 91.4	5	LRX 4GFP PB/PB	LRX 4GFP PB/SB	LRX 4GFP PB/AB	LRX 4GFP PB/BS	LRX 4GFP PB/SS	LRX 4GFP SB/SB	LRX 4GFP SB/SS
	Nominal Size mm	Pack Qty.	Antique Brass Frame/ Satin Brass Plate	Antique Brass Frame/ Antique Brass Plate	Bright Chrome Frame/ Polished Brass Plate	Bright Chrome Frame/ Bright Steel Plate	Bright Chrome Frame/ Satin Steel Plate	Bright Chrome Frame/ Black Nickel Plate	Bright Chrome Frame/ Piano Black Plate
1 Gang Grid Fix Frame and Plate	91.4 x 91.4	5	LRX 1GFP AB/SB	LRX 1GFP AB/AB	LRX 1GFP BC/PB	LRX 1GFP BC/BS	LRX 1GFP BC/SS	LRX 1GFP BC/BK	LRX 1GFP BC/N
2 Gang Grid Fix Aperture Plate	91.4 x 91.4	5	LRX 2GFP AB/SB	LRX 2GFP AB/AB	LRX 2GFP BC/PB	LRX 2GFP BC/BS	LRX 2GFP BC/SS	LRX 2GFP BC/BK	LRX 2GFP BC/N
3 Gang Grid Fix Aperture Plate	150.4 x 91.4	5	LRX 3GFP AB/SB	LRX 3GFP AB/AB	LRX 3GFP BC/PB	LRX 3GFP BC/BS	LRX 3GFP BC/SS	LRX 3GFP BC/BK	LRX 3GFP BC/N
4 Gang Grid Fix Aperture Plate	150.4 x 91.4	5	LRX 4GFP AB/SB	LRX 4GFP AB/AB	LRX 4GFP BC/PB	LRX 4GFP BC/BS	LRX 4GFP BC/SS	LRX 4GFP BC/BK	LRX 4GFP BC/N
	Nominal Size mm	Pack Qty.	Satin Nickel Frame/ Bright Steel Plate	Satin Nickel Frame/ Satin Steel Plate	Black Nickel Frame/ Polished Brass Plate	Black Nickel Frame/ Bright Steel Plate	Black Nickel Frame/ Black Nickel Plate		
1 Gang Grid Fix Frame and Plate	91.4 x 91.4	5	LRX 1GFP SN/BS	LRX 1GFP SN/SS	LRX 1GFP BK/PB	LRX 1GFP BK/BS	LRX 1GFP BK/BK		
2 Gang Grid Fix Aperture Plate	91.4 x 91.4	5	LRX 2GFP SN/BS	LRX 2GFP SN/SS	LRX 2GFP BK/PB	LRX 2GFP BK/BS	LRX 2GFP BK/BK		
3 Gang Grid Fix Aperture Plate	150.4 x 91.4	5	LRX 3GFP SN/BS	LRX 3GFP SN/SS	LRX 3GFP BK/PB	LRX 3GFP BK/BS	LRX 3GFP BK/BK		
4 Gang Grid Fix Aperture Plate	150.4 x 91.4	5	LRX 4GFP SN/BS	LRX 4GFP SN/SS	LRX 4GFP BK/PB	LRX 4GFP BK/BS	LRX 4GFP BK/BK		

**Linea-Scala CFX® Grid Fix Frames and Plates**

	Nominal Size mm	Pack Qty.	Polished Brass Frame/ Polished Brass Plate	Polished Brass Frame/ Satin Brass Plate	Polished Brass Frame/ Antique Brass Plate	Polished Brass Frame/ Bright Steel Plate	Polished Brass Frame/ Satin Steel Plate	Satin Brass Frame/ Satin Brass Plate	Satin Brass Frame/ Satin Steel Plate
1 Gang Grid Fix Frame and Plate	91.4 x 91.4	5	LSX 1GFP PB/PB	LSX 1GFP PB/SB	LSX 1GFP PB/AB	LSX 1GFP PB/BS	LSX 1GFP PB/SS	LSX 1GFP SB/SB	LSX 1GFP SB/SS
2 Gang Grid Fix Aperture Plate	91.4 x 91.4	5	LSX 2GFP PB/PB	LSX 2GFP PB/SB	LSX 2GFP PB/AB	LSX 2GFP PB/BS	LSX 2GFP PB/SS	LSX 2GFP SB/SB	LSX 2GFP SB/SS
3 Gang Grid Fix Aperture Plate	150.4 x 91.4	5	LSX 3GFP PB/PB	LSX 3GFP PB/SB	LSX 3GFP PB/AB	LSX 3GFP PB/BS	LSX 3GFP PB/SS	LSX 3GFP SB/SB	LSX 3GFP SB/SS
4 Gang Grid Fix Aperture Plate	150.4 x 91.4	5	LSX 4GFP PB/PB	LSX 4GFP PB/SB	LSX 4GFP PB/AB	LSX 4GFP PB/BS	LSX 4GFP PB/SS	LSX 4GFP SB/SB	LSX 4GFP SB/SS
	Nominal Size mm	Pack Qty.	Antique Brass Frame/ Satin Brass Plate	Antique Brass Frame/ Antique Brass Plate	Bright Chrome Frame/ Polished Brass Plate	Bright Chrome Frame/ Bright Steel Plate	Bright Chrome Frame/ Satin Steel Plate	Bright Chrome Frame/ Black Nickel Plate	
1 Gang Grid Fix Frame and Plate	91.4 x 91.4	5	LSX 1GFP AB/SB	LSX 1GFP AB/AB	LSX 1GFP BC/PB	LSX 1GFP BC/BS	LSX 1GFP BC/SS	LSX 1GFP BC/BK	
2 Gang Grid Fix Aperture Plate	91.4 x 91.4	5	LSX 2GFP AB/SB	LSX 2GFP AB/AB	LSX 2GFP BC/PB	LSX 2GFP BC/BS	LSX 2GFP BC/SS	LSX 2GFP BC/BK	
3 Gang Grid Fix Aperture Plate	150.4 x 91.4	5	LSX 3GFP AB/SB	LSX 3GFP AB/AB	LSX 3GFP BC/PB	LSX 3GFP BC/BS	LSX 3GFP BC/SS	LSX 3GFP BC/BK	
4 Gang Grid Fix Aperture Plate	150.4 x 91.4	5	LSX 4GFP AB/SB	LSX 4GFP AB/AB	LSX 4GFP BC/PB	LSX 4GFP BC/BS	LSX 4GFP BC/SS	LSX 4GFP BC/BK	
	Nominal Size mm	Pack Qty.	Satin Nickel Frame/ Bright Steel Plate	Satin Nickel Frame/ Satin Steel Plate	Black Nickel Frame/ Polished Brass Plate	Black Nickel Frame/ Bright Steel Plate	Black Nickel Frame/ Black Nickel Plate		
1 Gang Grid Fix Frame and Plate	91.4 x 91.4	5	LSX 1GFP SN/BS	LSX 1GFP SN/SS	LSX 1GFP BK/PB	LSX 1GFP BK/BS	LSX 1GFP BK/BK		
2 Gang Grid Fix Aperture Plate	91.4 x 91.4	5	LSX 2GFP SN/BS	LSX 2GFP SN/SS	LSX 2GFP BK/PB	LSX 2GFP BK/BS	LSX 2GFP BK/BK		
3 Gang Grid Fix Aperture Plate	150.4 x 91.4	5	LSX 3GFP SN/BS	LSX 3GFP SN/SS	LSX 3GFP BK/PB	LSX 3GFP BK/BS	LSX 3GFP BK/BK		
4 Gang Grid Fix Aperture Plate	150.4 x 91.4	5	LSX 4GFP SN/BS	LSX 4GFP SN/SS	LSX 4GFP BK/PB	LSX 4GFP BK/BS	LSX 4GFP BK/BK		

## Linea-CFX® Finishes

This chart illustrates the various combination of Frame and Plate finishes available in the Linea-Rondo CFX, Linea-Scala CFX and Linea-Duo CFX Ranges.

Note: Piano Black is only available in Linea-Rondo CFX.

	Polished Brass Plate	Satin Brass Plate	Antique Brass Plate	Bright Steel Plate	Satin Steel Plate	Black Nickel Plate	Piano Black Plate
Polished Brass Frame	PB/PB	PB/SB	PB/AB	PB/BS	PB/SS		
Satin Brass Frame		SB/SB			SB/SS		
Antique Brass Frame		AB/SB	AB/AB				
Bright Chrome Frame	BC/PB			BC/BS	BC/SS	BC/BK	BC/N
Satin Nickel Frame				SN/BS	SN/SS		
Black Nickel Frame	BK/PB			BK/BS		BK/BK	

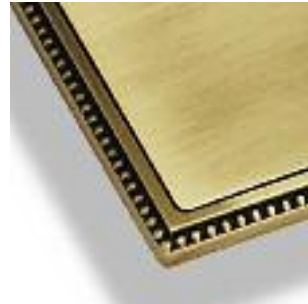

Linea-Perlina CFX®



Linea-Georgian CFX®

This chart illustrates the various combinations of Frame and Plate finishes available in the Linea-Perlina CFX and Linea-Georgian CFX Ranges.

	Polished Brass Plate	Satin Brass Plate	Antique Brass Plate
Polished Brass Frame	PB/PB	PB/SB	PB/AB
Antique Brass Frame	AB/PB	AB/SB	AB/AB

## Linea-Duo CFX® Grid Fix Frames and Plates

	Nominal Size mm	Pack Qty.	Polished Brass Frame/ Polished Brass Plate	Polished Brass Frame/ Satin Brass Plate	Polished Brass Frame/ Antique Brass Plate	Polished Brass Frame/ Bright Steel Plate	Polished Brass Frame/ Satin Steel Plate	Satin Brass Frame/ Satin Brass Plate	Satin Brass Frame/ Satin Steel Plate
1 Gang Grid Fix Frame and Plate	86 x 86	5	LD 1GFP PB/PB	LD 1GFP PB/SB	LD 1GFP PB/AB	LD 1GFP PB/BS	LD 1GFP PB/SS	LD 1GFP SB/SB	LD 1GFP SB/SS
2 Gang Grid Fix Aperture Plate	86 x 86	5	LD 2GFP PB/PB	LD 2GFP PB/SB	LD 2GFP PB/AB	LD 2GFP PB/BS	LD 2GFP PB/SS	LD 2GFP SB/SB	LD 2GFP SB/SS
3 Gang Grid Fix Aperture Plate	145 x 86	5	LD 3GFP PB/PB	LD 3GFP PB/SB	LD 3GFP PB/AB	LD 3GFP PB/BS	LD 3GFP PB/SS	LD 3GFP SB/SB	LD 3GFP SB/SS
4 Gang Grid Fix Aperture Plate	145 x 86	5	LD 4GFP PB/PB	LD 4GFP PB/SB	LD 4GFP PB/AB	LD 4GFP PB/BS	LD 4GFP PB/SS	LD 4GFP SB/SB	LD 4GFP SB/SS

	Nominal Size mm	Pack Qty.	Antique Brass Frame/ Satin Brass Plate	Antique Brass Frame/ Antique Brass Plate	Bright Chrome Frame/ Polished Brass Plate	Bright Chrome Frame/ Bright Steel Plate	Bright Chrome Frame/ Satin Steel Plate	Bright Chrome Frame/ Black Nickel Plate
1 Gang Grid Fix Frame and Plate	86 x 86	5	LD 1GFP AB/SB	LD 1GFP AB/AB	LD 1GFP BC/PB	LD 1GFP BC/BS	LD 1GFP BC/SS	LD 1GFP BC/BK
2 Gang Grid Fix Aperture Plate	86 x 86	5	LD 2GFP AB/SB	LD 2GFP AB/AB	LD 2GFP BC/PB	LD 2GFP BC/BS	LD 2GFP BC/SS	LD 2GFP BC/BK
3 Gang Grid Fix Aperture Plate	145 x 86	5	LD 3GFP AB/SB	LD 3GFP AB/AB	LD 3GFP BC/PB	LD 3GFP BC/BS	LD 3GFP BC/SS	LD 3GFP BC/BK
4 Gang Grid Fix Aperture Plate	145 x 86	5	LD 4GFP AB/SB	LD 4GFP AB/AB	LD 4GFP BC/PB	LD 4GFP BC/BS	LD 4GFP BC/SS	LD 4GFP BC/BK

	Nominal Size mm	Pack Qty.	Satin Nickel Frame/ Bright Steel Plate	Satin Nickel Frame/ Satin Steel Plate	Black Nickel Frame/ Polished Brass Plate	Black Nickel Frame/ Bright Steel Plate	Black Nickel Frame/ Black Nickel Plate
1 Gang Grid Fix Frame and Plate	86 x 86	5	LD 1GFP SN/BS	LD 1GFP SN/SS	LD 1GFP BK/PB	LD 1GFP BK/BS	LD 1GFP BK/BK
2 Gang Grid Fix Aperture Plate	86 x 86	5	LD 2GFP SN/BS	LD 2GFP SN/SS	LD 2GFP BK/PB	LD 2GFP BK/BS	LD 2GFP BK/BK
3 Gang Grid Fix Aperture Plate	145 x 86	5	LD 3GFP SN/BS	LD 3GFP SN/SS	LD 3GFP BK/PB	LD 3GFP BK/BS	LD 3GFP BK/BK
4 Gang Grid Fix Aperture Plate	145 x 86	5	LD 4GFP SN/BS	LD 4GFP SN/SS	LD 4GFP BK/PB	LD 4GFP BK/BS	LD 4GFP BK/BK

## Linea-Perlina CFX® Grid Fix Frames and Plates

	Nominal Size mm	Pack Qty.	Polished Brass Frame/ Polished Brass Plate	Polished Brass Frame/ Satin Brass Plate	Polished Brass Frame/ Antique Brass Plate	Antique Brass Frame/ Polished Brass Plate	Antique Brass Frame/ Satin Brass Plate	Antique Brass Frame/ Antique Brass Plate
1 Gang Grid Fix Frame and Plate	91.4 x 91.4	5	LPX 1GFP PB/PB	LPX 1GFP PB/SB	LPX 1GFP PB/AB	LPX 1GFP AB/PB	LPX 1GFP AB/SB	LPX 1GFP AB/AB
2 Gang Grid Fix Aperture Plate	91.4 x 91.4	5	LPX 2GFP PB/PB	LPX 2GFP PB/SB	LPX 2GFP PB/AB	LPX 2GFP AB/PB	LPX 2GFP AB/SB	LPX 2GFP AB/AB
3 Gang Grid Fix Aperture Plate	150.4 x 91.4	5	LPX 3GFP PB/PB	LPX 3GFP PB/SB	LPX 3GFP PB/AB	LPX 3GFP AB/PB	LPX 3GFP AB/SB	LPX 3GFP AB/AB
4 Gang Grid Fix Aperture Plate	150.4 x 91.4	5	LPX 4GFP PB/PB	LPX 4GFP PB/SB	LPX 4GFP PB/AB	LPX 4GFP AB/PB	LPX 4GFP AB/SB	LPX 4GFP AB/AB

## Linea-Georgian CFX® Grid Fix Frames and Plates

	Nominal Size mm	Pack Qty.	Polished Brass Frame/ Polished Brass Plate	Polished Brass Frame/ Satin Brass Plate	Polished Brass Frame/ Antique Brass Plate	Antique Brass Frame/ Polished Brass Plate	Antique Brass Frame/ Satin Brass Plate	Antique Brass Frame/ Antique Brass Plate
1 Gang Grid Fix Frame and Plate	95.5 x 95.5	5	LGX 1GFP PB/PB	LGX 1GFP PB/SB	LGX 1GFP PB/AB	LGX 1GFP AB/PB	LGX 1GFP AB/SB	LGX 1GFP AB/AB
2 Gang Grid Fix Aperture Plate	95.5 x 95.5	5	LGX 2GFP PB/PB	LGX 2GFP PB/SB	LGX 2GFP PB/AB	LGX 2GFP AB/PB	LGX 2GFP AB/SB	LGX 2GFP AB/AB
3 Gang Grid Fix Aperture Plate	154.5 x 95.5	5	LGX 3GFP PB/PB	LGX 3GFP PB/SB	LGX 3GFP PB/AB	LGX 3GFP AB/PB	LGX 3GFP AB/SB	LGX 3GFP AB/AB
4 Gang Grid Fix Aperture Plate	154.5 x 95.5	5	LGX 4GFP PB/PB	LGX 4GFP PB/SB	LGX 4GFP PB/AB	LGX 4GFP AB/PB	LGX 4GFP AB/SB	LGX 4GFP AB/AB

**Hamilton Sheer® Grid Fix**

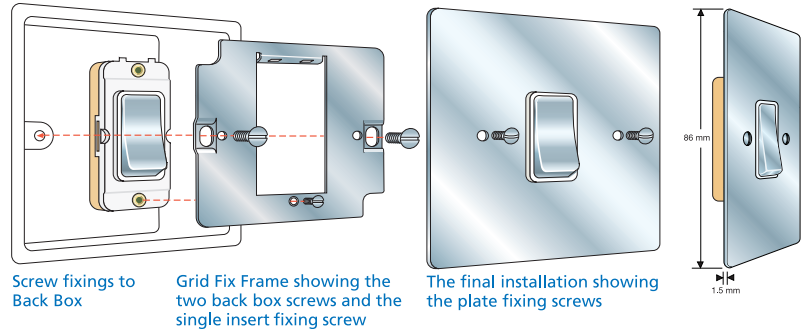

**Grid Fix Aperture Plates**  
complete with Fixing Grids and Plate Screws

	Nominal Size	Pack Qty.	Gloss White	Polished Brass	Satin Brass	Bright Chrome	Satin Chrome	Bright Stainless	Satin Stainless	Black Nickel	Pearl Oyster	Antique Brass
1 Gang Grid Fix Aperture Plate	86 x 86 mm	5	80 1GFP	81 1GFP	82 1GFP	87 1GFP	86 1GFP	83 1GFP	L84 1GFP	88 1GFP	8P 1GFP	89 1GFP
2 Gang Grid Fix Aperture Plate	86 x 86 mm	5	80 2GFP	81 2GFP	82 2GFP	87 2GFP	86 2GFP	83 2GFP	L84 2GFP	88 2GFP	8P 2GFP	89 2GFP
3 Gang Grid Fix Aperture Plate	146 x 86 mm	5	80 3GFP	81 3GFP	82 3GFP	87 3GFP	86 3GFP	83 3GFP	L84 3GFP	88 3GFP	8P 3GFP	89 3GFP
4 Gang Grid Fix Aperture Plate	146 x 86 mm	5	80 4GFP	81 4GFP	82 4GFP	87 4GFP	86 4GFP	83 4GFP	L84 4GFP	88 4GFP	8P 4GFP	89 4GFP
6 Gang Grid Fix Aperture Plate	146 x 146 mm	1	80 6GFP	81 6GFP	82 6GFP	87 6GFP	86 6GFP	83 6GFP	L84 6GFP	88 6GFP	8P 6GFP	89 6GFP
8 Gang Grid Fix Aperture Plate	146 x 146 mm	1	80 8GFP	81 8GFP	82 8GFP	87 8GFP	86 8GFP	83 8GFP	L84 8GFP	88 8GFP	8P 8GFP	89 8GFP
9 Gang Grid Fix Aperture Plate	146 x 210 mm	1	80 9GFP	81 9GFP	82 9GFP	87 9GFP	86 9GFP	83 9GFP	L84 9GFP	88 9GFP	8P 9GFP	89 9GFP
12 Gang Grid Fix Aperture Plate	146 x 210 mm	1	80 12GFP	81 12GFP	82 12GFP	87 12GFP	86 12GFP	83 12GFP	L84 12GFP	88 12GFP	8P 12GFP	89 12GFP

**13A Switched Socket Aperture Plates**

	Nominal Size	Pack Qty.	Gloss White	Polished Brass	Satin Brass	Bright Chrome	Satin Chrome	Bright Stainless	Satin Stainless	Black Nickel	Pearl Oyster	Antique Brass
1g 13A Switched Socket Grid Fix Aperture Plate	86 x 86 mm	5	80 SS1GFP	81 SS1GFP	82 SS1GFP	87 SS1GFP	86 SS1GFP	83 SS1GFP	L84 SS1GFP	88 SS1GFP	8P SS1GFP	89 SS1GFP
2g 13A Switched Socket Grid Fix Aperture Plate	146 x 86 mm	5	80 SS2GFP	81 SS2GFP	82 SS2GFP	87 SS2GFP	86 SS2GFP	83 SS2GFP	L84 SS2GFP	88 SS2GFP	8P SS2GFP	89 SS2GFP



1 gang Sheer Front Plate  
(Plate Illustrated 80 1GFP)



2 gang Sheer Front Plate  
(Plate Illustrated 89 2GFP)



3 gang Sheer Front Plate  
(Plate Illustrated 81 3GFP)



4 gang Sheer Front Plate  
(Plate Illustrated 87 4GFP)



6 gang Sheer Front Plate  
(Plate Illustrated 88 6GFP)



8 gang Sheer Front Plate  
(Plate Illustrated 8P 8GFP)



9 gang Sheer Front Plate  
(Plate Illustrated 82 9GFP)

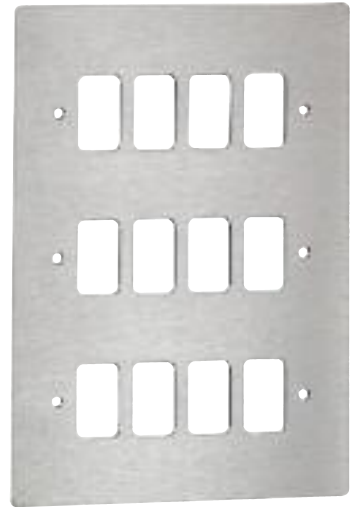

12 gang Sheer Front Plate  
(Plate Illustrated L84 12GFP)



1 gang Sheer Switched Socket Front Plate  
(Plate Illustrated 83 SS1GFP)



2 gang Sheer Switched Socket Front Plate  
(Plate Illustrated 86 SS2GFP)

# Hamilton GRID-IT SheerCFX® Concealed Fixing

## Hamilton Sheer CFX® Grid Fix Concealed Fixing

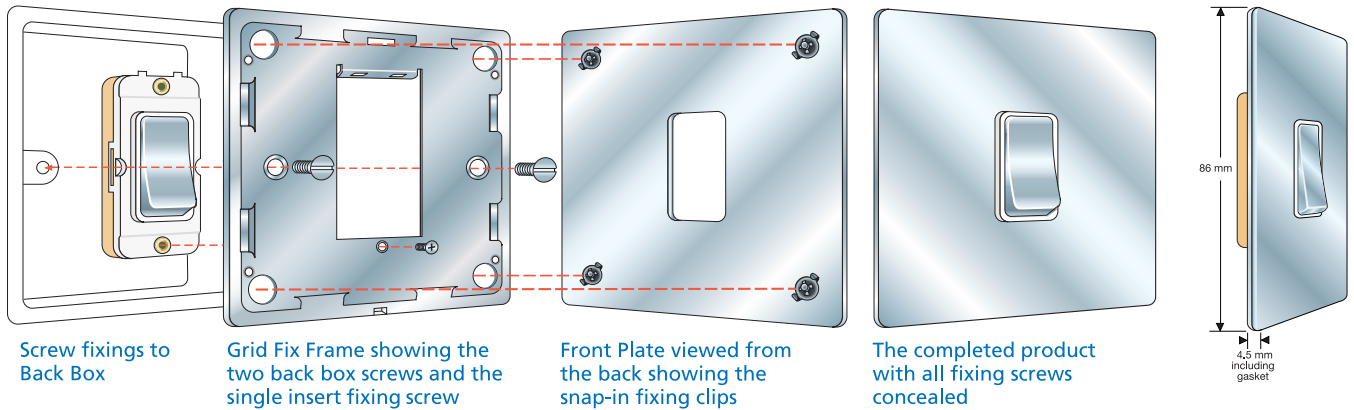

### Sheer CFX Concealed Fixing Aperture Plates complete with Grids and Plate Screws

	Nominal Size	Pack Qty.	Polished Brass	Satin Brass	Bright Chrome	Satin Stainless Finish	Black Nickel	Antique Brass
1 Gang Grid Fix Aperture Plate	86 x 86 mm	5	81C 1GFP	82C 1GFP	87C 1GFP	84C 1GFP	88C 1GFP	89C 1GFP
2 Gang Grid Fix Aperture Plate	86 x 86 mm	5	81C 2GFP	82C 2GFP	87C 2GFP	84C 2GFP	88C 2GFP	89C 2GFP
3 Gang Grid Fix Aperture Plate	145 x 86 mm	5	81C 3GFP	82C 3GFP	87C 3GFP	84C 3GFP	88C 3GFP	89C 3GFP
4 Gang Grid Fix Aperture Plate	145 x 86 mm	5	81C 4GFP	82C 4GFP	87C 4GFP	84C 4GFP	88C 4GFP	89C 4GFP



1 gang Sheer CFX Front Plate  
(Plate Illustrated 84C 1GFP)



2 gang Sheer CFX Front Plate  
(Plate Illustrated 87C 2GFP)

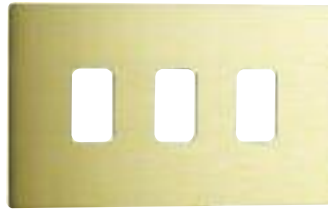

3 gang Sheer CFX Front Plate  
(Plate Illustrated 82C 3GFP)

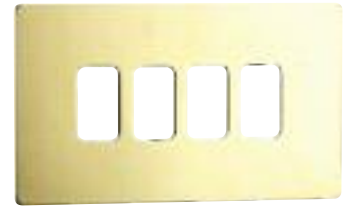

4 gang Sheer CFX Front Plate  
(Plate Illustrated 81C 4GFP)

### Sheer CFX Concealed Fixing Spare Grids complete with gasket

	Nominal Size	Pack Qty.	Order Code
1 Gang Grid with Gasket	86 x 86 mm	5	8C1G
2 Gang Grid with Gasket	86 x 86 mm	5	8C2G
3 Gang Grid with Gasket	145 x 86 mm	5	8C3G
4 Gang Grid with Gasket	145 x 86 mm	5	8C4G

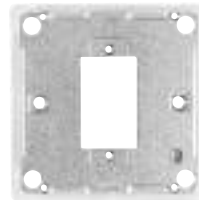

8C1G



8C2G

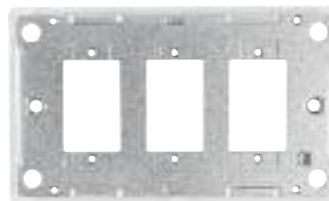

8C3G

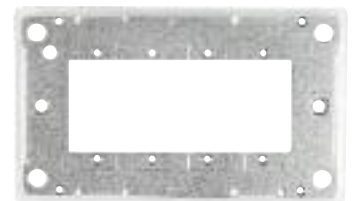

8C4G

Designed to fit Folded Metal Wall Box Enclosures that comply with BS 4662:1970.

# Hamilton® GRID-IT® Hartland®

**Grid Fix Aperture Plates**  
complete with Fixing Grids and Plate Screws

## Hamilton Hartland® Grid Fix

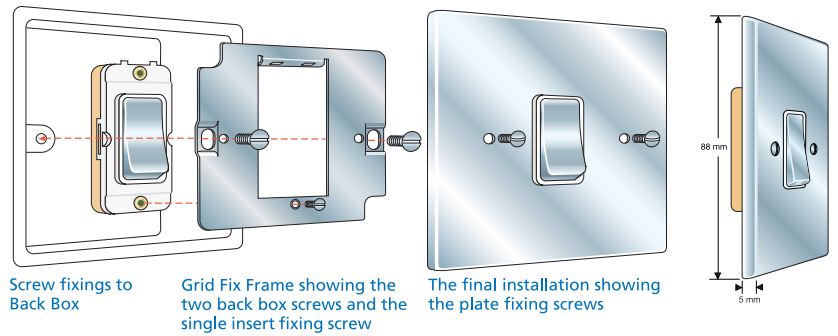

	Nominal Size	Pack Qty.	Gloss White	Polished Brass	Satin Brass	Bright Chrome	Satin Chrome	Bright Stainless	Satin Stainless	Black Nickel	Pearl Oyster	Antique Brass
1 Gang Grid Fix Aperture Plate	88 x 88 mm	5	70 1GFP	71 1GFP	72 1GFP	77 1GFP	76 1GFP	73 1GFP	L74 1GFP	78 1GFP	7P 1GFP	79 1GFP
2 Gang Grid Fix Aperture Plate	88 x 88 mm	5	70 2GFP	71 2GFP	72 2GFP	77 2GFP	76 2GFP	73 2GFP	L74 2GFP	78 2GFP	7P 2GFP	79 2GFP
3 Gang Grid Fix Aperture Plate	144 x 85 mm	5	70 3GFP	71 3GFP	72 3GFP	77 3GFP	76 3GFP	73 3GFP	L74 3GFP	78 3GFP	7P 3GFP	79 3GFP
4 Gang Grid Fix Aperture Plate	144 x 85 mm	5	70 4GFP	71 4GFP	72 4GFP	77 4GFP	76 4GFP	73 4GFP	L74 4GFP	78 4GFP	7P 4GFP	79 4GFP
6 Gang Grid Fix Aperture Plate	146 x 146 mm	1	70 6GFP	71 6GFP	72 6GFP	77 6GFP	76 6GFP	73 6GFP	L74 6GFP	78 6GFP	7P 6GFP	79 6GFP
8 Gang Grid Fix Aperture Plate	146 x 146 mm	1	70 8GFP	71 8GFP	72 8GFP	77 8GFP	76 8GFP	73 8GFP	L74 8GFP	78 8GFP	7P 8GFP	79 8GFP
9 Gang Grid Fix Aperture Plate	146 x 210 mm	1	70 9GFP	71 9GFP	72 9GFP	77 9GFP	76 9GFP	73 9GFP	L74 9GFP	78 9GFP	7P 9GFP	79 9GFP
12 Gang Grid Fix Aperture Plate	146 x 210 mm	1	70 12GFP	71 12GFP	72 12GFP	77 12GFP	76 12GFP	73 12GFP	L74 12GFP	78 12GFP	7P 12GFP	79 12GFP

## 13A Switched Socket Aperture Plates

	Nominal Size	Pack Qty.	Gloss White	Polished Brass	Satin Brass	Bright Chrome	Satin Chrome	Bright Stainless	Satin Stainless	Black Nickel	Pearl Oyster	Antique Brass
1g 13A Switched Socket Grid Fix Aperture Plate	88 x 88 mm	5	70 SS1GFP	71 SS1GFP	72 SS1GFP	77 SS1GFP	76 SS1GFP	73 SS1GFP	L74 SS1GFP	78 SS1GFP	7P SS1GFP	79 SS1GFP
2g 13A Switched Socket Grid Fix Aperture Plate	144 x 85 mm	5	70 SS2GFP	71 SS2GFP	72 SS2GFP	77 SS2GFP	76 SS2GFP	73 SS2GFP	L74 SS2GFP	78 SS2GFP	7P SS2GFP	79 SS2GFP



1 gang Hartland Front Plate  
(Plate Illustrated 71 1GFP)



2 gang Hartland Front Plate  
(Plate Illustrated 78 2GFP)

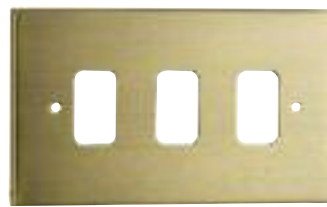

3 gang Hartland Front Plate  
(Plate Illustrated 79 3GFP)

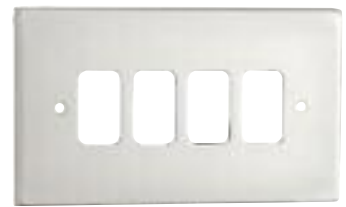

4 gang Hartland Front Plate  
(Plate Illustrated 7P 4GFP)



6 gang Hartland Front Plate  
(Plate Illustrated 73 6GFP)



8 gang Hartland Front Plate  
(Plate Illustrated L74 8GFP)



9 gang Hartland Front Plate  
(Plate Illustrated 72 9GFP)



12 gang Hartland Front Plate  
(Plate Illustrated 79 12GFP)



1 gang Hartland Switched Socket Front Plate  
(Plate Illustrated 77 SS1GFP)



2 gang Hartland Switched Socket Front Plate  
(Plate Illustrated 76 SS2GFP)

# Hamilton® GRID-IT Hartland CFX® Concealed Fixing

## Hamilton Hartland CFX® Grid Fix Concealed Fixing

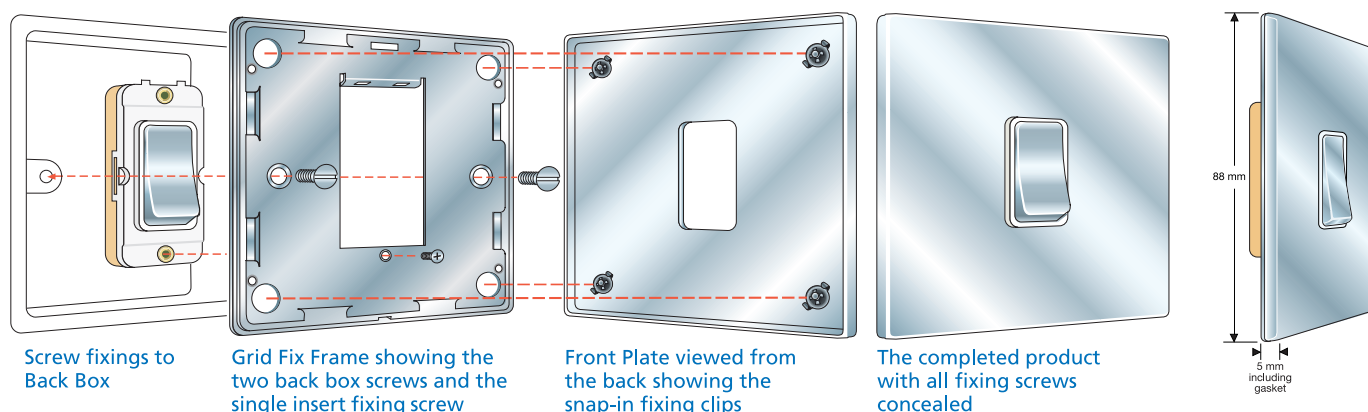

## Hartland CFX Concealed Fixing Aperture Plates complete with Grids and Plate Screws

	Nominal Size	Pack Qty.	Polished Brass	Satin Brass	Bright Chrome	Satin Stainless Finish	Black Nickel	Antique Brass
1 Gang Grid Fix Aperture Plate	86 x 86 mm	5	71C 1GFP	72C 1GFP	77C 1GFP	74C 1GFP	78C 1GFP	79C 1GFP
2 Gang Grid Fix Aperture Plate	86 x 86 mm	5	71C 2GFP	72C 2GFP	77C 2GFP	74C 2GFP	78C 2GFP	79C 2GFP
3 Gang Grid Fix Aperture Plate	145 x 86 mm	5	71C 3GFP	72C 3GFP	77C 3GFP	74C 3GFP	78C 3GFP	79C 3GFP
4 Gang Grid Fix Aperture Plate	145 x 86 mm	5	71C 4GFP	72C 4GFP	77C 4GFP	74C 4GFP	78C 4GFP	79C 4GFP



1 gang Hartland CFX Front Plate  
(Plate Illustrated 77C 1GFP)



2 gang Hartland CFX Front Plate  
(Plate Illustrated 72C 2GFP)



3 gang Hartland CFX Front Plate  
(Plate Illustrated 74C 3GFP)

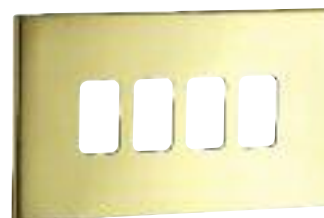

4 gang Hartland CFX Front Plate  
(Plate Illustrated 71C 4GFP)

## Hartland CFX Concealed Fixing Spare Grids complete with gasket

	Nominal Size	Pack Qty.	Order Code
1 Gang Grid with Gasket	88 x 88 mm	5	7C1G
2 Gang Grid with Gasket	88 x 88 mm	5	7C2G
3 Gang Grid with Gasket	144 x 85 mm	5	7C3G
4 Gang Grid with Gasket	144 x 85 mm	5	7C4G



7C1G



7C2G

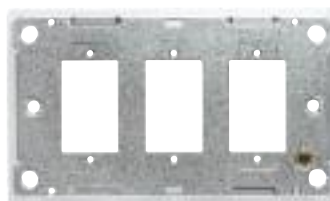

7C3G



7C4G

Designed to fit Folded Metal Wall Box Enclosures that comply with BS 4662:1970.

# Hamilton® GRID-IT® CHERITON®

## Grid Fix Aperture Plates complete with Fixing Grids and Plate Screws

### Hamilton Cheriton® Grid Fix

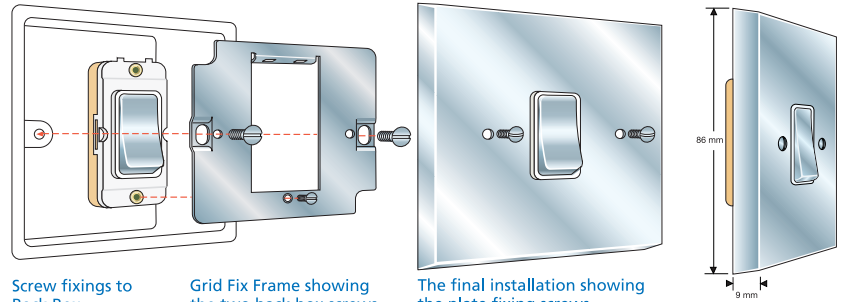

Screw fixings to Back Box

Grid Fix Frame showing the two back box screws and the single grid fix screw

The final installation showing the plate fixing screws

	Nominal Size	Pack Qty.	Georgian Polished Brass	Victorian Polished Brass	Victorian Satin Brass	Victorian Bright Chrome	Victorian Satin Chrome
1 Gang Grid Fix Aperture Plate	88 x 88 mm	5	90 1GFP	92 1GFP	94 1GFP	95 1GFP	96 1GFP
2 Gang Grid Fix Aperture Plate	88 x 88 mm	5	90 2GFP	92 2GFP	94 2GFP	95 2GFP	96 2GFP
3 Gang Grid Fix Aperture Plate	146 x 86 mm	5	90 3GFP	92 3GFP	94 3GFP	95 3GFP	96 3GFP
4 Gang Grid Fix Aperture Plate	146 x 86 mm	5	90 4GFP	92 4GFP	94 4GFP	95 4GFP	96 4GFP
6 Gang Grid Fix Aperture Plate	150 x 150 mm	1	90 6GFP	92 6GFP	94 6GFP	95 6GFP	96 6GFP
8 Gang Grid Fix Aperture Plate	150 x 150 mm	1	90 8GFP	92 8GFP	94 8GFP	95 8GFP	96 8GFP
9 Gang Grid Fix Aperture Plate	150 x 210 mm	1	90 9GFP	92 9GFP	94 9GFP	95 9GFP	96 9GFP
12 Gang Grid Fix Aperture Plate	150 x 210 mm	1	90 12GFP	92 12GFP	94 12GFP	95 12GFP	96 12GFP

### 13A Switched Socket Aperture Plates

	Nominal Size	Pack Qty.	Georgian Polished Brass	Victorian Polished Brass	Victorian Satin Brass	Victorian Bright Chrome	Victorian Satin Chrome
1g 13A Switched Socket Aperture Plate	86 x 86 mm	5	90 SS1GFP	92 SS1GFP	94 SS1GFP	95 SS1GFP	96 SS1GFP
2g 13A Switched Socket Aperture Plate	146 x 86 mm	5	90 SS2GFP	92 SS2GFP	94 SS2GFP	95 SS2GFP	96 SS2GFP



1 gang Cheriton Front Plate  
(Plate Illustrated 94 1GFP)



2 gang Cheriton Front Plate  
(Plate Illustrated 96 2GFP)

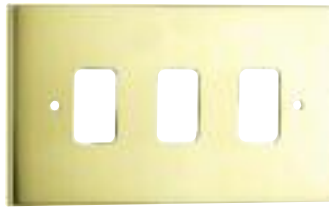

3 gang Cheriton Front Plate  
(Plate Illustrated 92 3GFP)

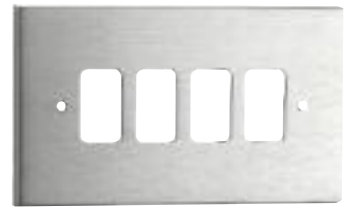

4 gang Cheriton Front Plate  
(Plate Illustrated 96 4GFP)



6 gang Cheriton Front Plate  
(Plate Illustrated 95 6GFP)



8 gang Cheriton Front Plate  
(Plate Illustrated 90 8GFP)



9 gang Cheriton Front Plate  
(Plate Illustrated 95 9GFP)



12 gang Cheriton Front Plate  
(Plate Illustrated 92 12GFP)



1 gang Cheriton Switched Socket Front Plate  
(Plate Illustrated 94 SS1GFP)



2 gang Cheriton Switched Socket Front Plate  
(Plate Illustrated 90 SS2GFP)

Module Type including Key Switches	2 Way 20AX (R21/20 K21/20)	Intermediate 20AX (R31/20)	Double Pole 20AX (20DP K20DP)	Push to Make/Break (PTM BP)	2 Way + Off 20AX Non Retractive (R2WO)	2 Way + Off 20AX Retractive (RR2W)	NEON	FUSE Supplied with Fuselink to BS 1362 Standard
Standards and Approvals	BS EN 60669-1 and IEC 669-1	BS EN 60669-1 and IEC 669-1	BS EN 60669-1 and IEC 669-1	BS EN 60669-1 and IEC 669-1	BS EN 60669-1 and IEC 669-1	BS EN 60669-1	BS5733	BS5733
Voltage	250V~	250V~	250V~	250V~	250V~	250V~	250V~	250V~
Current - No de-rating required when used for fluorescent or inductive loads	20AX	20AX	20AX	10AX	20AX	10AX	N/A	13A
Number of Poles	1	2	2	1	1	1	N/A	N/A
Contact Gap	<3mm	<3mm	<3mm	<3mm	<3mm	<3mm	N/A	N/A
Terminal Capacity per Module	5 x 1mm <sup>2</sup> 4 x 1.5mm <sup>2</sup> 3 x 2.5mm <sup>2</sup> 2 x 4mm <sup>2</sup> Multi-Strand 1 x 6mm <sup>2</sup>	5 x 1mm <sup>2</sup> 4 x 1.5mm <sup>2</sup> 3 x 2.5mm <sup>2</sup> 2 x 4mm <sup>2</sup> Multi-Strand 1 x 6mm <sup>2</sup>	5 x 1mm <sup>2</sup> 4 x 1.5mm <sup>2</sup> 3 x 2.5mm <sup>2</sup> 2 x 4mm <sup>2</sup> Multi-Strand 1 x 6mm <sup>2</sup>	5 x 1mm <sup>2</sup> 4 x 1.5mm <sup>2</sup> 3 x 2.5mm <sup>2</sup> 2 x 4mm <sup>2</sup> Multi-Strand 1 x 6mm <sup>2</sup>	5 x 1mm <sup>2</sup> 4 x 1.5mm <sup>2</sup> 3 x 2.5mm <sup>2</sup> 2 x 4mm <sup>2</sup> Multi-Strand 1 x 6mm <sup>2</sup>	5 x 1mm <sup>2</sup> 4 x 1.5mm <sup>2</sup> 3 x 2.5mm <sup>2</sup> 2 x 4mm <sup>2</sup> Multi-Strand 1 x 6mm <sup>2</sup>	5 x 1mm <sup>2</sup> 4 x 1.5mm <sup>2</sup> 3 x 2.5mm <sup>2</sup> 2 x 4mm <sup>2</sup> Multi-Strand 1 x 6mm <sup>2</sup>	5 x 1mm <sup>2</sup> 4 x 1.5mm <sup>2</sup> 3 x 2.5mm <sup>2</sup> 2 x 4mm <sup>2</sup> Multi-Strand 1 x 6mm <sup>2</sup>

Module Type	400W 2 Way Push On/Off Resistive Dimmer (D4002)	3A Intermediate Push On/Off (DIP)	6A 2 Way Push On/Off (D5102)	1-10V Push On/Off (DRTW)	1-10V DC Ballast Control No Off (DHF 10V)	Trailing Edge Touch Master Multi-Way 250VA Max. 25W/VA Min. On/Off - Up/Down (DT250M)	Touch Slave Controllers On/Off - Up/Down (DTS)	Trailing Edge Push On/Off 250VA Max. 25W/VA Min. (D250TR)
Standards and Approvals	BS EN 60669-2-1	BS 5733	BS EN 60669-1	N/A	BS EN 60669-1	BS EN 60669-2-1	BS EN 60669-2-1	BS EN 60669-2-1
Voltage	230V~	230V~	230V~	1-10V	1-10V DC	230V~	230V~	230V~
Current	1.25 amps	3A	6AX	N/A	N/A	1.1 amps per gang	N/A	1.1 amps per gang
Number of Poles	N/A	N/A	N/A	N/A	N/A	N/A	N/A	1
Contact Gap	N/A	N/A	N/A	N/A	N/A	N/A	N/A	N/A
Terminal Capacity per Module	2 x 1mm <sup>2</sup> 2 x 1.5mm <sup>2</sup>	2 x 1mm <sup>2</sup> 2 x 1.5mm <sup>2</sup>	2 x 1mm <sup>2</sup> 2 x 1.5mm <sup>2</sup>	1 x 1mm <sup>2</sup>	1 x 1mm <sup>2</sup>	2 x 1mm <sup>2</sup> 2 x 1.5mm <sup>2</sup>	2 x 1mm <sup>2</sup> 2 x 1.5mm <sup>2</sup>	2 x 1mm <sup>2</sup> 2 x 1.5mm <sup>2</sup>

Mains operated and Low Voltage modules must NOT be installed within the same front plate.

	GRIDS	Module Type	CABLE OUTLET
Earth Terminal Capacity	4 x 1.5mm <sup>2</sup> 3 x 2.5mm <sup>2</sup> 2 x 4mm <sup>2</sup> Multi-Strand 1 x 6mm <sup>2</sup>	Standards and Approvals	BS5733
		Voltage	250V~
		Current	20A
		Supply Terminal Capacity	5 x 1mm <sup>2</sup> 4 x 1.5mm <sup>2</sup> 3 x 2.5mm <sup>2</sup> 2 x 4mm <sup>2</sup> Multi-Strand
		Load Terminal Capacity	Min 0.75mm <sup>2</sup> Max 2.5mm <sup>2</sup>

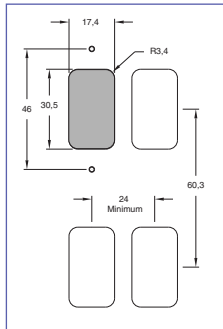
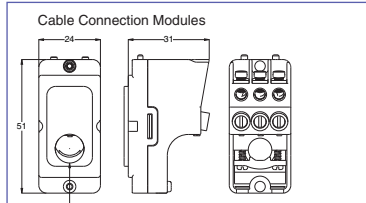
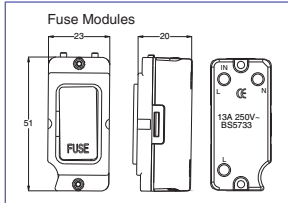
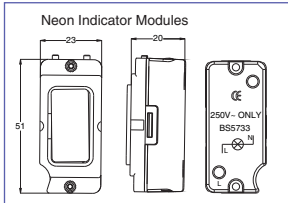
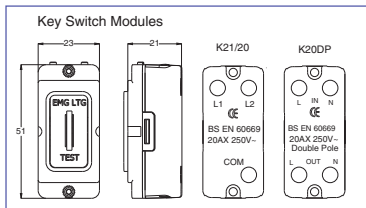
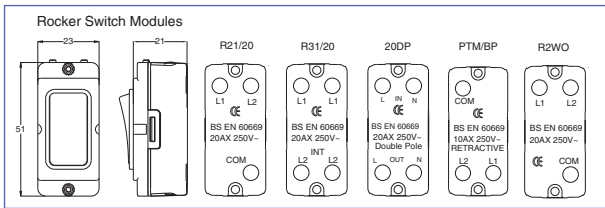

Module Type	SS1	SS2
Standards and Approvals	BS1363, MS589 and SS145	BS1363, MS589 and SS145
Voltage	250V~	250V~
Current per Outlet	13A	13A
Number of Poles	2	2
Contact Gap	<3mm	<3mm
Terminal Capacity per Module	4 x 2.5mm <sup>2</sup> 3 x 4mm <sup>2</sup> 2 x 6mm <sup>2</sup> Multi-Strand 1 x 10mm <sup>2</sup>	4 x 2.5mm <sup>2</sup> 3 x 4mm <sup>2</sup> 2 x 6mm <sup>2</sup> Multi-Strand 1 x 10mm <sup>2</sup>

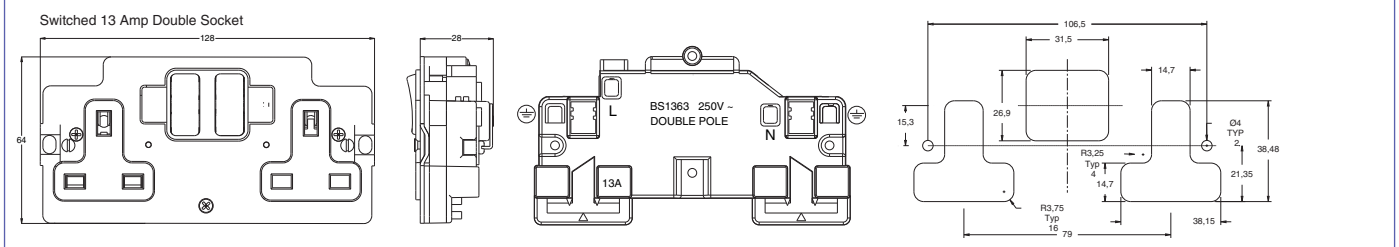
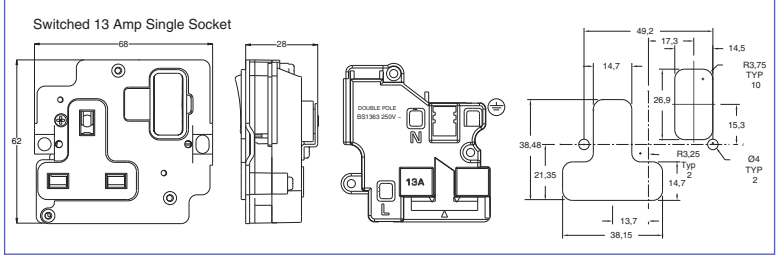

# Hamilton® GRID-IT

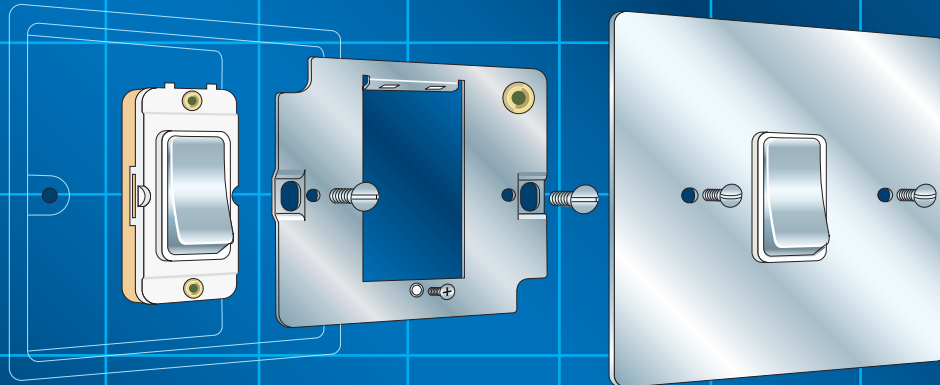

## Other products available from the Hamilton Group

- The Linea-CFX Collection
- Hartland CFX Concealed Fixing
- Sheer CFX Concealed Fixing
- Hartland Range (Box Fix)
- Sheer Range (Box Fix)
- Cheriton Range (Box Fix)
- Woods & Bloomsbury Range
- Digital Mercury Lighting Controls
- Data and Media Range (Data & Communication Outlets)
- IP Weatherproof Switches and Sockets
- Sheer Floor Sockets
- Hotel Card Switch

*All products listed conform to current British or European standards and the product information is correct at the time of going to press.*

*All accessories are manufactured under an accredited BS EN ISO 9001: 2000 Quality System. It is the policy of the company to continually improve products as part of our development programme. Therefore, we reserve the right to alter designs and dimensions without prior notice.*

*Illustrations and diagrams are reproduced within the limitations of reproduction and printing processes and are not binding.*

*Due to manufacturing processes we cannot guarantee an exact colour match and shadings of certain finishes.*

**Hamilton®**  
Litestat group

For further information please contact:

R. Hamilton & Co. Ltd., Quarry Industrial Estate, Mere, Wiltshire BA12 6LA, UK  
Telephone: +44 (0)1747 860088 Facsimile: +44 (0)1747 861032  
email: [info@hamilton-litestat.com](mailto:info@hamilton-litestat.com) [www.hamilton-litestat.com](http://www.hamilton-litestat.com)



BS EN ISO 9001:2000  
CERT NO. RM11238

