

**James Walker**<sup>®</sup>

## Walkersele<sup>®</sup> Radial Lip Seals

- ***High-efficiency lip seals for rotary duties***
- ***Proven long-term bearing protection***
- ***Many standard sizes ex-stock***
- ***Unlimited diameters to order***
- ***Custom-designed specials***
- ***Also V-ring and metal cased lip seals***



High Performance Sealing Technology



# Introduction

James Walker & Co is a member of the James Walker Group, a dynamic global manufacturing organisation that supplies a vast range of specialised products and services to virtually every industrial sector.

We have more than 50 production, engineering, distribution and customer support facilities worldwide — backed by extensive IT networks, e-commerce systems and logistics operations — to serve customers in over 100 countries.

Two of our world-leading areas of expertise are high performance fluid sealing and bolting technology. These are mainly materials-led, and range from research, development and manufacture to product application and plant refurbishment. Together with associated knowledge based services, they help to keep industry running safely and efficiently, year after year.

## Contents

### P3. **Why you fit Walkersele®**

#### **Walkersele® selection**

- P4. Simple steps to Walkersele selection
- P4. Performance table 1: Maximum working pressure
- P5. Performance table 2: Walkerseles for use with retaining plates
- P5. Performance table 3: Self-retaining Walkerseles

### P6. **Walkersele® profile & material combinations**

#### **Walkersele® standard materials**

- P7. M1 — nitrile (NBR)
- P7. M5 — butyl (IIR)
- P7. M6 — nitrile (NBR)
- P8. M8 — fluoroelastomer (FKM)
- P8. M9 — fluoroelastomer (FKM)
- P8. Elast-O-Lion® 180 & EOL/KC300 — hydrogenated nitrile (HNBR)
- P8. FR66/80 & FR66/KC300 — fluoroelastomer (FKM) for electrical insulation duties
- P8. Fluolion® (PTFE)

#### **Walkersele® high-performance materials**

- P9. Ultraglide — reformulated hydrogenated nitrile (HNBR)
- P9. Aflas® — tetrafluoroethylene/propylene (FEPM)

#### **Walkersele® designs**

- P10. Walkersele® D6 — our most popular design
- P11. Walkersele® D7 — pressure resistant lip seal
- P11. Walkersele® D1 — original design
- P12. Walkersele® D5 — compact design
- P12. Walkersele® D4 — slow rotary duties
- P12. Walkersele® TBMS — tunnel boring machine seal
- P13. Customised designs

### P14-15. **Walkersele® OSJ-2 for On-Site Joining**

#### **Special arrangements for worn shafts**

- P16. Walkersele® Cartridges
- P16. Spacer rings
- P16. Walkersele® Shaft Sleeves

#### **Special features**

- P17. Walkersele® SpringSafe
- P17. Walkersele® SpringCover
- P17. Walkersele® with Dust Lip
- P18. Walkersele® Shallowback designs
- P18. Walkersele® Long Lip
- P18. Walkersele® with ports & grooves
- P19. Endless-type Walkerseles
- P19. Split-type Walkerseles

#### **Standard ranges**

- P20. **Walkersele® M1/D6**
- P20. JW Chart 56: M1/D6 — inch sizes
- P21. JW Chart 57: M1/D6 — metric sizes
- P22. **Walkersele® M6/D6**
- P22. JW Chart 104: M6/D6 — inch sizes
- P23. JW Chart 105: M6/D6 — metric sizes
- P23/24. JW Chart 376: M6/D6 — to DIN3760/(BS) ISO 6194-1

#### **Walkersele® housings**

- P25. Housing sizes — Walkersele® D6 design
- P25. Housing sizes — Walkersele® D7 design
- P26. Housing tolerances — D6 & D7 designs
- P26. Housing chamfers — D6 & D7 designs
- P26. Shaft chamfers — D6 & D7 designs
- P26. Retaining plate dimensions — D6 & D7 designs

#### **Walkersele® installation techniques**

- P27. General information
- P27. Endless seals (except M6 & M8)
- P27. Endless seals M6 & M8 self-retaining
- P27. Split seals (not applicable to M6 & M8)
- P28. Fitting self-retaining lip seals in blind housing (closed recess)
- P28. Walkersele® OSJ-2 On-Site Joining

#### **Operational considerations**

- P29. Multi-seal configurations
- P29. Seal lubrication
- P30. Eccentricity limits
- P30. Lip support plates
- P30. Shaft surfaces
- P31. Shaft hardness
- P31. Ceramic shafts
- P31. Housing surfaces
- P31. Walkersele® storage
- P31. Walkersele® power consumption

#### **Other rotary seals**

- P32. End face seals or V-rings
- P32. Metal cased lip seals

#### **James Walker in action**

- P33. Customer support at every level
- P33. Worldwide network and supply
- P33. Production facilities
- P34. Quality standards
- P34. Research & development
- P35. Industry-wide applications
- P35. Trademark acknowledgements
- P35. General information
- P36. Contacts

## Why you fit Walkersele®

### Worldwide reputation

Walkersele® is our well proven family of radial lip seals for rotating shafts and rotary plant such as gearboxes, rolling mills, marine propulsion systems, process mixers and kilns.

Industry worldwide relies on Walkersele to:

- Protect bearings
- Prevent ingress of water and other media
- Keep lubricants contamination-free
- Prevent oil and grease spoiling finished products.

Moreover, design engineers and plant operators rely on our pedigree in high performance fluid sealing technology and full technical back-up to provide the *best value* solution to their specific sealing problems.

### Constant development & innovation

When our many standard designs cannot solve a particular problem, we can custom design and manufacture a special lip seal that will. We use state-of-the-art finite element analysis (FEA) techniques to fine tune the design parameters before prototyping and running the product on our in-house test rigs.

Constant research and development over the past 50 years has produced numerous improvements in materials and design. These ensure Walkersele® can operate efficiently for extended periods in hot and abrasive industrial environments and below the surface on marine vessels of every size.

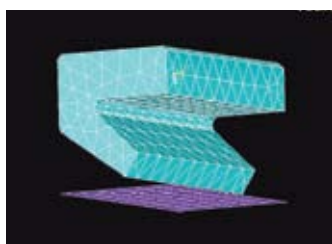

Special innovative features such as our patented Walkersele OSJ-2 on-site joining technique, SpringSafe positive spring retention system, and Cartridge Walkersele, all provide top level sealing integrity with peace-of-mind plus easier and swifter installation for reduced plant downtime.

### Better efficiency — lower running costs

The main job of Walkersele® is to retain lubricant within a bearing assembly. It will effectively

- Extend bearing life and improve plant reliability.
- Cut maintenance costs and downtime.
- Reduce lubricant loss and costs.
- Cut power consumption with low-friction running.
- Reduce corrosion caused by dissimilar metal interfaces.

When manufactured with a secondary lip a Walkersele will also prevent the ingress of solid or liquid contaminants. Back-to-back configurations within a housing are particularly effective at the interface of two separate fluids, such as oil and water.

### Flexible manufacturing & stockholding

We have over 7500 mould tools for Walkersele® production, for virtually all shafts of metric and inch standard sizes, plus hundreds of non-standards. The list grows constantly.

Large volumes of Walkersele in popular types and sizes are stocked for same day despatch. We also provide an express manufacturing service to meet industry's most urgent demands.



Our Materials Technology Centre houses one of Europe's largest elastomer moulding presses for making seals up to 2.2m OD (87 inch) in a single pass. But this does not limit the size of a Walkersele as we mould to unlimited diameters using a special technique — our current record stands at 11m (36 ft) diameter!

### Overcoming the Gough-Joule Effect

When an elastomer in tension is heated, the tension within the rubber increases — a phenomenon known as the Gough-Joule Effect. Thus, if an elastomeric radial seal in tension is subjected to frictional heat, it tightens on the shaft to generate higher friction, wear and more heat, reducing the seal's working life.

Standard M1, M5 and M9 Walkerseles overcome this effect by having an interference fit within the housing bore. This puts the elastomer into **compression**, rather than **tension**, to avoid the vicious cycle of frictional heat followed by increased tension and wear.

# Walkersele<sup>®</sup> selection

## Simple steps to Walkersele<sup>®</sup> selection

Walkersele<sup>®</sup> radial lip seals are identified by their **Materials** of construction (M1, Ultraglides K, etc) and **Design** (D6, D7, etc). Typical designations are **Walkersele M1/D7**, and **Walkersele Ultraglides K/D6**.

To select the correct Walkersele for your application, please consider your operational parameters in the order outlined below.

### Step 1: Maximum working pressure

Maximum working pressure is the primary parameter used to determine the most suitable **Walkersele Design** for your application. Please refer to **Performance Table 1**, below.

PERFORMANCE TABLE 1	
Maximum working pressure	Walkersele <sup>®</sup> Design recommendations
≤0.2bar (2.9psi)	D6 & D6/DL
0.2bar (2.9psi) to 2.0bar (29psi)	D6 with lip support plate
OR	
0.2bar (2.9psi) to 4.0bar (58psi)	D7
>4.0bar (58psi)	Special D7 configurations: please consult our Technical Support Team

We recommend you use our Walkersele D6, D6/DL or D7 designs wherever possible. Between them, they cover the vast majority of radial lip seal applications across the industrial spectrum — including marine duties.

If these designs are unsuitable, please consider our alternatives, such as D1, D4, D5, TBMS or a special customised-design seal. For details of these, please refer to pages 11-13.

Where the choice is between D6 with a lip support plate and our D7 design, for pressures above 0.2bar (2.9psi), we normally recommend the well proven D7 as its robust profile is specially developed for pressure applications. If, however, low lip loading and lip flexibility are major considerations, then a D6 with a lip support plate should be considered for duties between 0.2bar (2.9psi) and 2.0bar (29psi). Please consult our Technical Support Team for all duties above 4bar (58psi).

### Step 2: Operational parameters

Determine the following for your specific application:

- Maximum under-lip working temperature of seal.** Note that under-lip temperature can often be substantially higher (eg, by 30°C or 54°F) than the fluid media temperature.
- Maximum shaft surface speed.** (Note: With D7, maximum pressure and velocity ratings may not necessarily be applied simultaneously — please consult our Technical Support Team).
- Fluid media** to be retained by the seal.

### Step 3: Seal retention method

Determine whether the seal will be **Retained** in its housing by a bolted plate, or **Self-retaining** in an open housing.

### Step 4: Performance tables

For **Retained** seals refer to **Performance Table 2** on page 5. For **Self-retaining** seals refer to **Performance Table 3** on page 5. Cross reference your suggested **Walkersele Design/s** (from Step 1), maximum working temperature, and surface speed to find the Walkersele type/s that most closely match your requirements.

### Step 5: Material compatibility

Check that the seal material/s (M1, Ultraglides K, etc) are compatible with your fluid media by referring to **Walkersele Materials** on pages 7-9. If in doubt, please consult our Technical Support Team.

### Step 6: Walkersele operational features

- Please consider and check the availability of the following options for your combinations of **Walkersele Material/Design**:
- Split or Endless** type seals. Endless types give top sealing integrity and can be used in an open housing. Split types are easier and swifter to install during plant maintenance, as the gland/shaft assembly rarely needs to be stripped down to gain access. However, abutting the seal ends is NOT recommended when shaft dynamics are severe, where the sealed fluid is under pressure or flooded conditions, or if sealing integrity is a prime consideration — therefore please consider **Walkersele OSJ-2**.
  - Walkersele OSJ-2** for On-Site Joining of split type seals for cost-effective maintenance and greatly reduced downtime (see pages 14-15).
  - Walkersele SpringSafe**: to keep the lip-energising spring securely in position during installation and operation (page 17).
  - Walkersele with Ports & Grooves**: to distribute lubricant to the lips of seals working in back-to-back formation (page 18).
  - Walkersele SpringCover**: providing external and internal corrosion protection for lip-energising springs (page 17).
  - Walkersele with Dust Lip**: (eg, Walkersele D6/DL): ‘standard’ designs with an auxiliary dust lip incorporated to prevent the ingress of contaminants in aggressive environments (page 17).
  - Walkersele Shallowback**: Walkersele D6 and D7 designs with reduced depth at the back and flexible, extended lips, for use where housing depth is limited (page 18).
  - Walkersele Long Lip**: for sealing slow rotary shafts that suffer a high degree of eccentricity (page 18).

### Step 7: Ordering your Walkersele

Please check the size of Walkersele you need against our Standard Ranges (pages 20-24) or our separate publication **Mould List for Walkersele<sup>®</sup> Radial Lip Seals**, then call your local James Walker contact as shown on the back cover or on [www.jameswalker.biz](http://www.jameswalker.biz). They will advise you of product suitability and delivery.

## Walkersele® selection

PERFORMANCE TABLE 2: Walkerseles for use with retaining plates

Walkersele® type	Material	Maximum under-lip temperature	Maximum constant surface speed	Comments
M1/D6	Nitrile (NBR)	120°C (248°F)	15m/s (2953fpm)	Most popular Walkersele for general duties
M1/D6/DL	Nitrile (NBR)	120°C (248°F)	15m/s (2953fpm)	M1/D6 with additional dust lip
M1/D7	Nitrile (NBR)	120°C (248°F)	12m/s (2362fpm)	Popular seal with pressure resistant lip
M5/D6	Butyl (IIR)	120°C (248°F)	5m/s (984fpm)	Used for its specific chemical compatibilities
M5/D6/DL	Butyl (IIR)	120°C (248°F)	5m/s (984fpm)	M5/D6 with additional dust lip
M5/D7	Butyl (IIR)	120°C (248°F)	5m/s (984fpm)	Used for its specific chemical compatibilities
Elast-O-Lion® 180 & Elast-O-Lion/ KC300/ D6	Hydrogenated nitrile (HNBR)	150°C (302°F)	15m/s (2953fpm)	For duties in hot, aggressive & abrasive conditions
Elast-O-Lion® 180 & Elast-O-Lion/ KC300/ D7	Hydrogenated nitrile (HNBR)	150°C (302°F)	12m/s (2362fpm)	With pressure resistant lip, suitable for duties in hot, aggressive & abrasive conditions
M9/D6	Fluoroelastomer (FKM)	200°C (392°F)	25m/s (4922fpm)	For high temperatures and speeds where chemical compatibility is important
M9/D6/DL	Fluoroelastomer (FKM)	200°C (392°F)	25m/s (4922fpm)	M9/D6 with additional dust lip
M9/D7	Fluoroelastomer (FKM)	200°C (392°F)	22m/s (4331fpm)	With pressure resistant lip, suitable for high temperatures, high speeds & chemicals
Ultraglide K/D6	Reformulated HNBR	150°C (302°F)	30m/s (5906fpm)	Optimised for greatly extended working life under hot & abrasive conditions
Ultraglide K/D7	Reformulated HNBR	150°C (302°F)	25m/s (4922fpm)	Seal with pressure resistant lip; offers greatly extended working life in hot & abrasive conditions
FR66/80 & FR66/ KC300/ D6	Fluoroelastomer (FKM), with non-carbon mineral fillers.	200°C (392°F)	25m/s (4922fpm)	Seal for bearings where a high level of electrical insulation is required
TBMS	Nitrile (NBR)	120°C (248°F)	2m/s (394fpm)	Tunnel boring machine seal for harsh underground environments

PERFORMANCE TABLE 3: Self-retaining Walkerseles

Walkersele® type	Material	Maximum under-lip temperature	Maximum constant surface speed	Comments
M6/D6	Nitrile (NBR)	120°C (248°F)	12m/s (2362fpm)	Most popular self-retaining Walkersele
M6/D6/DL	Nitrile (NBR)	120°C (248°F)	12m/s (2362fpm)	M6/D6 with additional dust lip
M6/D7	Nitrile (NBR)	120°C (248°F)	10m/s (1969fpm)	Popular seal with pressure resistant lip
Elast-O-Lion® 180/ D6/M	Hydrogenated nitrile (HNBR)	150°C (302°F)	15m/s (2953fpm)	For duties in hot, aggressive and abrasive conditions
Elast-O-Lion® 180/D6/ DL/M	Hydrogenated nitrile (HNBR)	150°C (302°F)	15m/s (2953fpm)	Elast-O-Lion® 180/D6/M with additional dust lip
Elast-O-Lion® 180/D7/M	Hydrogenated nitrile (HNBR)	150°C (302°F)	12m/s (2362fpm)	With pressure resistant lip, suitable for duties in hot, aggressive and abrasive conditions
M8/D6	Fluoroelastomer (FKM)	200°C (392°F)	20m/s (3937fpm)	For high temperatures and speeds where chemical compatibility is important
M8/D6/DL	Fluoroelastomer (FKM)	200°C (392°F)	20m/s (3937fpm)	M8/D6 with additional dust lip
M8/D7	Fluoroelastomer (FKM)	200°C (392°F)	18m/s (3543fpm)	With pressure resistant lip, suitable for high temperatures, high speeds and chemicals
Ultraglide D6/M	Reformulated HNBR	150°C (302°F)	15m/s (2953fpm)	Optimised for greatly extended working life under hot and abrasive conditions
Ultraglide D7/M	Reformulated HNBR	150°C (302°F)	15m/s (2953fpm)	Seal with pressure resistant lip; offering greatly extended working life

## Walkersele® profile & material combinations

Walkersele® profiles in M1, M5, M9, Elast-O-Lion® or Ultragliding materials

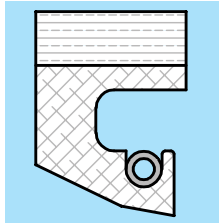

D1

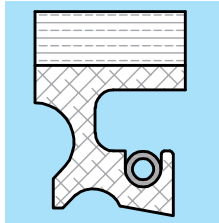

D1/DL

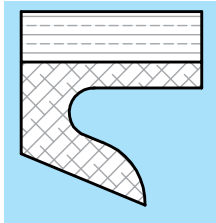

D5 Internal

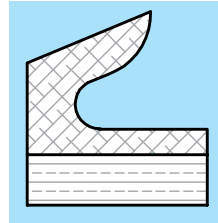

D5 External

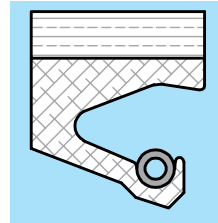

D6

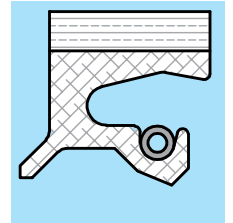

D6/DL

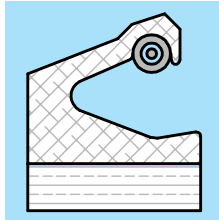

D6 External

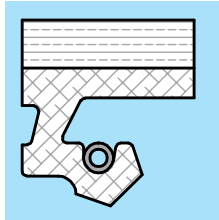

D7

Walkersele® profiles in M6, M8, Elast-O-Lion® or Ultragliding materials with 'M' backs

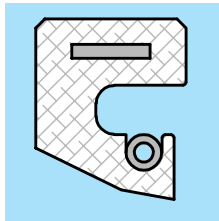

D1

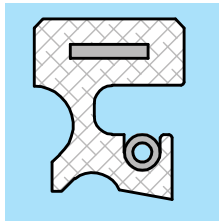

D1/DL

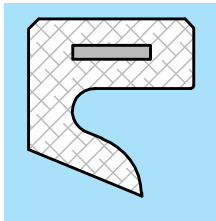

D5 Internal

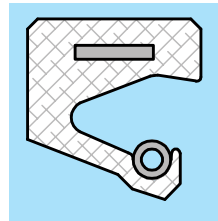

D6

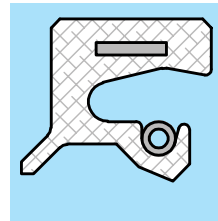

D6/DL

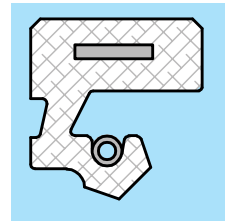

D7

Walkersele® profiles in M6, M8, Elast-O-Lion® or Ultragliding materials with 'S' backs

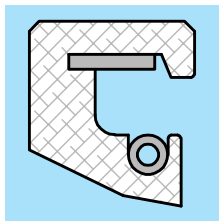

D1

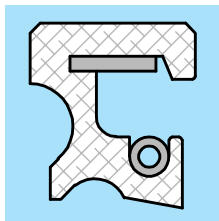

D1/DL

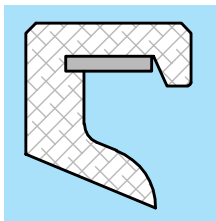

D5 Internal

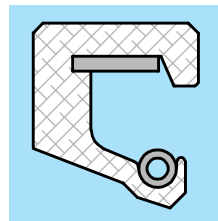

D6

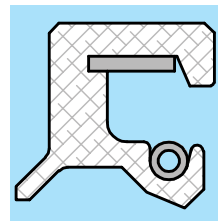

D6/DL

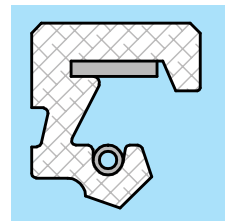

D7

Other Walkersele® profiles available

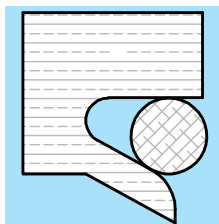

TBMS

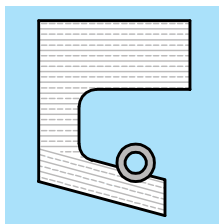

D4 Internal

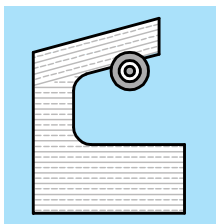

D4 External

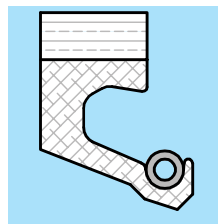

Shallowback

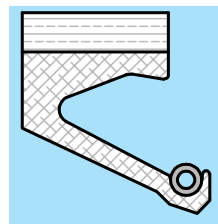

Long Lip

## Walkersele® standard materials

It is essential that the materials used in the manufacture of your Walkersele® are:

- Chemically compatible with the media to be sealed.
- Stable at the required working temperature. Note that the seal's 'under-lip' temperature can be substantially higher — by 30°C (54°F) or more — than that of the fluid being contained.
- Wear resistant at the operating conditions.
- Suitable for your operating speed.

### Standard & high performance materials

The nine elastomer-based material grades listed on this and the following two pages have been specially developed by James Walker Technology Centre for radial lip seal duties.

We compound all the elastomers in-house on a state-of-the-art internal mixer to an exacting quality regime with total traceability. Each batch of compound is subjected to rigorous testing and statistical process control before being converted to the final product.

### Customised materials

When our standard materials are unsuitable, we will tailor a compound to meet your specific operational requirements, typically for:

- Higher or lower temperature duties.
- Additional ozone resistance.
- Additional abrasion resistance.
- Eco-friendly fluid compatibility.
- Lower power consumption.

### Technical advice

If you have any special material requirements, or want advice on materials selection, please contact our Technical Support Team.

## M1 — nitrile (NBR)

The most popular material for the majority of Walkersele applications. Suits housings fitted with retaining plates.

**Media compatibility:** Suitable for use with water and the majority of oils and greases.

**Seal construction:** Flexible back of nitrile-proofed cotton fabric; lip of 80 IRHD nitrile.

**Maximum under-lip temperature:** 120°C (248°F) constant.

**Maximum surface speed:** 15m/s (2953fpm) with D6 design. 12m/s (2362fpm) with D7 design.

## M5 — butyl (IIR)

Often specified for use with media where butyl is required for chemical compatibility. Suits housings fitted with retaining plates.

**Media compatibility:** Resistant to silicone oils and greases, ozone, hot and cold water, acids, alkalis, salt solutions, alcohols, and glycols. Must NOT be used with mineral-based oils or greases.

**Seal construction:** Flexible back of butyl-proofed cotton fabric; lip of 70 IRHD butyl.

**Maximum under-lip temperature:** 120°C (248°F) constant.

**Maximum surface speed:** 5m/s (984fpm) with both D6 and D7 designs.

## M6 — nitrile (NBR)

Our most popular material for self-retaining seals used in open housings.

**Media compatibility:** Suitable for use with water and the majority of oils and greases.

**Seal construction:** Nitrile, with a steel band encapsulated in its back.

**Maximum under-lip temperature:** 120°C (248°F) constant.

**Maximum surface speed:** 12m/s (2362fpm) with D6 design. 10m/s (1969fpm) with D7 design.

## Walkersele® success

### Side thrusters & stabilisers

Cunard Line's new 90,000 tonne cruise ship MS Queen Victoria, has Walkerseles fitted as OEM equipment to protect its stabilisers and side thrusters.



Photo by courtesy of Fincantieri SpA

Built at Fincantieri's shipyard in Venice-Marghera, and cruising since December 2007, it is Cunard's second largest ever ship after the Queen Mary 2 — and the first from an Italian yard.

## Walkersele® standard materials

### M8 — fluoroelastomer (FKM)

High working temperature material for self-retaining seals in open housings.

**Media compatibility:** Excellent resistance to all lubricating oils, fuels, air, water and dilute acids.

**Seal construction:** Moulded in fluoroelastomer with steel band located in its back.

**Maximum under-lip temperature:** 200°C (392°F) constant.

**Maximum surface speed:** 20m/s (3937fpm) with D6 design. 18m/s (3543fpm) with D7 design.

### M9 — fluoroelastomer (FKM)

For high working temperatures, or where fluoroelastomer is needed to accommodate high operating speed or chemical compatibility. Suits housings fitted with retaining plates.

**Media compatibility:** Excellent resistance to all lubricating oils, fuels, air, water and dilute acids.

**Seal construction:** Flexible back of fluoroelastomer-proofed aramid/glass fabric; lip of fluoroelastomer.

**Maximum under-lip temperature:** 200°C (392°F) constant.

**Maximum surface speed:** 25m/s (4922fpm) with D6 design. 22m/s (4331fpm) with D7 design.

### Elast-O-Lion® 180 & EOL/KC300 — hydrogenated nitrile (HNBR)

High strength Elast-O-Lion® HNBR elastomer, suitable for aggressive and abrasive applications, where it provides increased wear resistance.

**Media compatibility:** Excellent resistance to all lubricating oils, fuels, air, hot and cold water, dilute acids and alkalis.

**Seal construction:** Flexible back of Elast-O-Lion proofed aramid/glass fabric; lip of Elast-O-Lion.

**Maximum under-lip temperatures:** 150°C (302°F) constant; or 170°C (338°F) constant in oil.

**Maximum surface speed:** 15m/s (2953fpm) with D6 design. 12m/s (2362fpm) with D7 design.

### FR66/80 & FR66/KC300 — fluoroelastomer (FKM) for electrical insulation duties

Special-duty fluoroelastomer-based materials. They are green in colour and suit housings fitted with retaining plates.

**Special applications:** These materials are suitable for fluid sealing duties where a high level of electrical insulation is required. They contain a non-carbon mineral filler system that has an extremely high electrical resistance.

**Media compatibility:** Excellent resistance to all lubricating oils, fuels, air, water and dilute acids.

**Seal construction:** Flexible back of FR66 fluorocarbon-proofed aramid/glass fabric; lip of FR66/80 fluoroelastomer.

**Maximum under-lip temperature:** 200°C (392°F) constant.

**Maximum surface speed:** 25m/s (4922fpm) with D6 design.

**Resistivity:**  $>3 \times 10^{13}$  ohm.cm at 500V dc (BS903 Pt C2).

### Fluolion® — PTFE

Fluolion® is James Walker's trade name for its range of polytetrafluoroethylene (PTFE) materials and products.

**Applications:** In virgin form PTFE has exceptional chemical inertness, hygiene and low-friction properties that make it invaluable for certain sealing applications in the food, pharmaceutical, bioprocessing and chemical processing sectors.

**Media compatibility:** Resistant to practically every known chemical and solvent. Only molten alkali metals, fluorine and some fluorine compounds at elevated temperatures/pressures will attack it.

**Seal construction:** Solid PTFE, precision-machined to D6 Walkersele profile. Suits housings fitted with retaining plates.

**Maximum under-lip temperature:** Will vary according to operational parameters. Please consult our Technical Support Team.

**Maximum surface speed:** Will vary according to operational parameters. Please consult our Technical Support Team.

# Walkersele® high-performance materials

These two highly-developed Walkersele® materials offer exceptional benefits to specific sectors of industry. We recommend that you discuss all applications with our Technical Support Team to determine material suitability.

## Ultraglide — hydrogenated nitrile (HNBR)

A reformulated HNBR material with optimised properties that greatly extend the working life of Walkerseles running for long periods under hot and abrasive conditions.



Walkersele® Ultraglide is the result of a five-year research programme by James Walker. In field trials on the intermediate stand of a hot rolling mill a Walkersele Ultraglide has given six times the maintenance-free life of a traditional nitrile (NBR) seal.

### Special features

- Far greater abrasion resistance for highly extended sealing life.
- Low coefficient of friction for improved running at higher speeds.
- Better heat dissipation to keep the lip cooler for high efficiency sealing.
- Broad media capability to operate with a wide range of fluids.
- Available as Endless and OSJ-2, but not as split-type seals.

**Media compatibility:** Excellent resistance to all lubricating oils, fuels, air, hot and cold water, dilute acids and alkalis.

**Seal construction:** Flexible back of HNBR-proofed aramid/glass fabric; lip of Ultraglide HNBR. Suits housings fitted with retaining plates.

**Maximum under-lip temperature:** 150° (302°F) constant, and 170°C (338°F) in oil.

**Maximum surface speed in abrasive environments:** 30m/s (5906fpm) in D6 design, or 25m/s (4922fpm) in D7 design.

**Typical applications:** Transmission systems, gearboxes and rotary plant in metallurgical industries, power generating industry, cement works, mining and quarrying, rail traction systems, etc. Suitable for use with ceramic shafts.

**Ultraglide test results:** in comparison with two other materials.

	NBR	FKM	Ultraglide HNBR
Tensile strength (MPa)	14	12	14
Max working temperature in air (°C)	100	200	150
Coefficient of dynamic friction (BS903 pt A61)	0.42	0.40	0.20
Thermal conductivity (W/m.K)	0.28	0.25	0.45
Abrasion resistance: Taber abrader H22 (volume loss, ml)	0.33	0.23	0.10

These show that our Ultraglide grade HNBR matches the strength of FKM and NBR, and provides far lower friction plus vastly superior thermal conductivity and abrasion resistance.

## Aflas® — tetrafluoroethylene/propylene (FEPM)

The combination of Walkersele® and Aflas® provides long-term protection for bearings that operate in highly aggressive chemical environments with steam — as well as in its original role for nuclear applications.



Walkersele Aflas has been re-developed by James Walker in liaison with a major manufacturer of pulp and paper plant. It solves the problem of bearing protection on dewatering presses (pulp washers) used in chemical pulping lines.

### Special features

Walkersele Aflas uses James Walker's high-performance Aflas-based AF90/LS compound that provides:

- Wide chemical compatibility.
- Excellent heat resistance.
- Continuous service capability with many aggressive media.
- Best radiation resistance of all elastomers on nuclear duties.

**Media compatibility:** Excellent resistance to the aggressive bleaching agents (particularly chlorine-free types) and high temperature water/steam used in pulping lines. Also strong acids, oils, lubricants and some fuels, weathering and ozone.

**Seal construction:** Rigid back of fibre-reinforced Aflas, with flexible Aflas sealing lip. A modified Walkersele D1 design is used for pulping lines — this features:

- Un-chamfered lip to prevent build-up of abrasive pulp materials.
- Ports and grooves to provide good inter-seal lubrication.

Walkersele Aflas is also manufactured in D6 and D7 designs for duties beyond chemical pulping lines. All designs suit housings fitted with retaining plates.

**Typical applications:** Chemical pulping lines and other processes where the combination of aggressive bleaching agents plus high temperature water and steam produce an environment where other elastomers cannot survive for long. *Note: In this environment, seals moulded in standard nitrile (NBR), hydrogenated nitrile (HNBR) or fluoroelastomer (FKM) suffer an unacceptable level of elastomer volume swell caused by chemical and physical interactions.*

**Moulding capability:** Aflas compounds are usually restricted to highly specialised duties as they are exceptionally challenging to mould accurately in complex sections for rotary seals. We have overcome these problems. Years of process engineering refinement with Aflas compounds have enabled us to perfect a unique moulding technique for Walkersele Aflas production — without the addition of other polymers to aid processing.

## Walkersele® designs

Walkersele® designs evolve constantly to meet the needs of modern rotary plant working in fast moving industrial and marine environments.

James Walker Technology Centre works at the frontiers of:

- Sealing technology.
- Materials technology.
- Tribology.
- Hydraulic fluid film theory.

Its aim is to ensure that Walkersele products are ready to meet the exacting demands of tomorrow's plant and equipment before they arise.

### Spring energised lips

Most Walkersele designs use a toroidal spring that lightly energises the flexible lip to ensure efficient sealing.

Walkerseles differ from many other manufacturers' lip seals in that they usually have no exposed metal components apart from the stainless steel spring. However, by using our SpringSafe feature (page 17) even the toroidal spring can be safely cured into the lip-groove in our most popular designs.

### Housing types — Retained and Self-retaining

Most Walkersele designs are manufactured in two versions:



**Retained:** These have an elastomer-proofed fabric back for installation in housings fitted with retaining plates. The lip and back sections are moulded together during manufacture to form a high strength intimate bond.

Retained seals are supplied endless, or as split-types for ease of fitting.

Our patented **Walkersele® OSJ-2** technique (pages 14-15) provides the ease of fitting of split-types combined with the sealing integrity of endless types.



**Self-retaining:** These have a solid back of the same moulded elastomer material as the lip. A flexible steel band is incorporated in the solid elastomer back. They are supplied only as endless types.

Walkerseles of this construction can be installed in open housings without retaining plates. (The

exception is our D7 design that operates under pressure and requires heel support when fitted facing inboard to seal an internal pressure media.)

For full housing details on Walkerseles, see pages 25-26.

## Walkersele® D6 — our most popular design

This is the standard Walkersele® design. It is suitable for a vast majority of bearing protection and other radial lip seal applications across all sectors of industry.



### Special features

- Lip profile minimises heat generation and shaft wear.
- Geometry gives lip flexibility to accommodate shaft eccentricity.
- Fabric-backed (retained) versions can be supplied in split form, and as **Walkersele OSJ-2** (pages 14-15) for On-Site Joining.
- Endless-types can be supplied with **SpringSafe** positive spring retention (page 17).
- Works at up to 0.2bar (3psi) pressure differential, or up to 2bar (29psi) with support ring (page 30).

### D6 availability — standard ranges

**JW Charts 56 and 57** (pages 20-21) cover standard ranges of our M1/D6 fabric-backed (retained) version in inch and metric sizes respectively. These seals can be supplied in either endless or split form — note the different order numbers on charts.

**JW Charts 104 and 105** (pages 22-23) cover self-retaining M6/D6 seals in inch and metric sizes respectively.

**JW Chart 376** (pages 23-24) covers self-retaining M6/D6/M seals conforming to DIN3760 and the equivalent (BS) ISO 6194 standard, as previously covered by BS1399.

### D6 availability — non-standard sizes

**Existing tools** — we have a library of over 7500 Walkersele moulds including a vast number for non-standard sizes. If the D6 size you want is not on the JW Charts, please refer to our *Mould List for Walkersele® Radial Lip Seals* publication, or contact us to check mould availability. If we have a suitable tool, your seal will be supplied on short delivery time without tooling charges.

**Specials** — new tools are swiftly made in-house for non-standard sizes. In these cases a tooling charge will be applied. Seals for shaft diameters from 25mm to 2200mm (1 inch to 87 inch) are produced by conventional moulding methods. Sizes above this, and up to unlimited diameter, are manufactured using our highly developed vulcanised mould joining technique.

## Walkersele® designs

## Walkersele® D7 — pressure resistant lip seal

This is our second most popular design. Its robust profile suits pressure applications such as ships' stabilisers and bow thrusters as well as process plant.

**Special features**

- Works at up to 4bar (58psi) pressure differential. To achieve this the heel of the seal lip must always be supported.
- No costly profiled lip-support plates are needed.
- Flexible and robust lip maintains sealing contact on misaligned or eccentric shafts.
- Self-retaining seals can be used with open housings when sealing external fluids — but retaining plate is needed to support heel of seal lip when seal is fitted facing inboard.
- Fabric-backed (retained) version can be supplied as split-type, and as **Walkersele® OSJ-2** (pages 14-15) for On-Site Joining.
- Endless-types can be supplied with **SpringSafe** positive spring retention (page 17).

**D7 availability**

**Existing tools** — our tool library covers all popular D7 sizes and many non-standards. Please refer to our *Mould List for Walkersele® Radial Lip Seals* publication, or contact us to check mould availability. Where we have a suitable tool, your seal will be supplied on short delivery without tooling charges.

**Specials** — new tools are swiftly made in-house for non-standard sizes. In these cases a tooling charge will be applied. Seals for shaft diameters from 30mm to 2200mm (1.2 inch to 87 inch) are produced by conventional moulding methods. Sizes above this, and up to unlimited diameter, are manufactured using our highly developed vulcanised mould joining technique.

## Walkersele® D1 — original design

A non-chamfered lip design, given a new lease of life with Walkersele Aflas® for chemical pulping lines in the pulp and paper industry, where its square leading edge prevents fibre ingress.

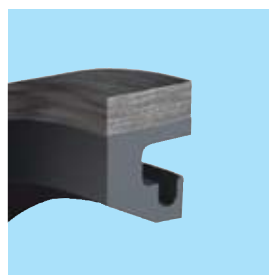
**Special features**

- Aflas version, with ports and grooves, provides long-term protection for bearings of dewatering presses at pulp works (see page 9).
- Fabric-backed (retained) version can be supplied as split-type or **Walkersele® OSJ-2** (pages 14-15) for On-Site Joining.

**D1 availability**

**Existing tools** — we hold many tools for this original standard design, plus specific sizes for the modified Walkersele Aflas version. Please contact us to check mould availability. Where we have a suitable tool, your seal will be supplied on short delivery time without tooling charge.

**Specials** — new tools are swiftly made in-house for non-standard sizes. In these cases a tooling charge will be applied. Seals for shaft diameters from 25mm to 2200mm (1 inch to 87 inch) are produced by conventional moulding methods. Sizes above this, and up to unlimited diameter, are manufactured using our highly developed vulcanised mould joining technique.

## Walkersele® designs

### Walkersele® D5 — compact design

A radial lip seal design for very small sections.

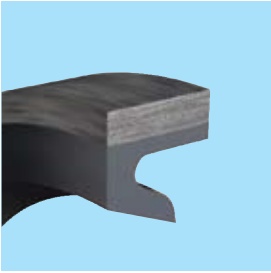

#### Special features

- Very compact design, often used in endless form.
- Feathered lip needs no lip spring for operation.
- Seal can be used where space limitations prevent installation of a lip spring.
- Can be supplied with external lip for duties where sealing on inner periphery is impractical.

#### Walkersele D5 availability

**Existing tools** — we hold a number of tools for this design in both lip modes. Please contact us to check mould availability. Where we have a suitable tool, your seal will be supplied on short delivery time without tooling charges.

**Specials** — new tools are swiftly made in-house. In these cases a tooling charge will be applied.

### Walkersele® D4 — slow rotary duties

An early design of Walkersele® that proves very efficient on slow rotary duties with highly abrasive media.

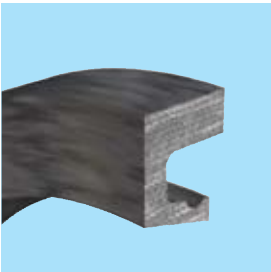

#### Special features

- Moulded entirely in elastomer-proofed fabric for abrasion resistance.
- Suitable only for slow rotary duties with minimal shaft eccentricity. Pulverising mills are a typical application.

#### Walkersele D4 availability

This seal has been largely superseded by Walkersele® TBMS. However, we still hold mould tools to satisfy the requirements of existing users and applications. Please contact us to check

mould availability. Where we have a suitable tool, your seal will be supplied on short delivery time without tooling charges.

### Walkersele® TBMS — tunnel boring machine seal

Proven on many major projects, including Channel Tunnel (7.8m/25.6ft diameter) and Airport Link Railway, Sydney (11m/36ft diameter).

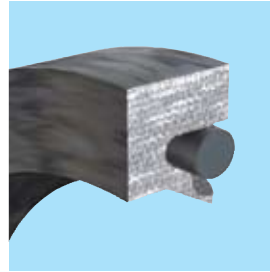

#### Special features

- Exceedingly robust radial lip seal to work for the life of a tunnelling project.
- Manufactured from tough, abrasion-resistant elastomer-proofed fabric.
- Banks of seals are installed to protect the bearings of a TBM's cutting head from water, slurries, abrasive material, etc.
- Works at constant 3bar (43.5psi) pressure differential with emergency excursions to 4bar (58psi). Maximum static pressure is 10bar (145psi).
- Maximum shaft speed is 2m/s (394fpm).

#### Walkersele® TBMS availability

We hold a number of standard section continuous mould tools for the production of large diameter TBMS endless seals. Please refer to our *Mould List for Walkersele® Radial Lip Seals* publication. As tunnel boring machines are usually custom-built for each tunnelling project, please contact our Technical Support Team at concept design stage to discuss sealing requirements in detail.

## Customised designs

### Custom design in action

The design of customer-specific seals is a James Walker speciality. We constantly develop, prototype and prove many new lip seals in partnership with major equipment manufacturers and end users to solve their fluid sealing problems. This is a service that only a few fluid seal companies can provide.

We cover the subject here in general terms only because most of our work at this level involves confidentiality agreements.

Our custom design operation is led by the James Walker Technology Centre that combines Materials, Application and Field Engineering Teams.

Staffed with highly experienced engineers, materials technologists and chemists, this group has the proven ability and technical facilities to study clients' fluid sealing problems and create the *best value* working solutions.



The main benefits offered by James Walker include

- Innovative design capability.
- Extremely comprehensive range of high performance elastomers and other materials.
- Fulllest knowledge of seal and elastomer manufacturing technologies.

These skills are backed by many years' experience of working closely with engineers across all sectors of industry, and a fundamental understanding of all types of equipment that need fluid sealing components.

The group can also use non-linear FEA (finite element analysis) techniques for modelling its seal designs and fine-tuning different aspects, such as lip geometry and materials specification, to obtain the required performance.

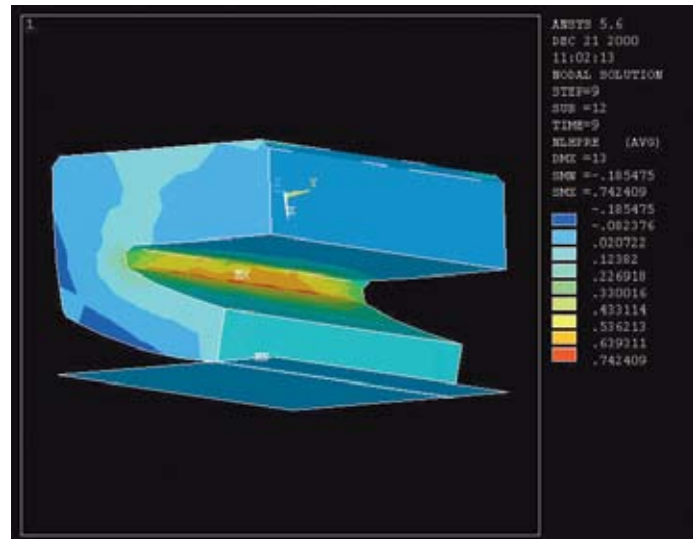

These developments then move to prototypes that are fully tested on a suite of static and dynamic test rigs to simulate closely the true operating conditions. Only when both James Walker Technology Centre and our client are fully satisfied with test rig results will the new seal be subjected to field trials on a working plant.

Successes on high-profile development projects produce very positive feed back. The resulting improvements achieved in seal performance — in terms of operational life, sealing integrity, and the ability to work under extreme conditions — are greatly appreciated by James Walker's customers on a worldwide basis.



## Walkersele® OSJ-2 for On-Site Joining

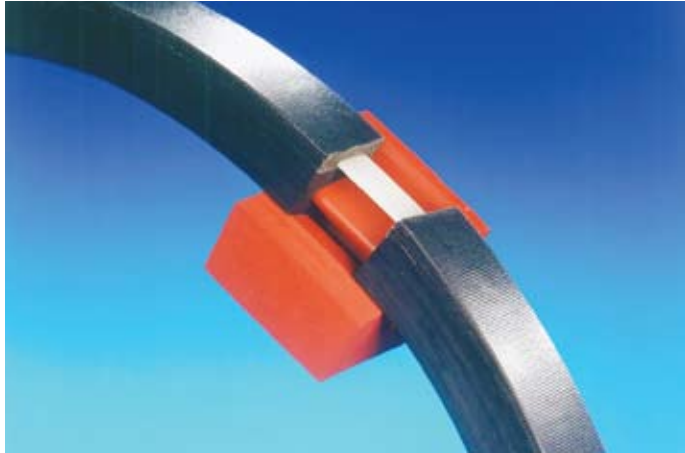

Walkersele® OSJ is our patented and highly successful technique for the On-Site Joining of split-type Walkerseles. Its many benefits include:

- **High performance** — installed units provide the sealing performance of high-integrity endless Walkerseles.
- **Worldwide proven** — on marine propulsion systems, gearboxes, power stations, sugar refineries, etc...
- **Cost effective maintenance** — the performance and integrity of an endless-type seal is achieved:
  - ▶ without major plant strip-down
  - ▶ without expensive on-site vulcanising.

### Walkersele® OSJ — background to success

Innumerable improvements in Walkersele® materials and design have been introduced over the past 50 years.

One of these was the split-type seal that proved invaluable where gland and shaft assemblies had to be dismantled to fit a moulded endless seal. This development drastically cut the costs of plant downtime and maintenance man-hours.

However, normal split seals are not penalty-free, as sealing performance can be affected when shaft dynamics are severe. Abutting the ends is still a viable option if a small degree of leakage is acceptable.

On-site vulcanising was, for many years, the only answer to split seal assemblies where leakage was unacceptable. But this process could prove expensive, as it needed a high degree of skill and elaborate jigs. So, we developed Walkersele OSJ.

Since the introduction of Walkersele OSJ in 1991, rotary lip seal replacement has come full circle, to form a full circle again. After a few hours' hands-on training, a maintenance fitter is able to produce a securely bonded joint that provides Walkersele with the integrity of a fully moulded endless seal. Fitting procedure is straightforward, as shown alongside.

### Why Walkersele® OSJ-2?

This is the original proven Walkersele OSJ system, supplied with a modified fitting kit that makes it easier to install.

In consultation with long-term OSJ® customers, we have modified the installation kit to make it easier and more efficient to use under arduous maintenance conditions and at larger seal diameters.

With Walkersele OSJ-2 you get exactly the same top-quality lip seal and high technology joining system as with our original Walkersele OSJ system. The improvements include:

- New user-friendly clamping band with finer tension control.
- Redesigned jig to provide a more positive location of seal join.
- Improved temperature indicator.
- Availability in larger diameters.

### Fitting procedure



**Stage 1:** Apply epoxy adhesive to joining faces of Walkersele® OSJ-2.



**Stage 2:** Align join in moulded jig.



**Stage 3:** Clamp into position with steel band.



**Stage 4:** Cure epoxy adhesive with hot air gun.

## Walkersele® OSJ-2

## OSJ-2 On-Site Joining kit

**Kit components**

- Walkersele® — specially adapted at joint interface for OSJ® installation.
- Steel clamping band.
- Nut driver to adjust clamping band.
- Joining jig — precision moulded in synthetic elastomer.
- Two-part epoxy adhesive in sachet (adhesive cures to semi-rigid state).
- Adhesive applicator brush.
- Degreasing cloth.
- Abrasive stick.
- Emery paper with self-adhesive backing.
- Temperature indicator with self-adhesive backing (Note: hot air gun is needed to affect adhesive cure).
- Step-by-step instructions.

## Training

Successful application of the Walkersele® OSJ technique relies on careful adherence to all stages of the joining process — as laid down in the full instructions supplied with each kit.

We recommend that first-time users attend one of our hands-on training sessions. These can be carried out at your premises or one of our sites.

For details, please contact our Technical Support Team or your local James Walker distributor.

## Seal availability

**Profiles**

Walkersele® OSJ-2 is supplied in all Walkersele designs that incorporate seal backs moulded from rubberised fabric. The relevant profiles are:

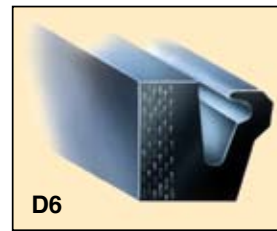

D6

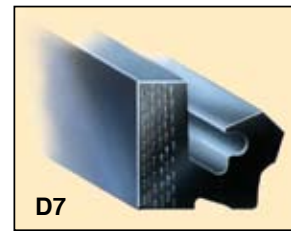

D7



D6/DL



D5



D1/DL



D1

In addition, some TBMS (tunnel boring machine seal) profiles may be suitable for On-Site Joining.

**Materials**

Walkersele OSJ-2 is supplied in the following elastomer grades: nitrile (NBR), fluorocarbon (FKM), hydrogenated nitrile (HNBR), and Ultraglide. These relate in particular to our Walkersele materials M1, M9, Elast-O-Lion® 180, Elast-O-Lion/KC300, and Ultraglide K (see pages 7-9).

**Temperature limit**

This is dependent on the seal material. It should also be noted that the bonding technique imposes an upper limit of 150°C (302°F) on the seal.

**Sizes**

Walkersele OSJ-2 kits are readily supplied for shaft sizes from 60mm to 2000mm (2.4 inch - 78.75 inch). When considering diameters outside this range, please contact our Technical Support Team for advice.

**Performance envelope**

If you need further guidance or performance data, please discuss exact details of media compatibility, pressure, temperature and surface speeds with our Technical Support Team.

## Special arrangements for worn shafts

We offer a package of solutions to the problem of shaft wear created beneath the lip position when standard radial lip seals have run under arduous conditions for long periods.

### Walkersele® Cartridges

- One or more Walkerseles housed in a custom-designed cartridge allows the seal lip to be located away from areas of shaft wear.
- A split-type cartridge that simply bolts on to the existing equipment face will extend the life of the equipment without the need for major strip-down, shaft reconditioning or replacement.
- Walkersele® cartridges are also custom designed to overcome other problems, including bearing protection for pumps handling highly abrasive media, eccentric shaft action, and long-term sealing with minimised downtime for seal refurbishment.

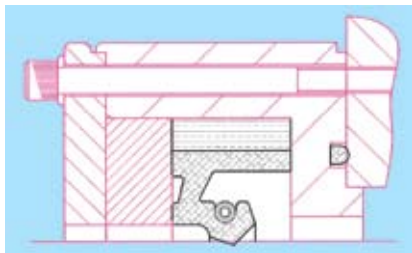

**Single seal & spacer**  
Spacer ring enables the Walkersele lip to be repositioned to avoid shaft wear or damage. This cartridge arrangement shows common bolting for seal and cartridge. Separate bolting is available.

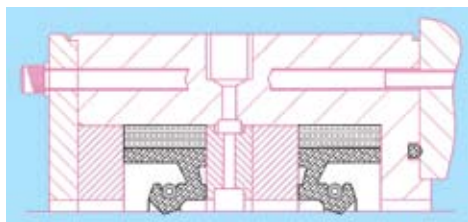

**Double seal arrangements**  
These use two Walkerseles in a cartridge, along with various spacers and/or different widths

of lantern ring. By varying the sizes and positions of these components, the sealing elements are accurately positioned to run on specific areas of the shaft.

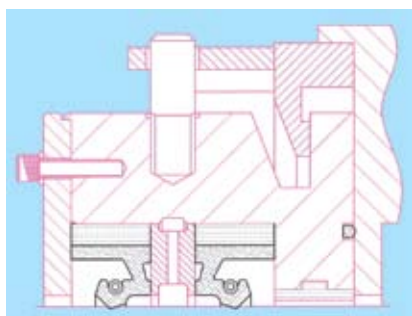

**Floating cartridge**  
This arrangement allows the sealing elements to follow the eccentric movement of worn or misaligned shafts. It is usually applied to large diameter shafts that rotate slowly.

### Walkersele® Cartridge availability

Supplied as complete customised package following an on-site assessment of your application. Installation and refurbishment services are also available. Please contact our Technical Support Team.

### Spacer rings

These allow a Walkersele®, or combination of seals, to be relocated within a housing so that the lip/s bear on a different area of shaft surface.

When fitted in new equipment, a spacer ring allows sealing lip positions to be readily altered when shaft wear has occurred after a long period of operation. When retrofitting to an existing application, it may be necessary to modify the housing and retaining plate to accommodate the spacer ring/s.

With two (or more) Walkersele D7 seals in a housing, spacer rings must be installed between the seals to support the heel of the seal. This applies equally to seals in series — facing in or facing out — and in back-to-back formation.

### Spacer ring availability

Rings are supplied to order to suit specific Walkersele/housing configurations. They are available in various materials, with nylon or stainless steel proving most popular. Please contact our Technical Support Team for recommendations.

### Walkersele® Shaft Sleeves

Our sleeves will protect your shaft from wear and present the optimum running surface for Walkersele® radial lip seals. We can provide them in either endless or split form.



The sleeves are precision manufactured in corrosion-resistant steel or non-ferrous alloys, to suit the operating conditions, and can be supplied with hard surface layers when required.

Our split-type sleeves feature a taper-wedge location and locking system that ensures perfect alignment of the split halves.



### Shaft sleeve availability

Custom-designed and manufactured to suit each specific application. Please contact our Technical Support Team.

## Special features

Our list of Walkersele® special features grows constantly as we introduce new developments to improve the efficiency of our products under specific operating conditions. Here are a few examples.

### Walkersele® SpringSafe



Our specially developed SpringSafe technique:

- Provides positive spring retention for Walkersele® D6 and D7 radial lip seals.
- Intimately cures the lip-energising spring into the spring groove to keep the spring securely in position during installation and operation.
- Allows spring coils to move freely for efficient lip seal operation.

With SpringSafe, plant operators enjoy peace-of-mind that the lip-energising springs on their endless-type seals are properly located at installation and cannot readily be dislodged to create secondary damage when a shaft or bearing runs beyond recommended operating limits.

SpringSafe is particularly beneficial on sealing duties where unprotected springs are subjected to the corrosive or abrasive media found in metallurgical processing, marine applications, pulp and paper processing, and petrochemical processing.

#### Walkersele SpringSafe materials

SpringSafe is currently available for Walkerseles that are precision moulded in:

- Nitrile (NBR) elastomer — ie, materials M1 and M6 (page 7).
- Hydrogenated nitriles (HNBR) — including our Elast-O-Lion® and reformulated HNBR Ultraglide grades (pages 8-9).

#### Walkersele SpringSafe sizes

Shafts of 250mm (9.8 inch) diameter and above can be supplied with Walkersele radial lip seals incorporating the SpringSafe method of positive spring retention — however, the seal section must be 14.4mm (0.57 inch) or greater for efficient operation.

For SpringSafe on smaller diameter shafts and non-standard sizes, please refer to our Technical Support Team. We are constantly developing and proving extensions to our Walkersele family, so we may well be able to meet your request.

### Walkersele® SpringCover

Walkersele® lip-energising springs are supplied as standard in stainless steel, with other materials such as Inconel® available to order.

However, when the seals must operate under extremely corrosive conditions — such as highly oxygenated marine environments — it may be necessary to provide additional protection for the spring by means of Walkersele® SpringCover.

With Walkersele SpringCover, we encase the spring in polyolefin then flush and vacuum fill the inside of the spring with corrosion inhibitor. This combination prevents external fluids from attacking the spring and greatly reduces the possibility of corrosion occurring within the coils.

### Walkersele® with Dust Lip

Special versions of our D6 and D1 designs have an auxiliary 'dust lip' incorporated to prevent the ingress of liquid or solid contaminants in aggressive industrial environments. Dust lip (DL) versions are often installed when there is insufficient space to fit two standard seals in a housing.

#### Special features

- Seals efficiently in two directions.
- Needs a smaller housing than double seal (back-to-back) arrangements often used for two-way sealing.
- Fabric-backed versions can be supplied as split types, and as Walkersele® OSJ-2 (pages 14-15) for On-Site Joining.

#### DL availability

**Existing tools** — we hold many tools for D6/DL and D1/DL. Please refer to our *Mould List for Walkersele® Radial Lip Seals* publication, or contact us to check tool availability. Where we have a suitable tool, your seal will be supplied on short delivery time without tooling charges.

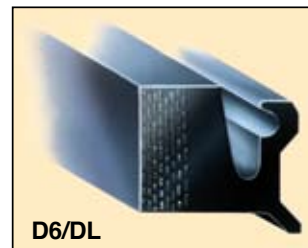

**New tools** — are swiftly made in-house when the size you need does not exist. In these cases a tooling charge will be applied.

## Special features

### Walkersele® Shallowback designs

These modified versions of Walkersele® D6 and D7 designs have reduced depth at the back, plus flexible, extended lips.

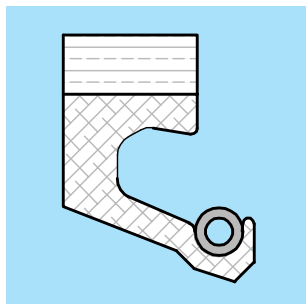

Walkersele® D6 Shallowback

#### Special features

- Suitable for duties where housing depth limitations preclude the use of standard Walkerseles.
- Can be moulded with the extended lip and standard back for duties where shaft eccentricity is high (*Please consult our Technical Support Team*).
- Shallowback with the extended lip is available for use with angular shaft displacement on spherical bearings/couplings.
- D7 Shallowback is used as a wiper (eg, on automatic gauge control units) where it prevents the ingress of foreign matter.

#### D6 & D7 Shallowback availability

**Existing tools** — we hold a limited number of tools for these designs. Please contact us to check mould availability. Where we have a suitable tool, your seal will be supplied on short delivery time without tooling charges.

**New tools** — are swiftly made in-house when the size you need does not exist. In these cases a tooling charge will be applied.

### Walkersele® Long Lip

This modified version of our D6 design incorporates a long lip for sealing applications that involve slow rotary shafts suffering a high degree of eccentricity, or where clearances between the shaft and housing are excessive.

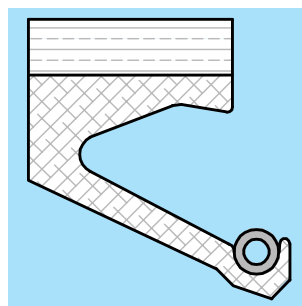

#### Walkersele® Long Lip availability

**Existing tools** — we hold a limited number of tools for this design. Please contact us to check availability. Where we have a suitable tool, your seal will be supplied on short delivery time without tooling charges.

**New tools** — are swiftly made in-house when the size you need does not exist. In these cases a tooling charge will be applied.

### Walkersele® with ports & grooves

There are many sealing arrangements where two seals are fitted back-to-back in the same housing — eg, rolling mill bearings — and it is possible that one or both will run dry unless lubricant is supplied from an external source.

This can be accomplished by introducing a lubricant flow through the chock to the junction of the two Walkerseles. Using Walkerseles that are specially manufactured with an annular groove and radial ports in their backs allows the lubricant to distribute to the lips of both seals.

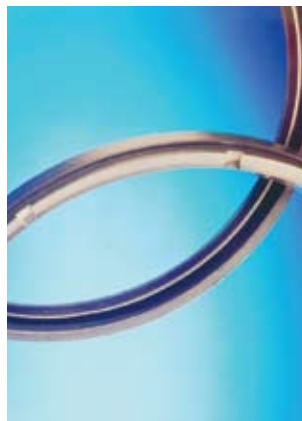

Walkersele® with ports and grooves

Alternative methods are to machine an annular groove in the housing and use Walkerseles that are manufactured with radial ports, or to install a lantern ring between the seals — albeit this may increase the depth of housing required.

Annular grooves can be provided in Walkerseles of 12.5mm (0.5 inch) section width or greater. Axial ports can be provided on any size of Walkersele.

## Special features

### Endless-type Walkerseles

All Walkerseles are available in endless form, as a complete ring. However, self-retaining types (ie, M6 and M8 materials) for use in open housings are supplied **only** in endless form as they have a flexible metal band encapsulated in the back.

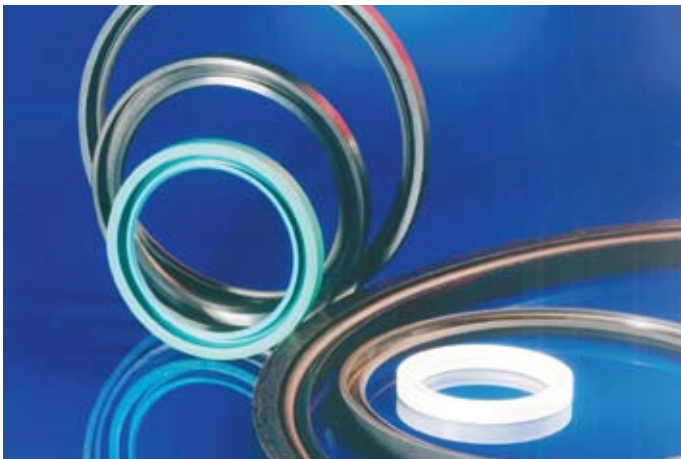

The main benefit of endless seals is their high integrity sealing capability. But this is often mitigated by the maintenance downtime required for their installation, especially on shaft bearings where the shaft may need to be removed for access.

Hence the development of split-type seals and our patented **Walkersele OSJ-2 On-Site Joining** technique (pages 14-15).

### Split-type Walkerseles

Walkerseles with a flexible back of elastomer-proofed fabric can be provided as split-types for ease of installation. These include M1, M5, M9, and Elast-O-Lion® 180 & Elast-O-Lion/KC300 material types. Aflas® grades can also be supplied split, but their special benefits with abrasive or chemically aggressive media may be compromised.

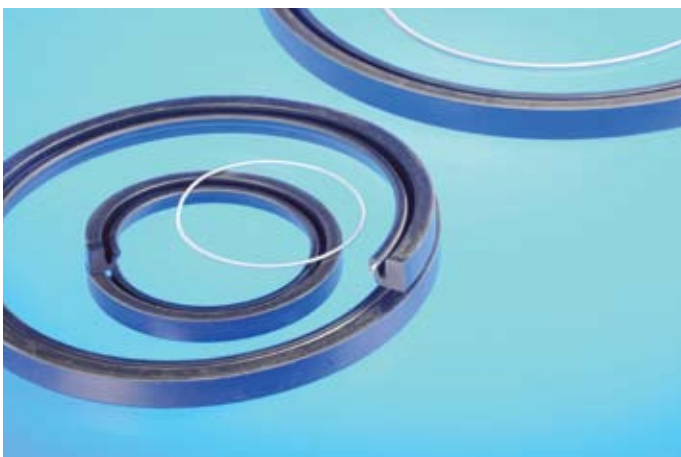

A split-type Walkersele is manufactured with a solid elastomer insert where the split is formed. This gives a rubber-to-rubber mating face in the seal's body for close and accurate abutment when the seal is in position. Installation is simple, as the seal is easily opened out around the shaft, the ends mated, and the toroidal lip-energising spring screwed together.

However, the sealing performance of split type seals can be affected when shaft dynamics are severe, and a small degree of leakage past the abutted ends is always possible.

Our patented **Walkersele OSJ-2 On-Site Joining** technique overcomes these problems (pages 14-15).

### Walkersele® success

#### Hydropower turbine

*Turbine shaft seals on an EDF hydroelectric scheme at Villeneuve, France, have been converted to Walkersele using James Walker's patented OSJ® On-Site Joining technique.*

*Three Walkersele D7 seals running on a tungsten carbide coated shaft sleeve were fitted in less than three hours.*

*The original sealing system on the 13MW bulb type turbine proved difficult to keep in good condition in the highly abrasive and corrosive river flow. The Walkerseles last significantly longer, seal more efficiently and are far easier to maintain.*



### Walkersele® success

#### Wind turbines

*Wind power technology company NEG Micon of Denmark uses 1800mm diameter Walkerseles to protect the slew ring mechanism that keeps the head of its 900kW turbines facing into wind.*

*A special Walkersele® was custom designed and moulded with an extra dust lip for this application.*



# Walkersele® M1/D6 standard range

## Walkersele® M1/D6

JW Charts 56 and 57, as shown on these two pages, contain our standard ranges of Walkersele® M1/D6 seals for use in housings with retaining plates.

- Chart 56 covers inch size seals.
- Chart 57 covers metric sizes.

All these seals are available ex-stock.

When ordering, please quote the appropriate *JW Order Code*, which differentiates between endless-type and split-type seals.

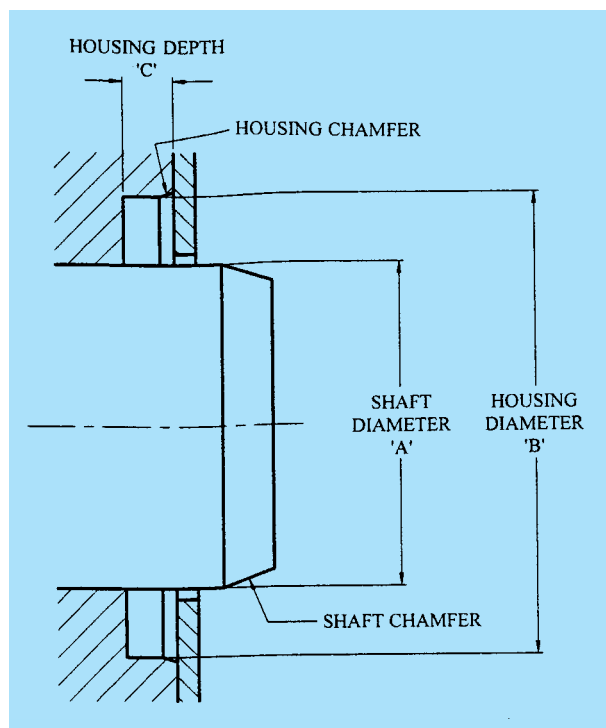

**JW Chart 56:**  
Walkersele® M1/D6 — inch sizes

Shaft Dia A	Housing Dia B	Housing Depth C	JW Part No.	JW Order Code ENDLESS	JW Order Code SPLIT
1	1 7/8	3/8	56-100	WG-000259	WG-010254
1 1/8	2	3/8	56-112	WG-000283	WG-010289
1 1/4	2 1/8	3/8	56-125	WG-000313	WG-010319
1 3/8	2 1/4	3/8	56-137	WG-000348	WG-010343
1 1/2	2 1/2	7/16	56-150	WG-000380	WG-010386
1 5/8	2 5/8	7/16	56-162	WG-000410	WG-010416
1 3/4	2 3/4	7/16	56-175	WG-000445	WG-010440
1 7/8	2 7/8	7/16	56-187	WG-00047X	WG-010475
2	3	7/16	56-200	WG-00050X	WG-010505
2 1/8	3 1/8	7/16	56-212	WG-000534	WG-01053X
2 1/4	3 1/4	7/16	56-225	WG-000577	WG-010572
2 3/8	3 3/8	7/16	56-237	WG-000607	WG-010602
2 1/2	3 1/2	7/16	56-250	WG-000631	WG-010637
2 3/4	4	1/2	56-275	WG-000690	WG-010696
3	4 1/4	1/2	56-300	WG-000763	WG-010769
3 1/4	4 1/2	1/2	56-325	WG-000828	WG-010823
3 1/2	4 3/4	1/2	56-350	WG-000887	WG-010882
3 3/4	5	1/2	56-375	WG-00095X	WG-010955
4	5 1/4	1/2	56-400	WG-001018	WG-011013
4 1/4	5 3/4	5/8	56-425	WG-001077	WG-011072
4 1/2	6	5/8	56-450	WG-00114X	WG-011145
4 3/4	6 1/4	5/8	56-475	WG-001204	WG-01120X
5	6 1/2	5/8	56-500	WG-001271	WG-011277
5 1/4	6 3/4	5/8	56-525	WG-001336	WG-011331
5 1/2	7	5/8	56-550	WG-001395	WG-011390
5 3/4	7 1/4	5/8	56-575	WG-001468	WG-011463
6	7 1/2	5/8	56-600	WG-001522	WG-011528
6 1/4	7 3/4	5/8	56-625	WG-001581	WG-011587
6 1/2	8	5/8	56-650	WG-001654	WG-01165X
6 3/4	8 1/4	5/8	56-675	WG-001719	WG-011714
7	8 1/2	5/8	56-700	WG-001778	WG-011773
7 1/2	9	5/8	56-750	WG-001905	WG-011900
8	9 1/2	5/8	56-800	WG-002030	WG-012036
8 1/2	10	5/8	56-850	WG-002154	WG-01215X
9	10 1/2	5/8	56-900	WG-002286	WG-012281
9 1/2	11	5/8	56-950	WG-002413	WG-012419
10	11 1/2	5/8	56-1000	WG-002545	WG-012540
10 1/2	12 1/4	3/4	56-1050	WG-002669	WG-012664
11	12 3/4	3/4	56-1100	WG-002790	WG-012796
11 1/2	13 1/4	3/4	56-1150	WG-002928	WG-012923
12	13 3/4	3/4	56-1200	WG-003045	WG-013040
13	14 3/4	3/4	56-1300	WG-003304	WG-01330X
14	15 3/4	3/4	56-1400	WG-00355X	WG-013555
15	16 3/4	3/4	56-1500	WG-003819	WG-013814

All dimensions in inches

## Walkersele® M1/D6 standard range

**JW Chart 57:**  
Walkersele® M1/D6 — metric sizes

Shaft Dia A	Housing Dia B	Housing Depth C	JW Part No.	JW Order Code ENDLESS	JW Order Code SPLIT
25	47	10	57-25	WG-02025X	WG-030255
30	52	10	57-30	WG-020306	WG-030301
32	54	10	57-32	WG-020322	WG-030328
35	57	10	57-35	WG-020357	WG-030352
38	63	11	57-38	WG-020381	WG-030387
40	65	11	57-40	WG-020403	WG-030409
42	67	11	57-42	WG-02042X	WG-030425
43	68	11	57-43	WG-020438	WG-030433
45	70	11	57-45	WG-020454	WG-03045X
50	75	11	57-50	WG-020500	WG-030506
53	78	11	57-53	WG-020535	WG-030530
55	80	11	57-55	WG-020551	WG-030557
58	83	11	57-58	WG-020586	WG-030581
60	85	11	57-60	WG-020608	WG-030603
65	90	11	57-65	WG-020659	WG-030654
68	100	12.5	57-68	WG-020683	WG-030689
70	102	12.5	57-70	WG-020705	WG-030700
73	105	12.5	57-73	WG-02073X	WG-030735
75	107	12.5	57-75	WG-020756	WG-030751
80	112	12.5	57-80	WG-020802	WG-030808
82	114	12.5	57-82	WG-020829	WG-030824
85	117	12.5	57-85	WG-020853	WG-030859
88	120	12.5	57-88	WG-020888	WG-030883
90	122	12.5	57-90	WG-02090X	WG-030905
93	125	12.5	57-93	WG-020934	WG-03093X
95	127	12.5	57-95	WG-020950	WG-030956
97	129	12.5	57-97	WG-020977	WG-030972
100	132	12.5	57-100	WG-021000	WG-031006
105	145	16	57-105	WG-021051	WG-031057
110	150	16	57-110	WG-021108	WG-031103
115	155	16	57-115	WG-021159	WG-031154
120	160	16	57-120	WG-021205	WG-031200
125	165	16	57-125	WG-021256	WG-031251
130	170	16	57-130	WG-021302	WG-031308
135	175	16	57-135	WG-021353	WG-031359
140	180	16	57-140	WG-02140X	WG-031405
145	185	16	57-145	WG-021450	WG-031456
150	190	16	57-150	WG-021507	WG-031502
155	195	16	57-155	WG-021558	WG-031553
160	200	16	57-160	WG-021604	WG-03160X
165	205	16	57-165	WG-021655	WG-031650
166	206	16	57-166	WG-021663	WG-031669
170	210	16	57-170	WG-021701	WG-031707
175	215	16	57-175	WG-021752	WG-031758
180	220	16	57-180	WG-021809	WG-031804
185	225	16	57-185	WG-02185X	WG-031855
190	230	16	57-190	WG-021906	WG-031901
195	235	16	57-195	WG-021957	WG-031952
200	240	16	57-200	WG-022007	WG-032002
205	245	16	57-205	WG-022058	WG-032053
210	250	16	57-210	WG-022104	WG-03210X
215	255	16	57-215	WG-022155	WG-032150
220	260	16	57-220	WG-022201	WG-032207

**JW Chart 57:**  
Walkersele® M1/D6 — metric sizes (continued)

Shaft Dia A	Housing Dia B	Housing Depth C	JW Part No.	JW Order Code ENDLESS	JW Order Code SPLIT
225	265	16	57-225	WG-022252	WG-032258
230	270	16	57-230	WG-022309	WG-032304
235	275	16	57-235	WG-02235X	WG-032355
240	280	16	57-240	WG-022406	WG-032401
245	285	16	57-245	WG-022457	WG-032452
250	290	16	57-250	WG-022503	WG-032509
255	299	20	57-255	WG-022554	WG-03255X
260	304	20	57-260	WG-022600	WG-032606
265	309	20	57-265	WG-022651	WG-032657
270	314	20	57-270	WG-022708	WG-032703
275	319	20	57-275	WG-022759	WG-032754
280	324	20	57-280	WG-022805	WG-032800
285	329	20	57-285	WG-022856	WG-032851
290	334	20	57-290	WG-022902	WG-032908
295	339	20	57-295	WG-022953	WG-032959
296	340	20	57-296	WG-022961	WG-032967
300	344	20	57-300	WG-023003	WG-033009
305	349	20	57-305	WG-023054	WG-03305X
310	354	20	57-310	WG-023100	WG-033106
320	364	20	57-320	WG-023208	WG-033203
325	369	20	57-325	WG-023259	WG-033254
330	374	20	57-330	WG-023305	WG-033300
340	384	20	57-340	WG-023402	WG-033408
350	394	20	57-350	WG-02350X	WG-033505
360	404	20	57-360	WG-023607	WG-033602
370	414	20	57-370	WG-023704	WG-03370X
380	424	20	57-380	WG-023801	WG-033807
390	434	20	57-390	WG-023909	WG-033904
400	444	20	57-400	WG-02400X	WG-034005
413	463	22	57-413	WG-024131	WG-034137
420	470	22	57-420	WG-024204	WG-03420X
430	480	22	57-430	WG-024301	WG-034307
440	490	22	57-440	WG-024409	WG-034404
450	500	22	57-450	WG-024506	WG-034501
455	505	22	57-455	WG-024557	WG-034552
460	510	22	57-460	WG-024603	WG-034609
475	525	22	57-475	WG-024751	WG-034757
480	530	22	57-480	WG-024808	WG-034803
485	535	22	57-485	WG-024859	WG-034854
500	550	22	57-500	WG-025006	WG-035001
530	580	22	57-530	WG-025308	WG-035303
540	590	22	57-540	WG-025405	WG-035400
560	610	22	57-560	WG-02560X	WG-035605
580	630	22	57-580	WG-025804	WG-03580X
600	650	22	57-600	WG-026002	WG-036008
650	714	25	57-650	WG-026509	WG-036504
660	724	25	57-660	WG-026606	WG-036601
700	764	25	57-700	WG-027009	WG-037004
750	814	25	57-750	WG-027505	WG-037500
790	854	25	57-790	WG-027904	WG-03790X
800	864	25	57-800	WG-028005	WG-038000
820	884	25	57-820	WG-02820X	WG-038205
830	894	25	57-830	WG-028307	WG-038302
970	1034	25	57-970	WG-029702	WG-039708
1000	1064	25	57-1000	WG-029990	WG-039996

All dimensions in mm

# Walkersele® M6/D6 standard range

## Walkersele® M6/D6

JW Charts 104, 105 and 376, as shown on the following three pages, contain our standard ranges of self-retaining Walkersele® M6/D6 seals for use with open housings.

- Chart 104 covers inch size seals.
- Chart 105 covers metric sizes.
- Chart 376 covers seals conforming to the widely used DIN3760 and the equivalent (BS) ISO 6194 standard, as previously covered by BS1399.

All these seals are available ex-stock.

When ordering, please quote the appropriate *JW Order Code*. As these seals are self-retaining they are supplied only as endless types.

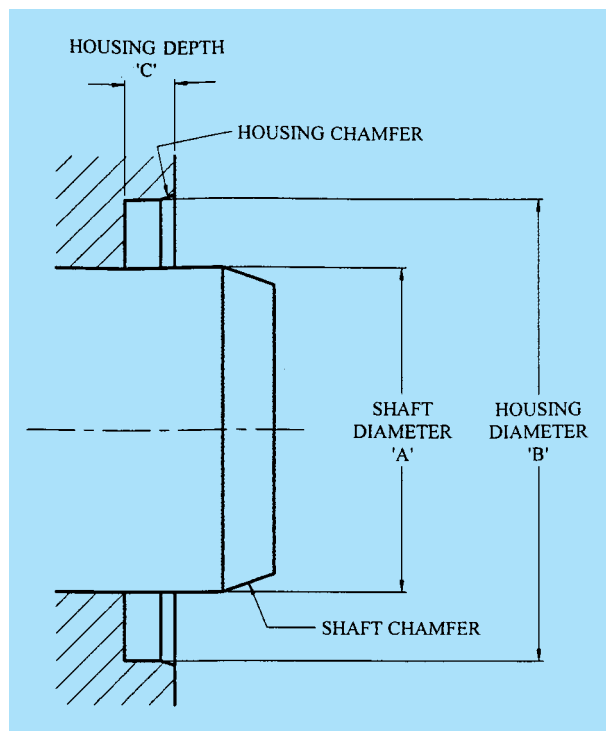

## JW Chart 104

### Walkersele® M6/D6 — inch sizes

Shaft Dia A	Housing Dia B	Housing Depth C	JW Part No.	JW Order Code
2	3	7/16	104-200	WG-050507
2 1/8	3 1/8	7/16	104-212	WG-05054X
2 1/4	3 1/4	7/16	104-225	WG-050574
2 3/8	3 3/8	7/16	104-237	WG-050604
2 1/2	3 1/2	7/16	104-250	WG-050639
2 3/4	4	1/2	104-275	WG-050701
3	4 1/4	1/2	104-300	WG-050760
3 1/4	4 1/2	1/2	104-325	WG-050833
3 1/2	4 3/4	1/2	104-350	WG-050892
3 3/4	5	1/2	104-375	WG-050957
4	5 1/4	1/2	104-400	WG-051015
4 1/4	5 3/4	5/8	104-425	WG-051074
4 1/2	6	5/8	104-450	WG-051147
4 3/4	6 1/4	5/8	104-475	WG-051201
5	6 1/2	5/8	104-500	WG-051279
5 1/4	6 3/4	5/8	104-525	WG-051333
5 1/2	7	5/8	104-550	WG-051392
5 3/4	7 1/4	5/8	104-575	WG-051465
6	7 1/2	5/8	104-600	WG-05152X
6 1/4	7 3/4	5/8	104-625	WG-051589
6 1/2	8	5/8	104-650	WG-051651
6 3/4	8 1/4	5/8	104-675	WG-051716
7	8 1/2	5/8	104-700	WG-051775
7 1/2	9	5/8	104-750	WG-051902
8	9 1/2	5/8	104-800	WG-052038
8 1/2	10	5/8	104-850	WG-05216X
9	10 1/2	5/8	104-900	WG-052283
9 1/2	11	5/8	104-950	WG-052410
10	11 1/2	5/8	104-1000	WG-052542
10 1/2	12 1/4	3/4	104-1050	WG-052666
11	12 3/4	3/4	104-1100	WG-052798
11 1/2	13 1/4	3/4	104-1150	WG-052925
12	13 3/4	3/4	104-1200	WG-053042
13	14 3/4	3/4	104-1300	WG-053301
14	15 3/4	3/4	104-1400	WG-053557
15	16 3/4	3/4	104-1500	WG-053816

All dimensions in inches

## Walkersele® M6/D6 standard range

**JW Chart 105**  
Walkersele® M6/D6 — metric sizes

Shaft Dia A	Housing Dia B	Housing Depth C	JW Part No.	JW Order Code
50	75	11	105-50	WG-060502
55	80	11	105-55	WG-060553
60	85	11	105-60	WG-06060X
65	90	11	105-65	WG-060650
70	102	12.5	105-70	WG-060707
75	107	12.5	105-75	WG-060758
80	112	12.5	105-80	WG-060804
85	117	12.5	105-85	WG-060855
90	122	12.5	105-90	WG-060901
95	127	12.5	105-95	WG-060952
100	132	12.5	105-100	WG-061002
105	145	16	105-105	WG-061053
110	150	16	105-110	WG-06110X
115	155	16	105-115	WG-061150
120	160	16	105-120	WG-061207
125	165	16	105-125	WG-061258
130	170	16	105-130	WG-061304
135	175	16	105-135	WG-061355
140	180	16	105-140	WG-061401
145	185	16	105-145	WG-061452
150	190	16	105-150	WG-061509
160	200	16	105-160	WG-061606
170	210	16	105-170	WG-061703
180	220	16	105-180	WG-061800
190	230	16	105-190	WG-061908
200	240	16	105-200	WG-062009
210	250	16	105-210	WG-062106
220	260	16	105-220	WG-062203
230	270	16	105-230	WG-062300
240	280	16	105-240	WG-062408
250	290	16	105-250	WG-062505
260	304	20	105-260	WG-062602
270	314	20	105-270	WG-06270X
280	324	20	105-280	WG-062807
290	334	20	105-290	WG-062904
300	344	20	105-300	WG-063005
310	354	20	105-310	WG-063102
320	364	20	105-320	WG-06320X
330	374	20	105-330	WG-063307
340	384	20	105-340	WG-063404
350	394	20	105-350	WG-063501
360	404	20	105-360	WG-063609
370	414	20	105-370	WG-063706
380	424	20	105-380	WG-063803
390	434	20	105-390	WG-063900
400	444	20	105-400	WG-064001
420	470	22	105-420	WG-064206

**JW Chart 105**  
Walkersele® M6/D6 — metric sizes (continued)

Shaft Dia A	Housing Dia B	Housing Depth C	JW Part No.	JW Order Code
440	490	22	105-440	WG-064400
460	510	22	105-460	WG-064605
480	530	22	105-480	WG-06480X
500	550	22	105-500	WG-065008

All dimensions in mm

**JW Chart 376**  
Walkersele® M6/D6/M — to DIN 3760/ (BS) ISO 6194-1

	Shaft Dia A	Housing Dia B	Housing Depth C	JW Part No.	JW Order Code
*	62	85	10	376-062085	WG-040609
*	62	90	10	376-062090	WG-040625
*	63	85	10	376-063085	WG-040633
*	63	90	10	376-063090	WG-040641
	65	85	10	376-065085	WG-04065X
	65	90	10	376-065090	WG-040668
*	65	100	10	376-065100	WG-040676
*	68	90	10	376-068090	WG-040684
*	68	100	10	376-068100	WG-040692
	70	90	10	376-070090	WG-040706
	70	95	10	376-070095	WG-040714
*	70	100	10	376-070100	WG-040722
*	72	95	10	376-072095	WG-040730
*	72	100	10	376-072100	WG-040749
	75	95	10	376-075095	WG-040765
	75	100	10	376-075100	WG-040757
*	78	100	10	376-078100	WG-040781
	80	100	10	376-080100	WG-040803
	80	110	10	376-080110	WG-040811
	85	110	12	376-085110	WG-040854
	85	120	12	376-085120	WG-040862
	90	110	12	376-090110	WG-040889
	90	120	12	376-090120	WG-040900
	95	120	12	376-095120	WG-040951
	95	125	12	376-095125	WG-04096X
	100	120	12	376-100120	WG-040986
	100	125	12	376-100125	WG-041001
	100	130	12	376-100130	WG-041028
	105	130	12	376-105130	WG-041052
*	105	140	12	376-105140	WG-041060
	110	130	12	376-110130	WG-041109
	110	140	12	376-110140	WG-041117
	115	140	12	376-115140	WG-04115X
*	115	150	12	376-115150	WG-041168

All dimensions in mm (*continued overleaf*)

# Walkersele® M6/D6 standard range

**JW Chart 376 (continued)**

**Walkersele® M6/D6/M — to DIN 3760/ (BS) ISO 6194-1**

	Shaft Dia A	Housing Dia B	Housing Depth C	JW Part No.	JW Order Code
	120	150	12	376-120150	WG-041206
*	120	160	12	376-120160	WG-041222
	125	150	12	376-125150	WG-041249
*	125	160	12	376-125160	WG-041257
	130	160	12	376-130160	WG-041303
*	130	170	12	376-130170	WG-04132X
	135	170	12	376-135170	WG-041354
	140	170	15	376-140170	WG-041400
	145	175	15	376-145175	WG-041451
	150	180	15	376-150180	WG-041508
	160	190	15	376-160190	WG-041605
	170	200	15	376-170200	WG-041702
	180	210	15	376-180210	WG-04180X
	190	220	15	376-190220	WG-041907
	200	230	15	376-200230	WG-042008
	210	240	15	376-210240	WG-042105
	220	250	15	376-220250	WG-042202
	230	260	15	376-230260	WG-04230X
	240	270	15	376-240270	WG-042407
	250	280	15	376-250280	WG-042504
	260	300	20	376-260300	WG-042601
	280	320	20	376-280320	WG-042806
	300	340	20	376-300340	WG-043004
	320	360	20	376-320360	WG-043209
	340	380	20	376-340380	WG-043403
	360	400	20	376-360400	WG-043608
	380	420	20	376-380420	WG-043802
	400	440	20	376-400440	WG-044000
	420	460	20	376-420460	WG-044205
	440	480	20	376-440480	WG-04440X
	460	500	20	376-460500	WG-044604
	480	520	20	376-480520	WG-044809
	500	540	20	376-500540	WG-045007

All dimensions in mm

\* These sizes no longer appear in the standards quoted.

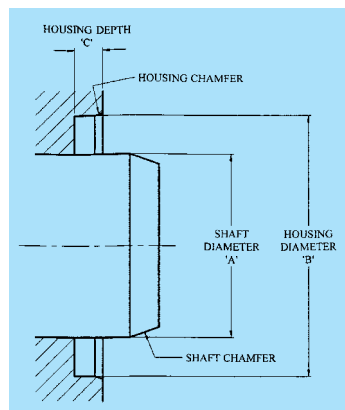

## Walkersele® success

### Side thrusters repairs

Swift action by James Walker and Blohm + Voss Repair ensured that the Queen Mary 2 cruise liner set sail on time after 11 days of classification work, painting and plant overhaul at Hamburg.



Four 220mm Walkersele M1/D7 seals were identified, precision moulded in the UK, and delivered to Hamburg in just two days to complete unscheduled work on the ship's starboard bow thrusters.

## Walkersele® success

### Tunnel boring in Australia

Walkersele® TBMS tunnel boring machine seals protected the cutting face bearings from sand and rock spoil on the 11m diameter machine that cut 6km of the fast-track Airport Link railway line beneath Sydney, Australia.

James Walker supplied the seals to the TBM's German manufacturer, Herrenknecht GmbH.



# Walkersele® housings

## Housing sizes — Walkersele® D6 design

For guidance purposes, our recommended housing sizes for given shaft diameters are:

Walkersele® D6 seals with retaining plates (All materials <b>except</b> M6 & M8)							
Shaft diameter 'A'				Nominal housing sizes			
				Depth 'C'		Section 'D'	
mm		inch		mm	inch	mm	inch
>	≤	>	≤				
-	35	-	1 3/8	10	3/8	11	7/16
35	65	1 3/8	2 1/2	11	7/16	12.5	1/2
65	100	2 1/2	4	12.5	1/2	16	5/8
100	250	4	10	16	5/8	20	3/4
250	400	10	16	20	3/4	22	7/8
400	600	16	24	22	7/8	25	1
600	-	24	-	25	1	32	1 1/4

## Housing sizes — Walkersele® D7 design

For guidance purposes our recommended housing sizes for given shaft diameters are:

Walkersele® D7 seals with retaining plates (All materials <b>except</b> M6 & M8)							
Shaft diameter 'A'				Nominal housing sizes			
				Depth 'C'		Section 'D'	
mm		inch		mm	inch	mm	inch
>	≤	>	≤				
30	100	1.18	3.94	15	0.591	17.5	0.689
100	250	3.94	9.84	16	0.630	20	0.787
250	400	9.84	15.75	20	0.787	22	0.866
400	600	15.75	23.62	22	0.866	25	0.984
600	-	23.62	-	25	0.984	32	1.260

Walkersele® D6 self-retaining seals (Materials M6* & M8)							
Shaft diameter 'A'				Nominal housing sizes			
				Depth 'C'		Section 'D'	
mm		inch		mm	inch	mm	inch
>	≤	>	≤				
-	65	-	2 1/2	10	3/8	10	3/8
65	100	2 1/2	4	12.5	1/2	12.5	1/2
100	250	4	10	15	5/8	15	5/8
250	400	10	16	20	3/4	20	3/4
400	600	16	24	22	7/8	22	7/8
600	900	24	35 1/2	25	1	25	1

Walkersele® D7 self-retaining seals (Materials M6 & M8)							
Shaft diameter 'A'				Nominal housing sizes			
				Depth 'C'		Section 'D'	
mm		inch		mm	inch	mm	inch
>	≤	>	≤				
30	250	1.18	9.84	15	0.591	15	0.591
250	330	9.84	12.99	16	0.630	17.5	0.689
330	450	12.99	17.72	20	0.787	20	0.787
450	600	17.72	23.62	22	0.866	25	0.984
600	-	23.62	-	25	0.984	30	1.181

\*Note that M6 standard seals to charts 104, 105 and 376 will not necessarily conform to these recommendations, so please use dimensions shown on those charts on pages 22-24.

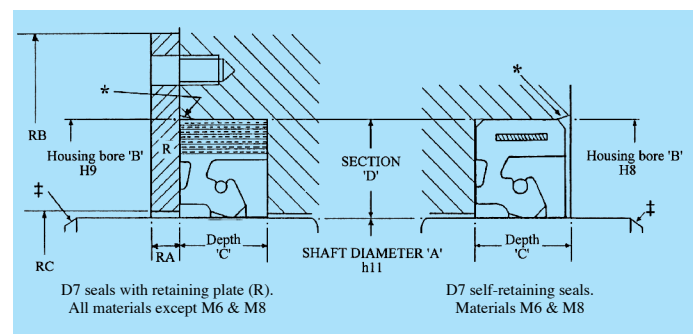
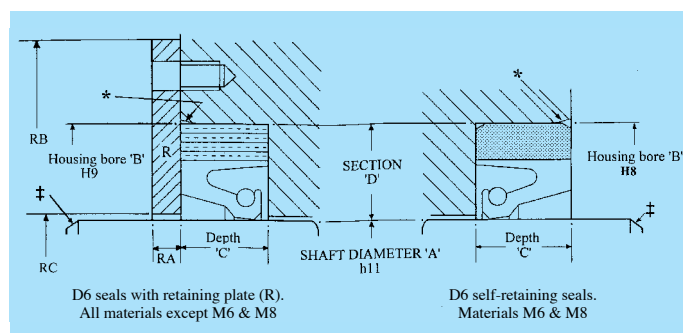

# Walkersele® housings

## Housing tolerances — D6 & D7 designs

Shaft housing diameter tolerances based on BS EN 20286-2, ISO 286-2. We recommend h11 be used to allow for shaft reconditioning.

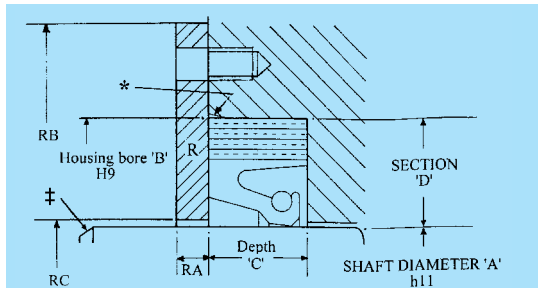

Seals with retaining plate 'R'  
(ie, all materials **except** M6 & M8)

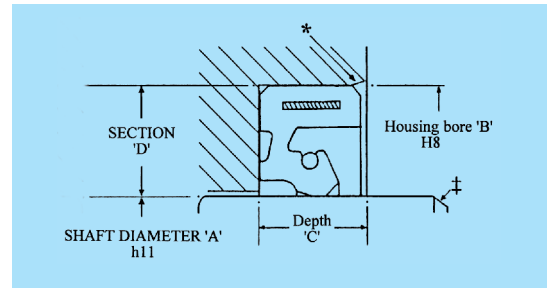

Self-retaining seals  
(ie, materials M6 & M8)

Housing depth 'C' tolerance limits		
	mm	inch
Single seals	± 0.1	± 0.004
Double seals	+ 0.2	+ 0.008
	- 0	- 0

## ± Shaft chamfers — D6 & D7 designs

± Shaft chamfers					
mm			inch		
Shaft diameter 'A'		Chamfer minimum axial depth	Shaft diameter 'A'		Chamfer minimum axial depth
>	≤		>	≤	
3	50	8 x 15°	0.12	1.97	5/16 x 15°
50	250	10 x 15°	1.97	9.85	3/8 x 15°
250	800	15 x 15°	9.85	31.5	9/16 x 15°
800	-	20 x 15°	31.5	-	3/4 x 15°

## \*Housing chamfers — D6 & D7 designs

A chamfer should be provided at the entrance to the housing to facilitate assembly (particularly for M6 and M8 Walkerseles). Where the nominal housing depth is equal to the seal depth, the chamfer dimensions should not exceed 1mm x 30° for seals up to and including 10mm deep, or 2mm x 30° for seals over 10mm deep (0.040 inch x 30° for seals up to and including 3/8 inch deep, or 0.080 inch x 30° for seals over 3/8 inch deep).

## Retaining plate (R) dimensions — D6 & D7 designs

Nominal shaft diameter 'A' (mm)		Minimum plate thickness 'RA' (mm)		Outside diameter 'RB' [minimum] (mm)	Inside diameter 'RC' [maximum] (mm)		Bolting requirements		
>	≤	Single seals	Double seals		D6 design	D7 design	Size	Number of bolts	PCD (mm)
-	35	3	4.5	B + 28	A + 0.75C	A + 3	M5	4	B + 13
35	65	4	6	B + 30	A + 0.75C	A + 3	M5	6	B + 13
65	100	5	7.5	B + 43	A + 0.75C	A + 3	M8	6	B + 20
100	250	7	10.5	B + 45	A + 0.75C	A + 4	M8	8	B + 20
250	400	8	12	B + 56	A + 0.75C	A + 4	M10	8	B + 24
400	600	10	15	B + 65	A + 0.75C	A + 4	M12	12	B + 30
600	900	12.5	18.8	B + 76	A + 0.75C	A + 5	M14	16	B + 34
900	1200	12.5	22.5	B + 76	A + 0.75C	A + 5	M14	20	B + 34

Note that with **Walkersele® D7** a retaining plate should cover the full base width of the seal to support the heel (necessary for resisting fluid pressures) especially when an otherwise 'self-retaining' seal is fitted facing outwards.

## Walkersele® installation techniques

## General information

**Important notice: Do not attempt to re-install a Walkersele® once it has been removed from its housing. To ensure long-term efficient operation, *always* fit a new Walkersele.**

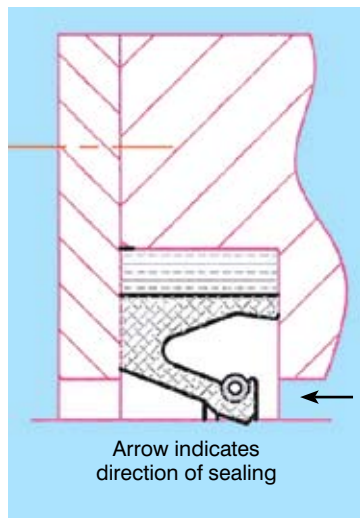

- 1) The groove formed between the lip seal and back should normally face the direction to be sealed.
- 2) With an endless-seal, a lead-in should be provided at the ends of shafts, roll necks, abutment rings, etc, over which the seal has to pass, to avoid damaging the seal lips (see page 26).
- 3) Thoroughly clean the seal housing and shaft. Wipe the seal with a clean cloth to remove any dust, etc, accumulated during storage.

4) Apply a smear of lubricant to the seal lip and shaft immediately prior to installation. (Note lubricant/chemical compatibilities on pages 7 to 9 for Walkersele® materials.)

5) When seal housings are detachable and in halves, we recommend that (where possible) these halves be bolted together before installing the seal.

6) Use the correct size retaining plates, where applicable (see page 26). Thin retaining plates should be avoided, as they tend to distort when bolted and compress the seal unevenly.

7) Jointing compounds should NOT be used on the seal. They may, however, be carefully and thinly applied between the retaining plate and machine or housing face to prevent leakage under the retaining plate — particularly if the plate is fitted on the sealed fluid side. Care must be taken to avoid contamination or ingress of jointing compound into the seal area.

## Endless seals (except M6 &amp; M8)

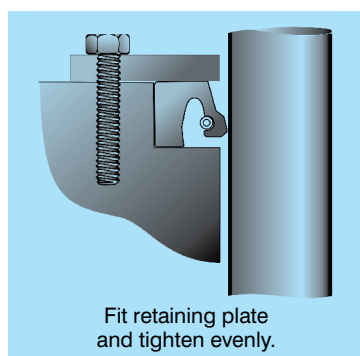

- 1) Flex the seal in hands to ensure an even distribution of spring tension.
- 2) Work the seal into the housing by hand and press it firmly against the bottom of the housing.
- 3) Apply retaining plate and bolt up evenly until it is hard against seal housing face.

## Endless seals M6 &amp; M8 self-retaining

1) Liberally lubricate the seal outside diameter with soapy water or soft grease. (Note lubricant/chemical compatibilities on pages 7 to 9 for Walkersele® materials.)

2) Enter seal into housing — to almost full depth of seal — for as much of the circumference as possible. This should leave about one-sixth of the seal to be manipulated.

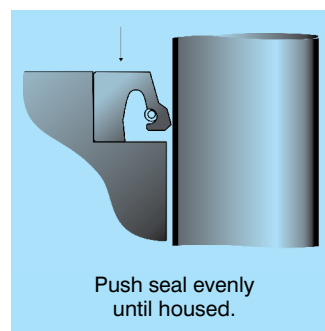

3) Gradually work the un-entered part of seal into the housing by inward and downward hand pressure. This should be sufficient for seals up to 450mm (18 in) diameter.

4) Above 450mm (18 in) diameter, the last portion of the seal should be looped so it curves away from the housing.

5) The last portion of seal circumference is then urged towards the housing bore by hand pressure until it forms a circle.

6) Press or tap the seal evenly into its final axial location, and replace the shaft.

## Split seals (not applicable to M6 &amp; M8)



1) Remove spring from seal (where applicable) and unscrew spring at the join.

2) Pass spring around shaft and, holding one end in each hand, twist one end a few turns as if 'unscrewing'. Now bring spring ends together and screw up the join.

3) Flex seal ends outwards to counteract any curl-in that has occurred during transit or storage (Curl-in can cause leakage).

4) Pass the seal around the shaft — ensuring the lip points the correct direction for sealing action required — then lift the spring into the groove in the seal lip.

5) Ensure the two seal ends mate perfectly. With split at the top, enter the seal evenly into the housing and press it firmly to the housing bottom.

6) When two seals are fitted together, the joins should be staggered at about 30° on each side of top dead centre.

7) Apply retaining plate and bolt up evenly until it is hard against the seal housing face.

## Walkersele® installation techniques

### Fitting self-retaining lip seals (eg, M6 & M8) in blind housing

- 1) The groove formed between the seal lip and back should normally face the direction to be sealed.
- 2) Thoroughly clean the seal housing and shaft. Wipe the seal with a clean cloth to remove any dust, etc, accumulated during storage.
- 3) Apply a smear of lubricant to the seal lip. A small amount of bearing oil is suitable for this (Do NOT use jointing compound on the seal).
- 4) Liberally lubricate the seal outside diameter with soapy water. This ensures that the outside diameter interference becomes evenly distributed, and eases the fitting process.
- 5) Enter the seal into the housing for as much of the circumference as possible. This should leave about 20% of the seal to be manipulated into position. The last portion of the seal circumference should be looped so it curves away from the housing.
- 6) Using only hand pressure, urge the last portion of the seal circumference towards the housing bore until it forms a circle.
- 7) Ensure the seal is fully seated against the housing bore. If necessary, press or tap the seal evenly into its final axial position. Do NOT use any sharp implements that may damage the seal. A flat fitting tool with rounded edges should be used, and then applied only to the outer diameter of the seal.
- 8) Ensure the seal is fully located in the base of the housing around its entire circumference, as any unevenness will affect seal performance.
- 9) For **second seal**, repeat steps 3 to 8, ensuring it is firmly seated against the first seal.
- 10) Replace seal housing and bolt up evenly until it is hard against the bearing housing face.

### Walkersele® OSJ-2 On-Site Joining



Accurately follow the straight forward procedure as shown during official training session with James Walker personnel. Also, refer to instructions provided with each OSJ-2 kit (see pages 14-15).

### Walkersele® success

#### **Propulsion shafts**

*All M-Class frigates of the Dutch Royal Navy now have Walkerseles installed on their propulsion shafts, following a technical review of the support bearing seals.*



*The arrangement is based on two Walkersele lip seals with James Walker's patented OSJ® (On-Site Joining) technique, plus an automatic lubricant dispenser and new bearing cover. It replaces a labyrinth system that scored the propulsion shaft.*

### Walkersele® success

#### **Tidal power**

*The world's first commercially-viable tidal turbine operates in Northern Ireland — with rotor blade bearings protected by Walkersele radial lip seals.*

*The prototype SeaGen turbine was installed in Strangford Lough in May 2008 and supplies power to Northern Ireland Electricity.*

*Each of the turbine's dual 16m diameter rotors has two Walkerseles fitted back-to-back to prevent sea water entering the main bearings and lubricant escaping.*



*Photo by courtesy of Dr I J Stevenson.*

## Operational considerations

### Multi-seal configurations

In the vast majority of Walkersele® applications a single seal will provide the level of protection required.

On occasions, however, two or more seals in various configurations are necessary to ensure long-term protection under particularly arduous operating conditions. The following are a few examples:

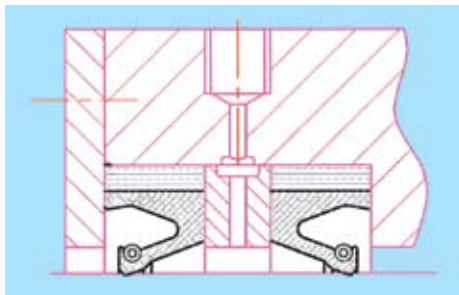

*Back-to-back configuration for two-way sealing. Used to prevent loss of bearing lubricant and also prevent ingress of external contaminants.*

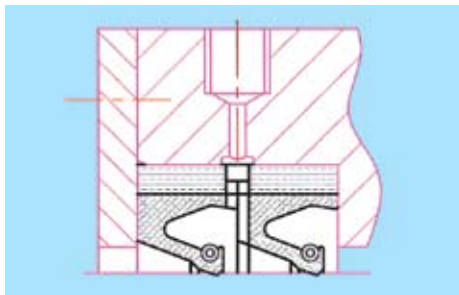

*Inward-facing series configuration for extra protection. Typically used to prevent bearing lubricant reaching a product where contamination is not permitted.*

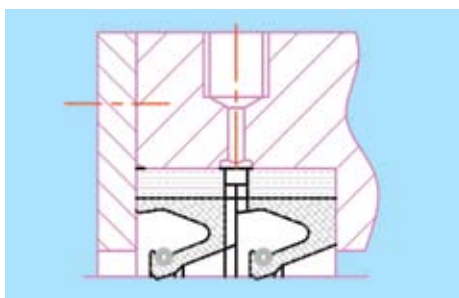

*Outward-facing series configuration for extra protection. Typically used to prevent aggressive media reaching the bearings.*

Please note that Walkersele D7 seals need heel support, even in the back-to-back configuration.

We recommend you discuss multi-seal configurations with our Technical Support Team to determine the optimum sealing system for your application.

### Seal lubrication

The sealing lip of a Walkersele® will usually have adequate lubrication for long-life operation when:

- A single seal is fitted to retain lubricant within a bearing assembly.
- Two seals are housed together, with bearing lubricant acting on one and, typically, rolling fluid or coolant acting on the other.

However, when more than two seals — and sometimes only two, on arduous duties — are housed together, the danger exists that one or more will run dry unless lubricated from an exterior source. To accomplish this:

- Ensure that the chock arrangement allows lubricant to pass through freely to the position where the seals meet.
- Install standard Walkerseles with an inter-seal lantern ring/s between them that is ported to allow lubricant access to the inter-seal shaft area and the seal lips (see diagram below). We can supply suitable lantern rings in metal or plastic; please contact our Technical Support Team.

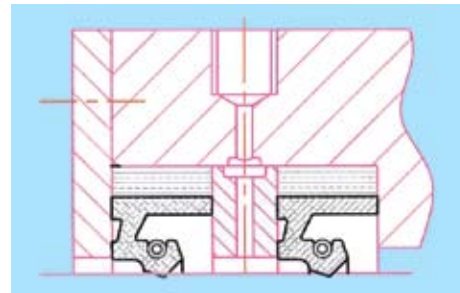

*Standard seals with lantern ring (preferred option for inter-seal lubrication).*

Where there is insufficient axial space to incorporate a lantern ring:

- Machine an annular groove in the back of the housing to connect with the drilled lubricant hole.
- Fit Walkerseles that have radial ports in the base (available to order) that allow lubricant to pass to the lip (see diagram below).
- When it is impractical to machine an annular groove in the housing, the groove can be incorporated in the seal backs (available to order). For this the seal section must be a minimum of 12.5mm (½ inch) in width.
- In both these cases, please discuss your applications with our Technical Support Team before metal cutting. We may be able to suggest a better alternative.

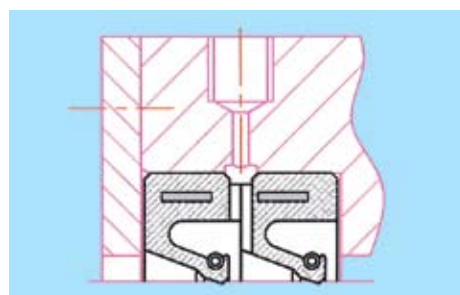

*Housing with annular groove, plus seals with radial ports.*

# Operational considerations

## Eccentricity limits

A worn or misaligned shaft/bearing assembly requires lip seals that can 'follow' the shaft by the amount it is offset, or wobbles.

The highly flexible lips of many Walkersele® material/design combinations will cater for certain levels of eccentricity, dependent on seal diameter and shaft surface speed.

The following eccentricity graphs apply only to 'endless' Walkerseles and **Walkersele OSJ-2** applications (see pages 14-15) as split-type seals may tend to open at the abutted joint when shaft dynamics are severe. Please discuss with our Technical Support Team any applications that involve known eccentricity.

Limits of eccentricity: endless M1/D6 Walkersele®

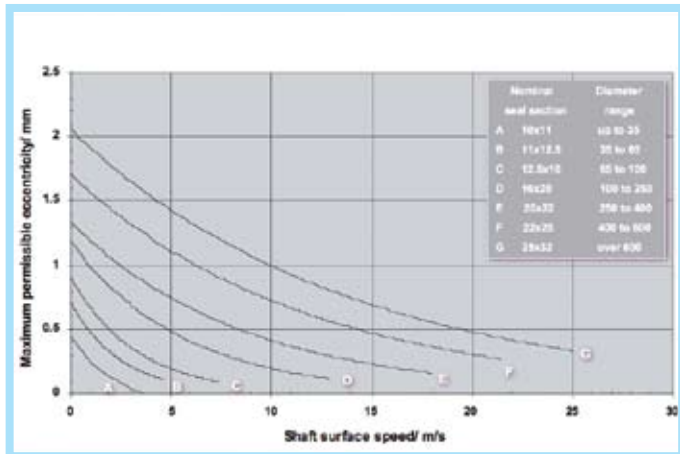

Limits of eccentricity: endless M1/D7 Walkersele®

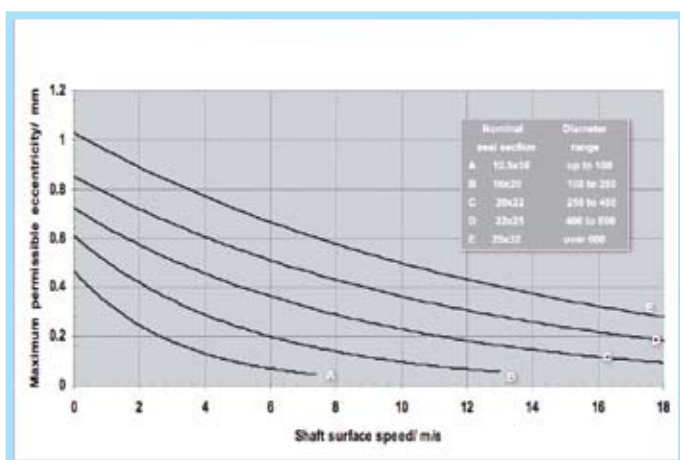

## Lip support plates

A lip support plate is typically used with a Walkersele® D6 profile to increase the pressure differential rating to 2bar (29psi).

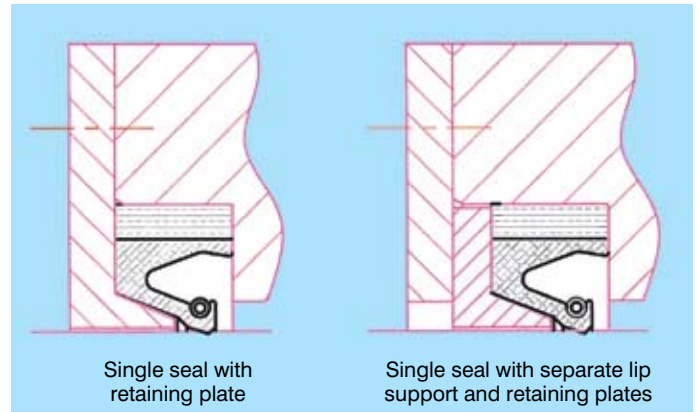

This arrangement is often preferred over a Walkersele D7 profile (rated at 4bar/58psi) when:

- The lower lip loading and higher sealing efficiency of the D6 profile is required.
- Housing space is not limited, allowing both the Walkersele D6 plus lip support plate to be accommodated.
- There is no danger that any eccentricity will permit the lip support plate to make contact with the shaft.

Lip support plates are supplied to order. Our preferred materials are phosphor bronze, brass, aluminium, mild steel, and stainless steel.

## Shaft surfaces

The sealing area of a shaft should have a fine ground finish of 0.2 to 0.8µm Ra (8 - 32µ inch CLA) for the majority of Walkersele® applications.

Where higher speeds are involved — ie, in excess of 8m/s (1575fpm) — we recommend an improved finish of 0.2 to 0.4µm Ra (8 - 16µ inch CLA).

In all cases, the shaft sealing area must be plunge ground and free from machining marks, dents, burrs, scratches and single-pass grinding wetness patterns.

Providing that lubrication is adequate and free from abrasive content, unhardened mild steel shafts will generally give satisfactory results under normal operating conditions. However, a harder shaft material is recommended for applications where lubrication is poor, abrasives are present, or speed and pressure conditions are arduous.

## Operational considerations

### Shaft hardness

A shaft hardness of 40-50 HRC (Rockwell C) is generally acceptable for long-term Walkersele® operation. However, where shaft wear has to be kept to the absolute minimum — particularly with high speed, abrasive or pressurised applications — a minimum shaft hardness of 60 HRC is recommended.

When necessary, we recommend that nitrogen case hardening (nitriding) treatment be applied to certain types of steel shaft or shaft sleeve to provide about 0.5mm (0.02 inch) depth of hardened surface to around 1100 VHN (68 HRC).

Other methods of hardening the shaft surface include ceramic plasma coating, or the application of thin dense chrome. For specific recommendations please contact our Technical Support Team.

### Ceramic shafts

Albeit tough and resilient, ceramic shafts are usually abrasive and thermally insulating. This means that the higher temperature grades of Walkersele® material, or those with better heat dissipation qualities, should be used.

Please consult our Technical Support Team for recommendations on such applications.

### Housing surfaces

A fine machined finish, free of dents and scratches, is recommended for the housing bore.

All Walkerseles (apart from Fluolion® PTFE versions) have elastomeric or elastomer-proofed fabric backs and are very unlikely to damage the housings during installation, operation or removal. Metal cased seals, however, can present problems that possibly lead to housing damage during installation and/or removal when the fit is tight.

The elastomeric back of a Walkersele® presents an efficient sealing surface to the housing that prevents the by-pass of bearing lubricant or external fluid media. Walkerseles are designed to be a compression fit in their housings; therefore circumferential compression on the outside of the seal, or axial compression on the depth of the seal for retained units, provide for complete fluid sealing around the back.

The flexibility of Walkersele backs also gives them greater tolerance to slight housing imperfections — eg, ovality, damage and wear — than is possible with a metal cased seal.

### Walkersele® storage

Like other precision manufactured fluid seals, Walkerseles should be stored in a cool, dark and dry place. They should be laid flat — NOT tied together with string or wire, or suspended from hooks, as this can impair the sealing efficiency of their lips.

Please refer to BS ISO 2230 *Rubber products — Guidelines for storage*.

### Walkersele® power consumption

Under certain operational conditions, it may be necessary to consider the comparative frictional power consumption of Walkersele® radial lip seals as manufactured in different elastomers.

The following graph shows curves of *Power consumption v Running time* for four specific lip materials.

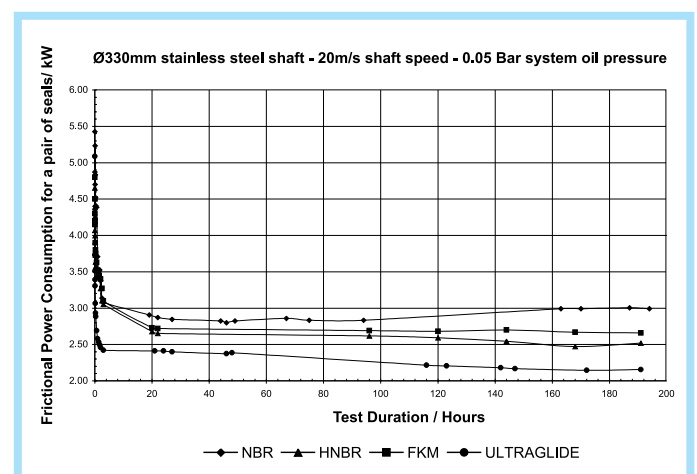

Comparative frictional power consumption for pairs of Walkersele® D6 manufactured in four different materials.

## Other rotary seal types

In addition to our Walkersele® range of lip seals, we also supply other types of well-proven seal for rotary shaft applications.

### End face seals or V-rings

These flexible lip seals fit on a shaft and seal axially against a counter face — such as a roller bearing face, shaft collar or thrust washer.

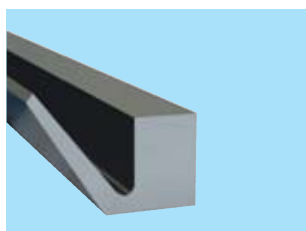

V-ring Type 41

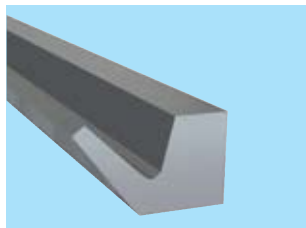

V-ring Type 78

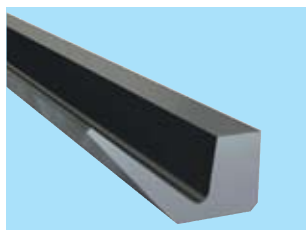

V-ring Type 99

#### Special features

- Well-proven designs.
- Reliable sealing against splash grease, oil and water, as well as dust and dirt.
- Low friction running.
- No running-in period required.

#### Availability

**Standard seals:** All sizes and designs of V-ring are readily available in commercial grades of elastomer; the standard grade being nitrile (NBR) of 70 IRHD (70 Shore A).

**Non-standard seals:** End face seals/V-rings to non-standard sizes, or in high performance elastomers to match specific duties, are in-house manufactured to order.

Please contact us to check mould availability. Where we have a suitable tool, your seal will be supplied on short delivery time without tooling charges. New tools are swiftly made in-house. In these cases a tooling charge will be applied.

### Metal cased lip seals

We supply a range of competitively priced seals to ISO 6194 in over 500 combinations of design and size, in standard materials.



#### Materials

These seals are supplied with nitrile (NBR) lips as standard, with other elastomers available to suit specific working conditions. The cases and spring materials are supplied in carbon steel as standard, with stainless steel available on request.

#### Availability

All standard sizes and designs are readily supplied. Please contact us before placing your order, especially if non-standard types are required.

## James Walker in action

### Customer support at every level

When you select Walkersele®, or one of our many other sealing products, you immediately get the full expertise of James Walker on your side — wherever you may be in the world.

We aim to supply you with the very best:

- Customer service
- Technical support
- Fluid sealing products
- Delivery
- After sales service.



Our high technology Customer Support Centre leads the fluid sealing industry with its service to tens of thousands of customers worldwide.

On-site technical advice comes from our highly experienced field engineers and industry sector specialists — backed by the materials technologists, chemists, research and development engineers and test laboratory staff at James Walker Technology Centre. Together, they have the knowledge and technical facilities to solve virtually any fluid sealing problem for our customers.

User training is another important service we provide. Our specialists regularly host sessions to instruct plant engineers and designers in the selection and installation of our products. This service is backed by training films on free CD-ROMs.

### Worldwide network & supply

A close-knit network of James Walker companies and official distributors covers over 100 countries. This is supported by a secure web-based and highly developed logistics operation to give you surety of supply for your JIT regimes, normal maintenance schedules, and any emergency breakdowns.

Our automated warehouses hold ten million sealing products ready for same day despatch. These include stocks of the most popular sizes of Walkersele® M1/D6 and M6/D6 that suit the vast majority of applications.



If we do not stock the seals you need, we can supply them within days — rather than weeks. This we achieve because we compound all our elastomers in-house and operate flexible manufacturing systems at our production plants.

When necessary, production time-scales can be reduced to just hours to help you bring a process line back into operation or enable a ship to continue its journey.

In addition, our Walkersele field engineers can bring the seals with them and help your maintenance staff to fit them correctly. This service is particularly valuable when a Walkersele OSJ-2 is installed and on-site joined for the first time at your plant.

### Production facilities

Our manufacturing plants for elastomeric seals are located in the UK, USA and Australia. These, together with other production facilities around the world, ensure we provide industries at all levels with top quality engineered solutions for their sealing problems.

In-house facilities include:

- Compression moulding to 2.2m (87 inch) diameter in a single operation — with one of the biggest presses for precision moulding in Europe.
- Compression vacuum moulding to 2.1m (83 inch) diameter in a single operation.
- Continuity moulding with no joins and unlimited diameter for certain profiles.
- Special mould-joining technique for producing elastomeric components to unlimited diameter.
- Injection moulding to 500mm (19.7 inch) diameter.
- Transfer moulding.
- CNC centre for machining elastomers and engineering plastics.
- Elastomer impregnation of fabrics and fibres for production of specialised composite materials.
- Batch compounding of over 300 elastomer grades with interlocked energy, time and temperature control for QA traceability.

## James Walker in action

### Quality standards

Our quality systems are third-party registered to BS EN ISO 9001:2000. We are also regularly assessed and quality approved by a wide range of industry bodies including multinational corporations, utilities and government organisations.



In addition, we hold test equipment for all relevant BS, ISO, ASA, API, ANSI, DIN, DTD and NATO standards. Certificates of conformity can be supplied on request, with packaging and labelling available to individual specifications.

We always select the best raw materials for each product, and use advanced manufacturing techniques with strict quality control and traceability at every stage — regardless of any release certificate requirements. Moreover, our compression, transfer and injection moulding techniques are used in an environment where cleanliness is paramount.

Our manufacturing process culminates in an exacting inspection procedure for the finished product. Stockholding and distribution facilities meet similar exacting standards.

Material Safety Data Sheets (MSDS) relating to all our products are available on request.

### Research & development

Our materials and product development programmes have continued unceasingly since the 1880s. They started when our founder, Scottish engineer James Walker, developed an innovative steam packing that proved vital to the success of a new generation of high-efficiency steam engines for powering mankind into the 20th century.

Our aim today is to raise performance parameters and provide fluid sealing products that give long-term reliable service in increasingly hostile and demanding industrial environments.



To help us meet these targets, in 2004 we opened our new Materials Technology Centre at Cockermouth in Cumbria, UK. This contains one of the world's most advanced elastomer research, test and prototyping facilities. It is also the home of our fluid sealing product design, development and test facilities.

Our technologists and laboratory staff deliver new materials, products and manufacturing techniques that improve the *best value* sealing efficiency of your existing plant — and will meet the demands of tomorrow's systems that are still at the design stage.



The objectives are a longer maintenance-free operating life, reduced installation time, improved sealing efficiency, plus the ability to work at higher speeds, greater pressures and extremes of temperature.

Features such as our innovative Walkersele<sup>®</sup> OSJ-2, Walkersele Ultraglide, Walkersele Aflas<sup>®</sup> and a multitude of custom-designed products prove the success of recent R&D programmes on rotary lip seals.

We also work on joint venture research projects with other organisations in the European Sealing Association — of which we are a founder member — and sponsor high-level research in partnership with world leading users of sealing technology.

In addition to our in-house test laboratories that verify the viability of our materials and seal designs, we regularly commission independent test houses across the world for third-party certification of our products to international and industry standards.

## Industry-wide applications

## Walkersele® applications

Our range of Walkersele® radial lip seals has earned an enviable reputation worldwide for sealing efficiency and long maintenance-free operation.

Here is a selection of the many sectors where plant and equipment operators rely on Walkersele's ability to keep the wheels of industry turning safely and reliably — year-in and year-out.

**Metallurgical sector**

- AGC capsules
- Casters
- Coating lines
- Cold mills
- Coil boxes & down coilers
- Coilers & reelers
- Extrusion presses
- Finishing mills
- Forging presses
- Hot rolling mills
- Overhead cranes — gearboxes
- Plate mills
- Strip mills
- Temper mills
- Universal mills — scale breakers, roughers, edgers, billet, bloom & slab.

**Mineral extraction & processing**

- Cement mills
- Conveyors
- Drag lines
- Mixers & grinders
- Rock crushers
- Rotary kilns
- Winding gear.

**Power generation**

- Coal pulverisers & ball mills
- Diesel plant
- Generator sets
- Hydroelectric plant — water turbines & dam gate bearings
- Steam turbines
- Wind turbines.

**Marine**

- Bow thrusters
- Bulkhead seals
- Crane drums
- Dredging plant
- Gearboxes & transmission systems
- Power plant
- Rudder posts
- Shaft bearings
- SRP swivel joints & shafts
- Stabilisers
- Stern glands.

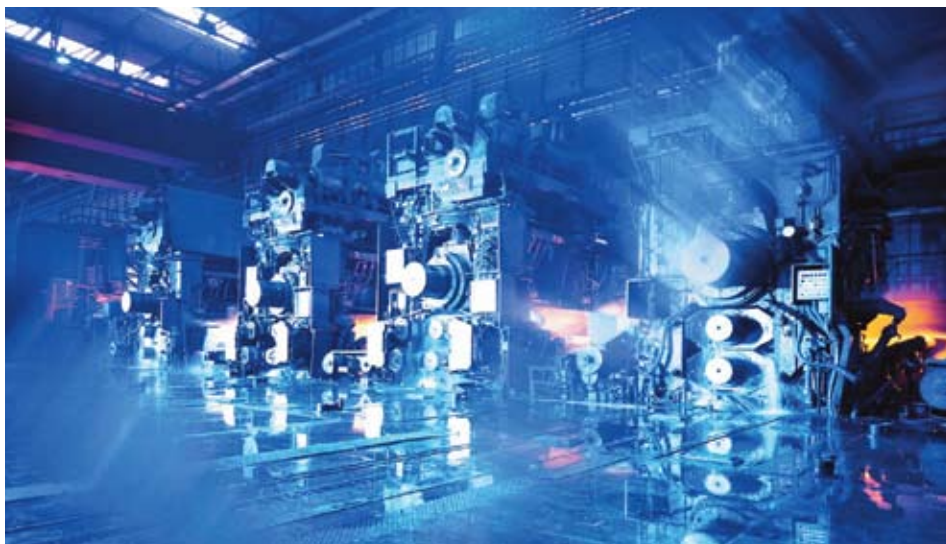

Photo courtesy of Siemens VAI

**Processing sector**

- Centrifuges
- Chemical pulping lines
- Dry cleaning machines
- Extractor drums
- Mixing vessels.

**Pulp & paper mills**

- Calenders
- Chippers
- Debarkers
- Digesters
- Dryers
- Felt rolls
- Head boxes
- Press rolls
- Screening
- Section rolls
- Washers.

**Food & pharmaceuticals**

- Conveyors
- Cutters
- Grinders
- Mixers.

**Construction**

- Tunnel boring machines.

**Land transport**

- Rail traction systems.

**Manufacturing industry**

- Machine tools.

**Water industry**

- Filter beds.

## Trademark acknowledgements

James Walker acknowledges the following trademarks as mentioned in this document. All other names bearing the ® symbol are registered trademarks of James Walker.

Aflas® Asahi Glass  
Inconel® Special Metals Corporation

## General information

**Health warning:** If PTFE or fluoroelastomer (eg, FKM, FFKM, FEPM) products are heated to elevated temperatures, fumes will be produced which may give unpleasant effects, if inhaled. Whilst some fumes are emitted below 250°C from fluoroelastomers or below 300°C from PTFE, the effect at these temperatures is negligible. Care should be taken to avoid contaminating tobacco with particles of PTFE or fluoroelastomer, or with PTFE dispersion, which may remain on hands or clothing. Material Safety Data Sheets (MSDS) are available on request.

Information in this publication and otherwise supplied to users is based on our general experience and is given in good faith, but because of factors which are outside our knowledge and control and affect the use of products, no warranty is given or is to be implied with respect to such information. Specifications are subject to change without notice. Statements of operating limits quoted in this publication are not an indication that these values can be applied.

## James Walker companies worldwide

### James Walker & Co

Tel: +44 (0)1270 536000  
Fax: +44 (0)1270 536100  
Email: [csc@jameswalker.biz](mailto:csc@jameswalker.biz)

### James Walker Australia

Tel: +61 (0)2 9644 9755  
Fax: +61 (0)2 9645 2009  
Email: [jwadmin@jameswalker.com.au](mailto:jwadmin@jameswalker.com.au)

### James Walker Benelux

(Belgium)  
Tel: +32 3 820 7900  
Fax: +32 3 828 5484  
Email: [sales.be@jameswalker.biz](mailto:sales.be@jameswalker.biz)  
(Netherlands)  
Tel: +31 (0)186 633111  
Fax: +31 (0)186 633110  
Email: [sales.nl@jameswalker.biz](mailto:sales.nl@jameswalker.biz)

### James Walker China

Tel: +86 21 6876 9351  
Fax: +86 21 6876 9352  
Email: [info.cn@jameswalker.biz](mailto:info.cn@jameswalker.biz)

### James Walker Deutschland

Tel: +49 (0)40 386 0810  
Fax: +49 (0)40 389 3230  
Email: [info@jameswalker.de](mailto:info@jameswalker.de)

### James Walker France

Tel: +33 (0)437 497 480  
Fax: +33 (0)437 497 483  
Email: [headoffice.fr@jameswalker.biz](mailto:headoffice.fr@jameswalker.biz)

### James Walker Iberica

Tel: +34 94 447 0099  
Fax: +34 94 447 1077  
Email: [iberica@jameswalker.biz](mailto:iberica@jameswalker.biz)

### James Walker Ireland

Tel: +353 (0)21 432 3626  
Fax: +353 (0)21 432 3623  
Email: [sales.ie@jameswalker.biz](mailto:sales.ie@jameswalker.biz)

### James Walker Italiana

Tel: +39 02 257 8308  
Fax: +39 02 263 00487  
Email: [jameswalker@jameswalker.it](mailto:jameswalker@jameswalker.it)

### James Walker Mfg (USA)

Tel: +1 708 754 4020  
Fax: +1 708 754 4058  
Email: [sales.jwmfg.us@jameswalker.biz](mailto:sales.jwmfg.us@jameswalker.biz)

### James Walker New Zealand

Tel: +64 (0)9 272 1599  
Fax: +64 (0)9 272 3061  
Email: [sales@jameswalker.co.nz](mailto:sales@jameswalker.co.nz)

### James Walker Norge

Tel: +47 22 706800  
Fax: +47 22 706801  
Email: [firmapost@jameswalker.no](mailto:firmapost@jameswalker.no)

### James Walker Oil & Gas (USA)

Tel: +1 281 875 0002  
Fax: +1 281 875 0188  
Email: [oilandgas@jameswalker.biz](mailto:oilandgas@jameswalker.biz)

### James Walker Singapore

Tel: +65 6777 9896  
Fax: +65 6777 6102  
Email: [sales@jameswalker.com.sg](mailto:sales@jameswalker.com.sg)

### James Walker South Africa

Tel: +27 (0)31 205 6251/2/3  
Fax: +27 (0)31 205 6266  
Email: [info.za@jameswalker.biz](mailto:info.za@jameswalker.biz)

## James Walker & Co Ltd

Customer Support Centre  
1 Millennium Gate, Westmere Drive  
Crewe, Cheshire CW1 6AY, UK  
Tel: +44 (0)1270 536000  
Fax: +44 (0)1270 536100  
Email: [csc@jameswalker.biz](mailto:csc@jameswalker.biz)

[www.jameswalker.biz](http://www.jameswalker.biz)



CERTIFICATE No. FM 01269  
BS EN ISO 9001:2000