



## Redi-Rock™ Modular Walls



Water Management | Precast | Retaining Walls

# Welcome to Marshalls CPM

Marshalls CPM is a market leading manufacturer of precast concrete products with production facilities across the UK. The business is built on a solid reputation for delivering quality products and providing a first class service to every sector of the construction industry, fully supported by our experienced technical and engineering teams.

## Marshalls CPM / Redi-Rock™ Solution

Marshalls CPM's BBA approved Redi-Rock™ modular wall system is an ingenious, space saving solution for the retention of earth for a wide range of retaining, force protection, landscaping and flood protection applications. The 'big block system' has the appearance of natural stone and is versatile enough to achieve height without compromising on strength. Each one tonne block (1040 series) interlocks with the next and is dry laid, resulting in extremely fast installation times and cost saving.

## Marshalls CPM / Sustainability

Redi-Rock™ is manufactured from over 25% recycled materials to provide a sustainable solution for a wide variety of applications. Walls can be dismantled and relocated so if your project changes, you can disassemble and relocate – The ultimate sustainable solution with minimal maintenance required.

## Marshalls CPM / Approval

Marshalls CPM is the only manufacturer of Redi-Rock™ modular walling in the United Kingdom mainland as licensed by Redi-Rock International. The modular walling solution has BBA approval, C E Marking, approval from the Highway Authorities Product Approval Scheme (HAPAS) and is British Kitemarked by PAS 68 certification.

## Marshalls CPM / Customer Service

Here to help at every stage, the Redi-Rock™ modular walling system is a complete solution and we offer an extensive engineering, design and installation support service which includes a range of engineered design charts, calculations, BIM, free retaining wall engineering analysis software as well as:

- Project scheduling and management
- Full bespoke engineering service for unusual and problematic solutions
- Quality control at every stage
- Installation support or full installation available
- 120 year design life
- Full design service

Please call our Redi-Rock™ team to see if we can offer you a Redi-Rock™ solution

Tel: 01179 814500 / Email [redi-rock@marshalls.co.uk](mailto:redi-rock@marshalls.co.uk) / Web [www.cpm-group.com/www.ukretainingwalls.co.uk](http://www.cpm-group.com/www.ukretainingwalls.co.uk)

# Product Index

---

<b>02-03</b>	<b>Welcome to Marshalls CPM / Product Index</b>
<b>04-05</b>	<b>What is Redi-Rock™ / Freedom of Choice</b>
<b>06-07</b>	<b>Key Benefits / Engineering and Design</b>
<b>08-09</b>	<b>Professional Services / Accreditation and Approvals</b>
<b>10-11</b>	<b>Cobblestone Face</b>
<b>12-13</b>	<b>Ledgestone Face</b>
<b>14-15</b>	<b>Limestone Face</b>
<b>16-17</b>	<b>Gravity Retaining Walls</b>
<b>18-19</b>	<b>Flood Protection</b>
<b>20-21</b>	<b>Freestanding Walls</b>
<b>22-23</b>	<b>Flood Walls</b>
<b>24-25</b>	<b>Reinforced Walls</b>
<b>26-27</b>	<b>Vehicle Security Barriers (VSB)</b>
<b>28-29</b>	<b>Commercial Applications</b>
<b>30-31</b>	<b>Housing Applications</b>
<b>32-33</b>	<b>Landscaping Applications</b>
<b>34-35</b>	<b>Highways Applications</b>
<b>36-37</b>	<b>Rail Applications</b>
<b>38-39</b>	<b>Water Applications</b>
<b>40-41</b>	<b>Special Features / Installation</b>
<b>42-45</b>	<b>710 / 1040 / 1520 Series Blocks Drawings / Weights</b>
<b>46-47</b>	<b>Freestanding Corner Blocks 3 Sided / Coping Stones / Capping Blocks</b>
<b>48-61</b>	<b>Case Studies / Smart Motorways / Holiday Homes</b>
<b>62-63</b>	<b>CPD Style Presentations</b>

# What is Redi-Rock™

Redi-Rock™ modular walling precast products are made from durable, wet-cast concrete. Often referred to as one-tonne Lego® blocks, Redi-Rock™ blocks are big enough that they can be simply stacked on top of each other to construct a gravity wall.

For even taller and/or more heavily loaded retaining walls, the Redi-Rock™ Positive Connection (PC) system can be used to construct a mechanically stabilised earth (MSE) wall.

However, Redi-Rock™ is much more than simply large retaining wall blocks. Redi-Rock™ freestanding blocks have the same great look as the retaining blocks, with texture on two or more sides. These freestanding blocks are perfect for perimeter walls, entrance monuments, or parapet walls.

Redi-Rock™ accessory products include column blocks, steps, benches and capping blocks/coping stones. These accessories are perfect for completing your project

## Example / Cobblestone

Top Block



Middle Block



Bottom Block



# Freedom of choice

Redi-Rock™, offers you freedom of choice, available in three different finishes (Cobblestone, Ledgestone and Limestone) that can be coloured to suit your surroundings.

All product is supplied without colour unless specifically ordered. Colours may vary and exact colour match cannot be guaranteed and shading may vary.

Redi-Rock™ is a complete retaining wall solution that looks great. Engineers love it because it combines solid engineering and aesthetics, which can be a hard combination to find.

Example	Cobblestone	Limestone	Ledgestone
<b>1. Top Block</b> Grooved underside, dished top to accept surfacing			
<b>2. Middle Block</b> Grooved underside, domed top to accept next course			
<b>3. Bottom Block</b> Flat underside, domed top to accept next course			



## Cobblestone

The Cobblestone Redi-Rock™ block offers you a chiselled cobblestone texture that has the appearance of six small blocks and gives the wall a more natural uniformed look.



## Limestone

The Limestone Redi-Rock™ block has a quarried face that looks great on large scale projects. The one-tonne textured blocks offers walls an impressive finished appearance.



## Ledgestone

The Ledgestone Redi-Rock™ block offers you a deep, random textured wall, which blends in beautifully with natural stone. The individual blocks are nearly indistinguishable and therefore gives the impression of a natural, random stone wall.

**Your Complete Walling Solution**

# Key Benefits / We tick all the boxes



## **Build Faster**

Large interlocking blocks that are dry laid and can be built in any weather resulting in very fast construction. Full turnkey service available including design and installation.

## **Build Leaner**

Standard blocks are delivered ready to use, resulting in little or no waste.

## **Build Greener**

Over 25% of the block material content is recycled. Walls can be dismantled and relocated – The ultimate sustainable solution with minimal maintenance required.

## **Build Quality**

Factory produced quality product available in three natural looking, aesthetically pleasing finishes with built in engineered strength.

## **Build Smarter**

Varied designs are achieved using standard blocks resulting in space saving fast building solutions complimented with full design/engineering and installation support.

## **Build to Last**

Durability of wet cast concrete with a 100 year design life.

### Summary Specifications (1040 Series)

Block Face:	1170mm x 460mm
Block Depth and Mass:	Available in depths of 1520mm / 1040mm / 710mm
Concrete:	40N/mm <sup>2</sup> at 28 days
Lifting Device:	Lifting Insert Loop / Standard
Turning Radius:	Minimum 4.5m (varies by wall height)

Retaining wall batter of 5.0 degrees is automatically built into the wall via the design of the dome and groove locking mechanism

# Engineering / Design

---

We can work with you to provide a fully designed and engineered solution to any project requirement from planning to installation or have free software available for you to design your own wall at: [www.finesoftware.eu/geotechnical/redi-rock-wall/](http://www.finesoftware.eu/geotechnical/redi-rock-wall/)

## Full Engineering support including:

- ✓ Preliminary designs
- ✓ Calculations
- ✓ AutoCAD drawings
- ✓ Construction drawings
- ✓ Installation manual
- ✓ Full design submissions for customer approval
- ✓ Building Information Modelling (BIM)

## Structural Design:

- ✓ Bespoke software developed by FINE Civil Engineering Software
- ✓ Available as freeware for customer own designs
- ✓ Programmes for both Gravity and Reinforced Earth walls
- ✓ Designs to EN 1997-1:2004 and UK National Annex

# Professional Services

---

Marshalls CPM manufacture a wide range of precast concrete products which are required by the customer to be of consistent high quality, designed and manufactured to British/ European Standards and / or other customer requirements, and independently certified or Kite marked where applicable. Our objectives are not only to continue to meet these requirements, but also to provide a high standard of service in a professional manner, to supply products that are competitively priced, to work with customers, suppliers and designers on developing our product range, to develop user loyalty and so in doing so achieve strong business performance. We pride ourselves on our level of professional services.

To meet our objectives, the company applies a quality management system which has been developed in accordance with the requirements of ISO 9001 certification. The Company is committed to complying with these requirements in the future and also to regularly review the system for continuing suitability.

All employees, irrespective of their position and responsibilities, have an important role to play in ensuring our products and customer service is of a consistently high and acceptable standard.

Conformance with the requirements of the quality manual is mandatory for all staff.



**bimstore**

Download BIM and free Redi-Rock™ design software at [www.cpm-group.com](http://www.cpm-group.com)

# Accreditation / Approvals

Marshalls CPM is the only manufacturer of Redi-Rock™ modular walling in the United Kingdom mainland as licensed by Redi-Rock International. The modular walling solution has BBA approval, CE Marking, approval from the Highway Authorities Product Approval Scheme (HAPAS) and is British Kitemarked by PAS 68 certification

For further information please visit <http://www.cpm-group.com/about/accreditations/>

**Marshalls CPM**



**BRITISH  
PRECAST**

**Marshalls CPM**



**Marshalls CPM**



**Marshalls CPM**



**Marshalls CPM**



**Marshalls CPM**



**Your Complete Walling Solution**

# Cobblestone

By choosing Redi-Rock™ Cobblestone texture, you'll get the best of both worlds - the structural capabilities of a large block retaining wall with a smaller-scale look.

Each Cobblestone texture block has the appearance of six smaller blocks on each face, and individual blocks are nearly indistinguishable in a finished wall. Each block is cast-in a mould taken from real stone using wet-cast concrete, which gives walls a more natural finish while providing durability and strength.

Cobblestone blocks have the same massive dimensions, high quality, and ease of installation you expect from Redi-Rock™.



## Sample Block / Colour



### Cobblestone

The Cobblestone block offers you a chiselled cobblestone texture that has the appearance of six small blocks and gives the wall a more natural uniformed look.





**REDI-ROCK**  
MODULAR WALL SYSTEM

*Marshalls CPM Redi-Rock™ Cobblestone*



**Your Complete Walling Solution**

# Ledgestone

When you need a structural retaining wall, that will blend into the natural stone in your area, Ledgestone is the right choice.

The Ledgestone face creates deep texture and gives walls a random, natural look. The texture on each block makes individual blocks nearly indistinguishable in a wall, giving the impression of a natural, random stone wall.

Redi-Rock™ Ledgestone is the perfect solution for projects that require both superior aesthetics and superior strength.



## Sample Block / Colour



### Ledgestone

The Ledgestone Redi-Rock™ block offers you a deep, random textured wall, which blends in beautifully with natural stone. The individual blocks are nearly indistinguishable that gives the impression of a natural, random stone wall.





**REDI ROCK**  
MODULAR WALL SYSTEM

*Marshalls CPM Redi-Rock™ LedgeStone*



**Your Complete Walling Solution**

# Limestone

Redi-Rock™ Limestone texture creates a quarried face that offer an ideal look for projects that require a structural retaining wall that will look good too.

The massive, one-tonne (1040 series) Limestone textured blocks offers walls an impressive finished appearance. Redi-Rock™ Limestone face has been a mainstay in the large block retaining wall industry since it was introduced. The texture on each block gives walls a natural look and is consistently chosen for projects where aesthetics are important.



## Sample Block / Colour



### Limestone

The Limestone Redi-Rock™ block has a quarried face that looks great in large scale projects..





*Marshalls CPM Redi-Rock™ Limestone*



**Your Complete Walling Solution**

# Gravity Retaining Walls

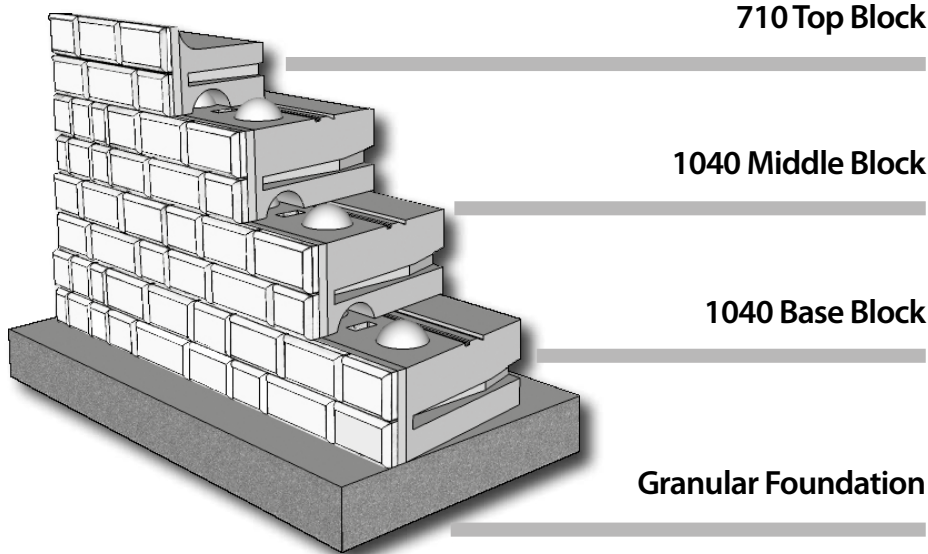

Marshalls CPM's Redi-Rock™ modular gravity retaining wall is large precast concrete blocks with a dome and channel joint which is available in three different finishes (Cobblestone, Ledgestone and Limestone) and relies on its own weight to retain the soil behind it.

The interlocking blocks are moulded from solid concrete, delivered ready to build as they are dry laid. They are fast to install and can improve the overall aesthetic look of your project and delivers an attractive, cost effective, high performance gravity wall structure.

## Redi-Rock v Competition

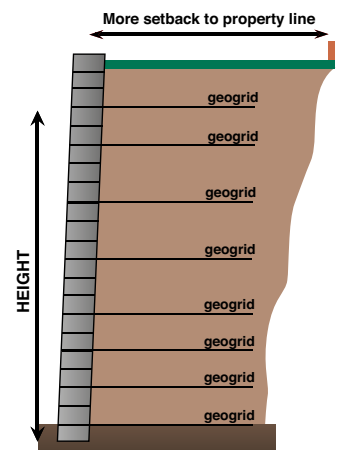
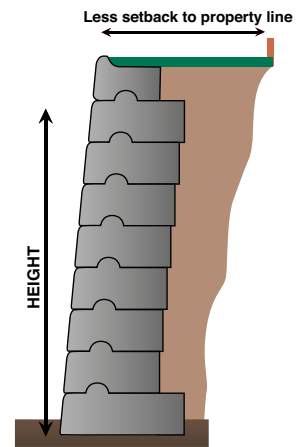

**REDI-ROCK**  
MODULAR WALL SYSTEM



*How high can you go?*



**Your Complete Walling Solution**

# Flood Protection

---

- **Critical Installations**
- **Erosion Control**
- **Pond Bunds**
- **River Containment**
- **Waterway Infrastructure**

---

To answer the national challenge of rising water levels, Marshalls CPM offers a range of flexible low cost, high quality solutions based on their innovative Redi-Rock™ interlocking modular wall system.

Whether looking to heighten river banks, build new sea walls or construct flood plain defences, Redi-Rock™ offers considerable benefits over alternative solutions, not least the aesthetically pleasing finish that Redi-Rock™ offers enabling it to blend perfectly into the local environment.





*River Teifi, Tregarron*



**Your Complete Walling Solution**

# Freestanding Walls

- **Barrier Walls**
- **Landscaping**
- **Perimeter Walls**
- **Modular Walls**
- **Privacy Walls**
- **Security Walls**

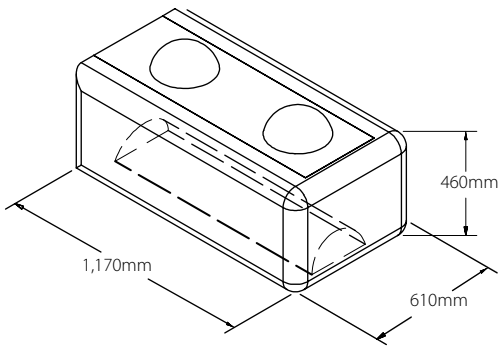

The massive Redi-Rock™ freestanding concrete blocks have textured faces on both sides of the block and are dry-laid and interlock like giant Lego® blocks. Quicker to install than conventional systems, they can also be coloured to match the local environment.

Redi-Rock™ freestanding walls are ideal to stand alone or integrate with a Redi-Rock™ retaining wall as they are fast and easy to install with minimal maintenance required.

Besides looking great, these freestanding walls serve as guardrails or barrier walls to protect areas from errant traffic or other threats and can be modified with cables or rods for additional force protection, as well as with a waterproof membrane for emergency or long term flood protection.

Marshalls CPM has the resources to make designing your freestanding wall easy and offers a full design service and installation, or we can supervise/advise when you need us to answer questions on your project.





*"Aesthetically pleasing, with the look of natural stone. Available in three finishes"*

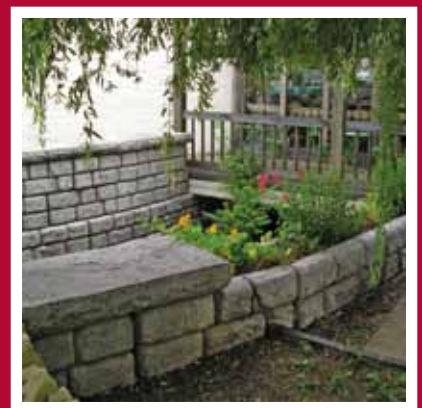

**Your Complete Walling Solution**

# Flood Walls

- River Bank Walls
- Flood Plains
- Waterways
- Reservoirs
- Inland Floodplain Defences

**bimstore**

Download BIM and free Redi-Rock™ design software at [www.cpm-group.com](http://www.cpm-group.com)

Marshalls CPM's Redi-Rock™ Flood Walls are ideal where space is scarce or areas where water may rise to unusual levels during seasonal or extreme weather conditions and are manufactured from precast concrete which has a proven track record of performance in water applications.

The Redi-Rock™ Flood Walls are double sided so look great whichever side of the wall you are on and are watertight. They are laid on a reinforced concrete strip foundation with starter bars into the hollow core. Wall reinforcement is then fixed as the blocks are laid. Once the blocks have been laid, the core is filled with concrete to form the watertight barrier, protecting surrounding areas from flood water.

As customer requirements are individual, so are the Flood Walls. They are designed to suit project specific size requirements by the Marshalls CPM Design team and are versatile enough to achieve height without compromising strength.



The flood blocks reinforced concrete strip foundation with starter bars into the hollow core.

Wall reinforcement is then fixed as the blocks are laid.

Once the wall has been completed the core is filled with concrete to form the watertight barrier, protecting surrounding areas from flood water.

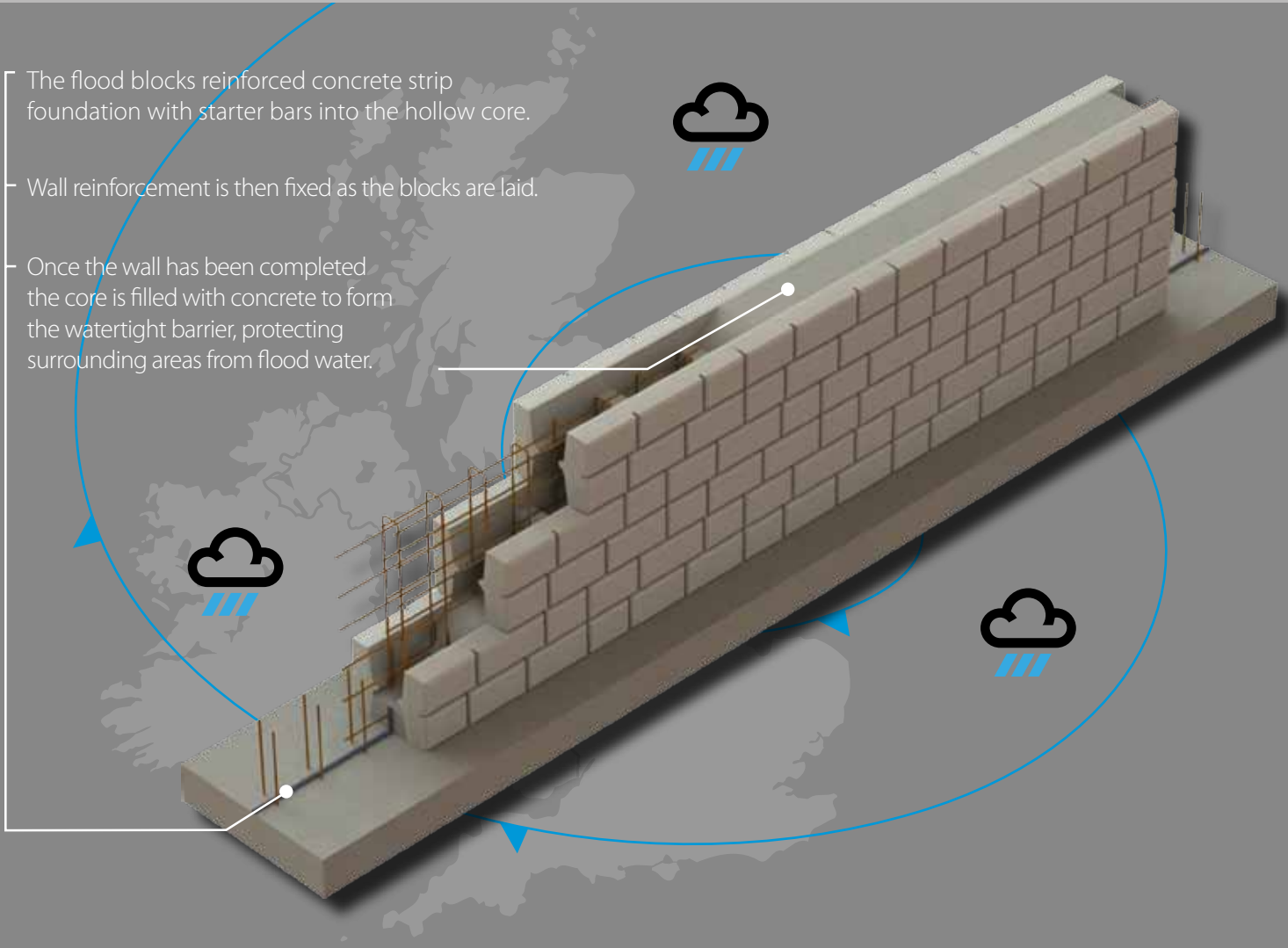

*"Redi-Rock is an ideal solution particularly the speed of which flood walls can be constructed" Tim Hopkins, Project Manager, Environment Agency*



**Your Complete Walling Solution**

# Reinforced Walls

## Positive Connection (PC) System

- Highways
- Harbours
- Bridge Abutments
- Commercial Projects
- Embankments

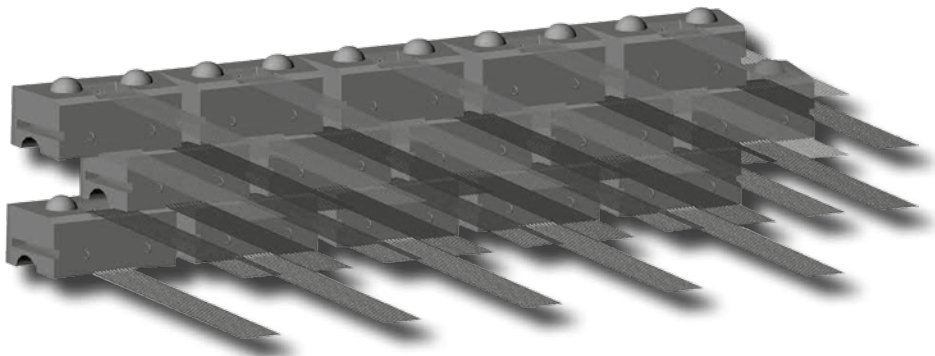

Marshalls CPM's Redi-Rock™ reinforced walling or positive connection system (PC) is used in conjunction with a geogrid has been rigorously tested and is used when either an increased load or height is required. Due to the massive size of each block, using the system can reduce time and money spent on installation.

This Redi-Rock™ system combines stability with the natural appearance of stone with the established performance of geogrid reinforcement through a simple and highly efficient positive connection with the Redi-Rock™ reinforced block. The Redi-Rock™ product is simple but massively effective.



300mm wide strip of geogrid wrap through the blocks extending full length back in to reinforced fill zone



**REDI-ROCK**  
MODULAR WALL SYSTEM



*Dawnus Construction, Foryd Harbour, Wales*



**Your Complete Walling Solution**

# Vehicle Security Barriers (VSB)

- **Utility and Critical Infrastructure**
- **Buildings of High Importance**
- **Military Facilities**
- **Crowded Places**
- **Civil/Nuclear Installations**
- **Transport Hubs**
- **Tourist Areas**

**Fast to install Lego® like system security blocks**  
**Removable / Relocatable**  
**No ground anchor - uses its own weight.**  
**Integral cable dissipates kinetic energy**  
**Proven to stop a 7.5 Tonne truck at 48 km/h (30mph)**  
**Aesthetically pleasing, with the look of natural stone**  
**Can be coloured to blend with local environment**

All block styles are available with 75mm Horizontal Tube (for post tension cable) and/or 150mm Vertical Tubes (for mechanical tie-down bolts) to allow the blocks to be used in a Force Protection application.

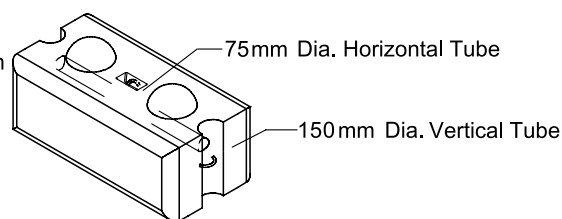

(Straight full bottom block shown)

Redi-Rock™ hostile vehicle mitigation walling (Vehicle Security Barriers – VSB) is an effective, re-usable solution to perimeter hostile vehicle attack. Ideal for utility and critical infrastructure, buildings of high importance, military facilities, crowded places, civil/nuclear installations and transport hubs.

The Redi-Rock™ Force Protection system has been successfully tested by the Transport Research Laboratory (TRL) using the BSI specification PAS 68:2007, and achieved a classification of V/7500[N2]/48/90:1.6/0.0. To achieve this the freestanding concrete blocks systems interconnected with steel cable successfully arrested a 7.5 tonne lorry at impact speed of 48 kmph (30mph) with only 1.6m penetration of the load carrying space.





*"The vehicle security barrier system that protects from vehicle impact."*



**Your Complete Walling Solution**

# Commercial Applications

---

- **Retail Parks**
- **Car Parks**
- **Educational Buildings**
- **Office Buildings**
- **Warehouses**
- **Golf Clubs**

---

Marshalls CPM's Redi-Rock™ offers an alternative retaining wall solution for commercial developments such as retail parks and office building as it minimises land take that can often mean more car parking spaces and greater protection against both landslips or vandals

The modular walling system has been used on golf clubs to protect areas whilst offering a landscaping finish as well as educational buildings to safeguard children from unwanted visitors.

Marshalls CPM can work with you to provide a fully designed and engineered solution.





*Seymour Regeneration, Markham Vale, Mansfield*



**Your Complete Walling Solution**

# Housing Applications

---

- Private Housing
- Social Housing
- New Build
- Self Build
- Housing Estates
- Country Estates

---

Marshalls CPM's Redi-Rock™ natural stone looking retaining wall is versatile enough to achieve height without compromising on strength, with fully engineered plans pre-drawn for different heights and ground conditions.

Marshalls CPM can work with you to provide a fully designed and engineered solution to any project requirement, from planning to installation.

Marshalls CPM's Redi-Rock™ retaining wall series offers low project costs and a high quality solution that saves money and releases more land, whilst the blocks provide an attractive finish.





*David Wilson Homes, Holmfirth, Yorkshire*

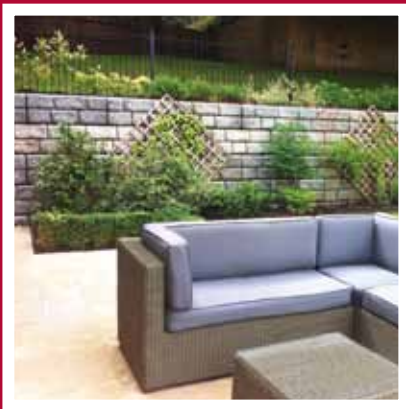

**Your Complete Walling Solution**

# Landscaping Applications

---

- Private Houses
- Housing Developments
- Parks and Gardens
- Industrial Developments
- River Embankments
- Retail Parks
- Country Estates

---

Marshalls CPM's Redi-Rock™ landscaping collection features the timeless look of natural stone and is a great addition to Redi-Rock™ retaining and freestanding walls as they coordinate beautifully.

Redi-Rock™ planters and sophisticated curves make Redi-Rock™ one of the most attractive retaining wall systems available. As well as being easy to install it is offered in three different faces: Cobblestone, Limestone and Ledgestone, which can be coloured to match your location.

An easy to install design, Redi-Rock™ walling has been used on a large collection of landscaping projects, including commercial and private estates, providing a natural stone 'look' wall with a low maintenance option that compliments the natural environment.





*Friel Homes, Tutbury, Gloucestershire*



**Your Complete Walling Solution**

# Roads / Highways

- Motorways
- Roads
- Embankments
- Cuttings
- Bridge Abutments
- Wing Walls



The modular walling solution has BBA approval, CE Marking, approval from the Highway Authorities Product Approval Scheme (HAPAS) and is British Kitemarked by PAS 68 Certification. The walls are versatile enough to achieve height without compromising on strength. With fully engineered plans pre-drawn for different heights and ground conditions, we will work with you to provide a fully designed solution.

Large cost savings over traditional applications are possible as Redi-Rock™ can be installed in any weather conditions offering fast installation and less land take.

Special "Smooth Limestone" finish for Highway projects with a tighter radius edge is available upon request.





*A24 Broadbridge Heath, Horsham*



**Your Complete Walling Solution**

# Rail Applications

- **Trackside**
- **Embankment**
- **Cuttings**
- **Light Rail Transit Lines**
- **Metro Links**

Marshalls CPM's Redi-Rock™ modular concrete walling is ideal for protecting the railway lines against erosion, landslips and rock falls, as the big block solution is both quick and easy to install when you have limited 'track time' available or night-time possessions.

With less disruption to services through quick and economical installation in any weather, the Redi-Rock™ blocks have the look of natural stone and are available in three different faces (Cobblestone, Ledgestone and Limestone), so blend in with the natural environment and are versatile enough to achieve height without compromising strength. Another major advantage is that they require less space than traditional methods of construction.

Each modular block weighs approximately one tonne, (1040 series) can be dry laid in any weather, so walls can be built in a fraction of the time and at reduced costs compared to other methods, a real benefit when closing the rail network for trackside maintenance and improvements.

With its strength and earth retaining capabilities Redi-Rock™ modular walling keeps both the train and track safe whilst offering a pleasant viewing and safe experience for rail passengers, making it an obvious choice for the rail industry.

Each modular block weighs approximately one tonne (1040 series) can be dry





*Carillion / Buckingham JV, Bicester to Oxford Route*



**Your Complete Walling Solution**

# Water Applications

---

- **River Bank Walls**
- **Flood Plains**
- **Harbour Walls**
- **Reservoirs**
- **Shoreline Protection**
- **Waterways**

---

The Marshalls CPM Redi-Rock™ retaining wall system is ideal for use where there is water, such as lakes, streams, rivers and harbours.

Ideal for directing water from a property, heightening river banks, building new sea walls or constructing flood plain defences, the walls are created by engineers for engineers and are well known to perform against freeze thaw cycles, marine environments and record-setting storms.





*Rhyl Harbour Quay Wall, North Wales*

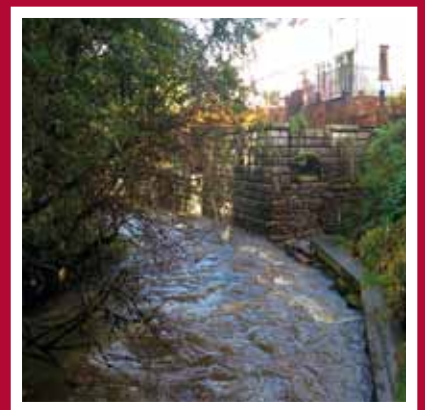

**Your Complete Walling Solution**

## Special Features

Marshalls CPM can offer special features in Redi-Rock™ such as benches, curves and corners to co-ordinate with your retaining wall. From flower beds to columns, Marshalls CPM's Redi-Rock™ is easy to install and can be coloured to suit your surroundings.



# Redi-Rock™ Installation

## Example / Cobblestone

### Top Block



### Middle Block



### Bottom Block



Redi-Rock™ modular walling installs like one tonne Lego™ and who doesn't love playing with Lego™? Each massive one tonne block has a dome and groove design that makes retaining walls fast and easy to install. All that's required is a small excavator and a 1-2 person crew. With over 0.5m<sup>2</sup> of face per block, walls go up fast and the design of the modular blocks allows for curved walls, 90 degrees corners and much more to make a custom wall simple to install.

With fork slots for easy loading and unloading during retaining wall construction, you'll be glad you chose Redi-Rock™ for your project!

For more information, an installation guide or to see Redi-Rock™ being installed please visit [www.cpm-group.com](http://www.cpm-group.com) or contact the team on 01179 814500 or email [redirock@marshalls.co.uk](mailto:redirock@marshalls.co.uk)



Corners are achieved using a combination of retaining and freestanding series blocks.

**Your Complete Walling Solution**

# Dimensions / Weights / 710 Series Blocks

## Top

Full Block (71T)  
Mass = 555 kg

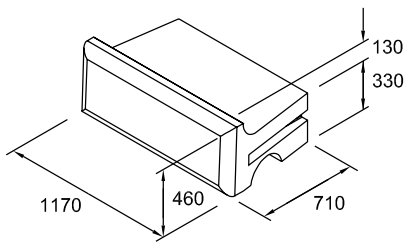

## Half Top

Half Block (71HT)  
Mass = 268 kg

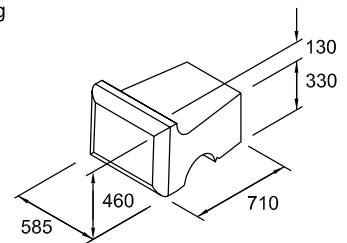

## Middle

Full Block (71M)  
Mass = 739 kg

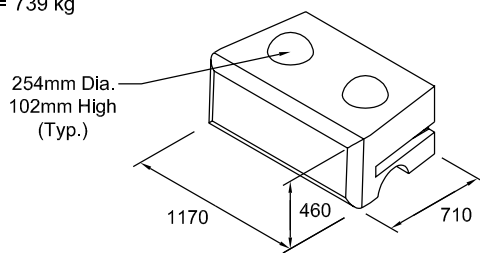

## Half Middle

Half Block (71HM)  
Mass = 347 kg

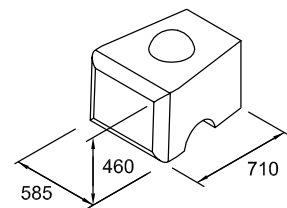

## Bottom

Full Block (71B)  
Mass = 802 kg

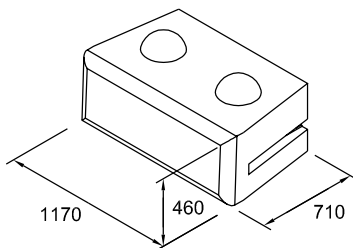

## Half Bottom

Half Block (71HB)  
Mass = 375 kg

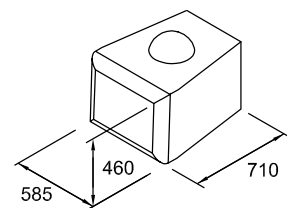

Actual weights may vary, dimensions are based on a Cobblestone finish

# Dimensions / Weights / 1040 Series Blocks

## Middle

Full Block (104M)  
Mass = 1066 kg

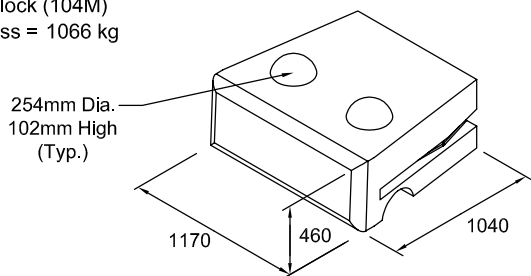

## Bottom

Full Block (104B)  
Mass = 1126 kg

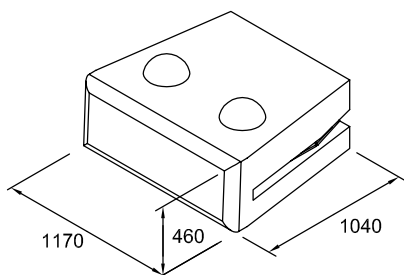

## Planter - 422 mm Offset

Full Block (104P)  
Mass = 916 kg

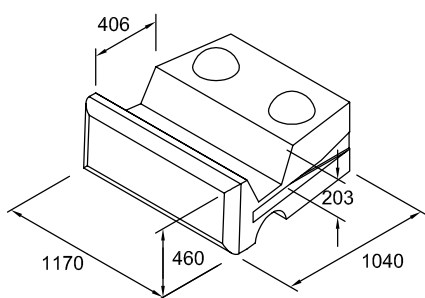

## Half Middle

Half Block (104HM)  
Mass = 472 kg

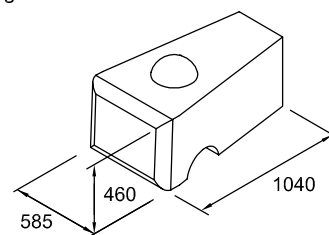

## Half Bottom

Half Block (104HB)  
Mass = 501 kg

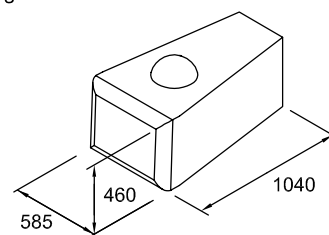

## Half Planter - 422 mm Offset

Half Block (104HP)  
Mass = 404 kg

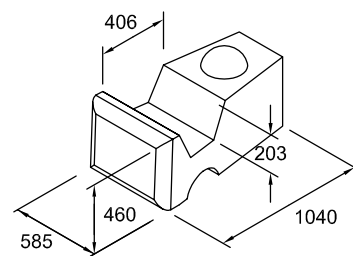

Actual weights may vary, dimensions are based on a Cobblestone finish

Your Complete Walling Solution

# Dimensions / Weights / 1520 Series Blocks

## Middle

Full Block (150M)  
Mass = 1492 kg

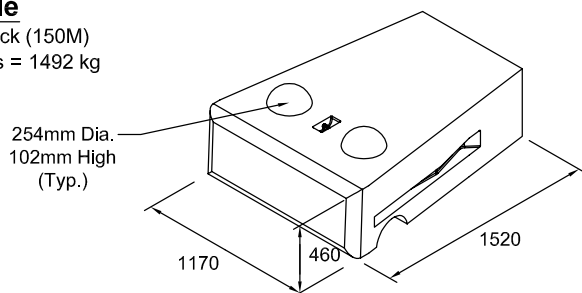

## Half Middle

Half Block (150HM)  
Mass = 604 kg

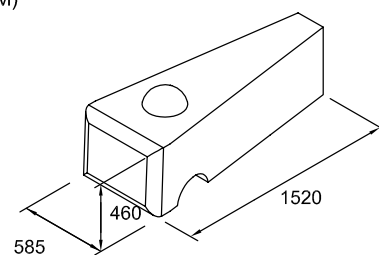

## Bottom

Full Block (150B)  
Mass = 1551 kg

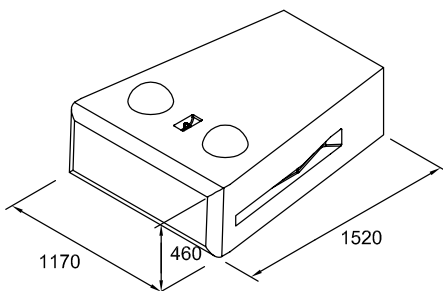

## Half Bottom

Half Block (150HB)  
Mass = 632 kg

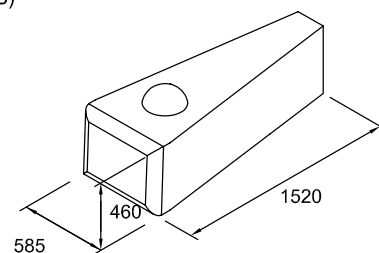

## Planter - 422 mm Offset

Full Block (150P)  
Mass = 1342 kg

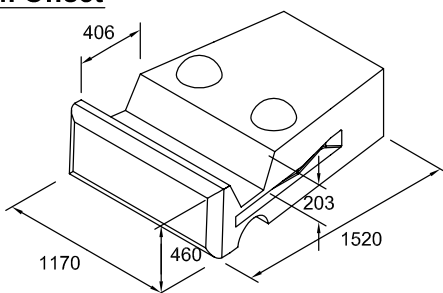

## Half Planter - 422 mm Offset

Half Block (150HP)  
Mass = 536 kg

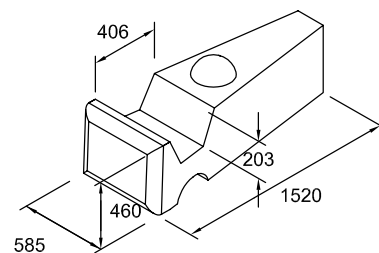

Actual weights may vary, dimensions are based on a Cobblestone finish

# Freestanding Blocks / 2 Sided

## Straight Top

Full Block (ST)

Mass = 679 kg

Half Block (HST)

Mass = 339 kg

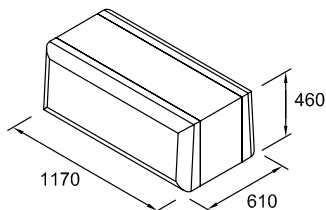

## Curved Top

Full Block (CT)

Mass = 651 kg

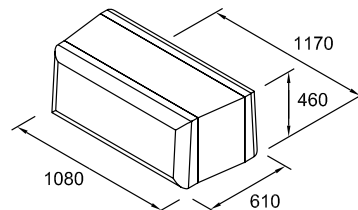

## Straight Garden

Full Block (SG)

Mass = 518 kg

Half Block (HSG)

Mass = 257 kg

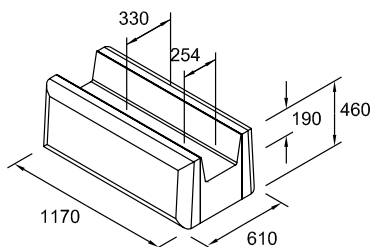

## Curved Garden

Full Block (CG)

Mass = 496 kg

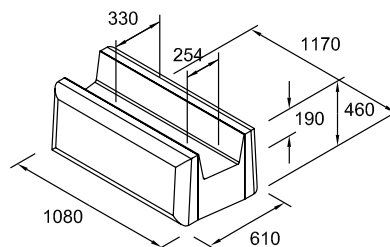

## Straight Middle

Full Block (SM)

Mass = 693 kg

Half Block (HM)

Mass = 346 kg

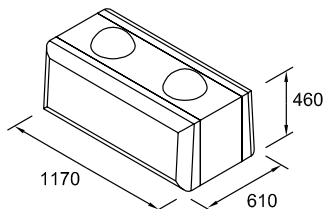

## Curved Middle

Full Block (CM)

Mass = 665 kg

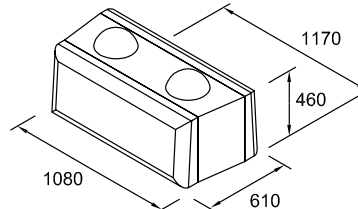

## Straight Bottom

Full Block (SB)

Mass = 748 kg

Half Block (HSB)

Mass = 372 kg

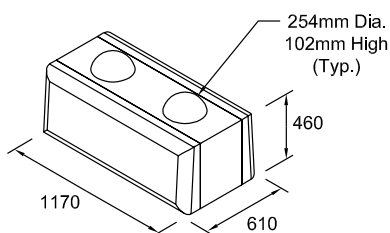

## Curved Bottom

Full Block (CB)

Mass = 720 kg

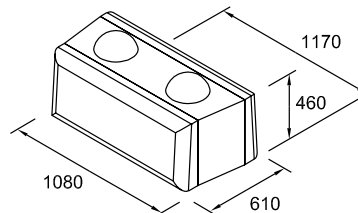

## Force Protection

Straight blocks can be manufactured with a 75 mm horizontal tube for post-tensioned cable installation.

Straight and curved blocks can be manufactured with 150 mm vertical tubes for mechanical tie-down bolt installation.

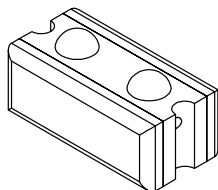

(Straight Bottom Shown)

## Variable Radius Walls

Straight block styles can be manufactured with the end block insert to allow the blocks to be cut and used in a variable radius wall.

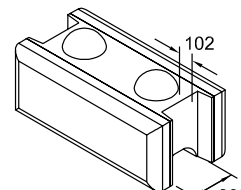

(Straight Middle Shown)

# Freestanding Corner Blocks 3 sided

## Top Corner

Full Block (TC)

Mass = 677 kg

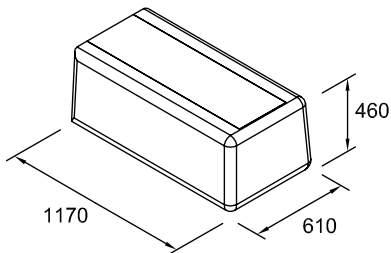

## Half Top Corner

Half Block (HTC)

Mass = 336 kg

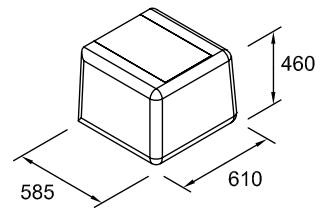

## Garden Corner

Full Block (GC)

Mass = 536 kg

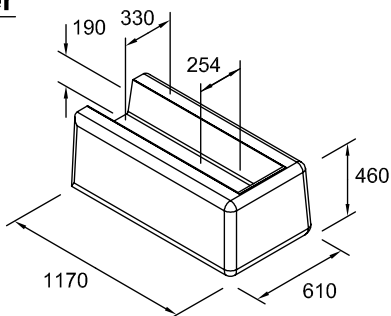

## Half Garden Corner

Half Block (HGC)

Mass = 275 kg

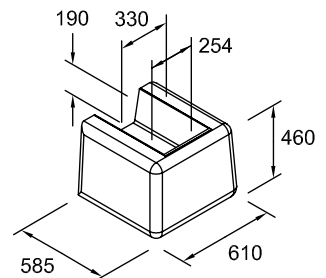

## Middle Corner

Full Block (MC)

Mass = 696 kg

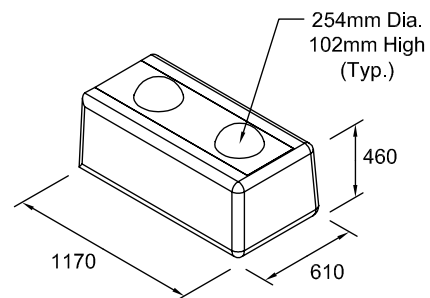

## Half Middle Corner

Half Block (HMC)

Mass = 343 kg

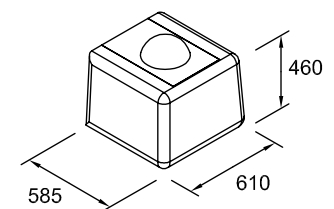

Actual weights may vary, dimensions are based on a Cobblestone finish

# Capping Blocks / Coping Stones

## Two-Sided Cap

Weight = 292 kg ±

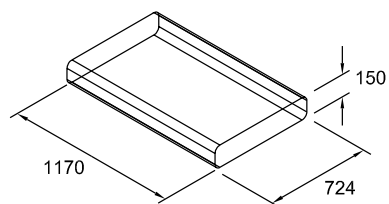

## Two-Sided Curve Cap

Weight = 281 kg ±

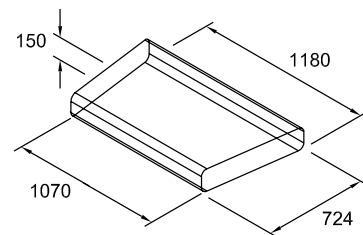

## Three-Sided Cap

Weight = 303 kg ±

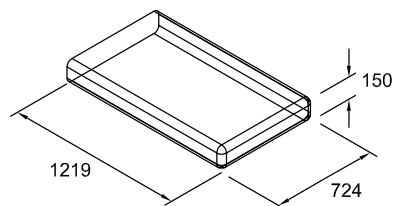

## Four-Sided Cap

Weight = 312 kg ±

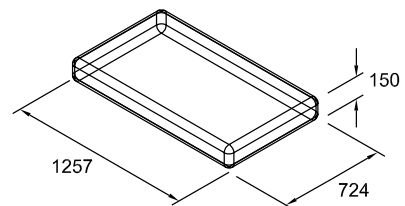

## Two-Sided Half

Weight = 146 kg ±

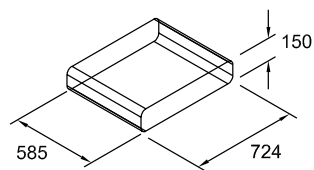

## Three-Sided Half

Weight = 157 kg ±

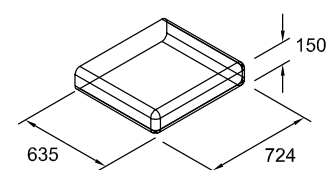

Actual weights may vary, dimensions are based on a Cobblestone finish

Your Complete Walling Solution

# Case Studies / Coastal

<b>Project</b>	<b>Rhyl Harbour Development</b>
<b>Location</b>	<b>North Wales</b>
<b>Contractor</b>	<b>Dawnus Construction</b>
<b>Architect</b>	<b>Pell Frischmann</b>
<b>Consultant</b>	<b>GroundSolve Geotechnical Consultants</b>
<b>Client</b>	<b>Denbighshire County Council</b>

## Project Brief

In the Spring of 2012, a massive construction project to transform Rhyl broke ground with the goal of increasing tourism and boosting the local economy; Another key goal of the project was to provide a safer, more scenic route for pedestrians and cyclists as part of the Wales Coast Path which follow the entire coastline of Wales. The third phase of the scheme began in 2012 and included the construction of a 188m extended quay wall, a new public square and deepened harbour channel to improve navigation.

## Marshalls CPM Solution

After exploring various walling materials that would match the visual scale and structural requirements needed, it was decided that Marshalls CPM's Redi-Rock™ walling would be used because of resulting visual impact it has and the cost incentives that the Redi-Rock™ positive connection walling offers. The wall elevations were designed based on the 100 year extreme water level from the Environment Agency.

Marshalls CPM in conjunction with Groundsolve Ltd Geotechnical Consultants designed the reinforced earth walls and whilst this system had been used on a number of occasions in America, it is the first time it had been used in the UK.

The use of Redi-Rock™ walling allowed the contractor to install approximately 50 number blocks over a tidal cycle, with the whole construction of the 188m long, up to 7.5m high quay wall being undertaken in just 30 weeks.

## Client Comments

"The Redi-Rock™ product is very simple but massively effective. It is easy to install and the end product looks fantastic, I would definitely use this product again. The service we received from Marshalls CPM was second to none. They always made a conscious effort to put our needs first."

Jamie Turner – Site Agent, Dawnus Construction





**REDI-ROCK**  
MODULAR WALL SYSTEM

*"Redi-Rock quay wall is 188m long, by 7.5m high constructed in just 30 weeks"*



**Your Complete Walling Solution**

# Case Studies / Flood Protection

**Project** Defensive Flood Wall,  
**Location** Cockermouth, Cumbria  
**Contractor** Ian Cannon Civil Engineering

## Project Brief

Cockermouth may have been badly hit by the flooding from Storm Desmond but one local resident was glad he chose Marshalls CPM's Redi-Rock™ modular walling to protect his property from the Tom Rudd Beck.

## Marshalls CPM Solution

Mike Wallis of Meadow Bank Close had the Redi-Rock™ flood protection walling installed by Ian Cannon Civil Engineering during 2014 due to the threat of flooding. He was relieved to see it had done its job as this is the second time Cockermouth has been under water in recent years as it was badly affected by the 2009 floods.

## Client Comments

John O'Gara, Marshalls CPM's Specification Sales Manager said, "Redi-Rock™ walling is ideal for locations such as Cockermouth, where you want flood defenses to blend into the natural surroundings during the rest of the year but then to protect your property when flooding occurs and Redi-Rock does exactly that. It can be installed in any weather, into water courses and requires no maintenance afterward. The cost savings are typically more than 30% better compared to other flood systems. I cannot believe I was paddling about in that water as we started on site and now its rushing passed the houses at quite a pace"

Mr Wallis commented "We were out when we heard about the flooding and just hoped that the wall held the water back and it has done just that, it's taken a weight off our minds when we look around the neighbouring towns and villages and see what damage its done to their property. I would definitely recommend Marshalls CPM walling"

*Before.. Redi*



*Redi-Rock™ Flood Wall*



*After.. Redi-Rock™ Flood Wall*



*Redi-Rock defensive flood wall in action, Cockermouth, Cumbria*



**Your Complete Walling Solution**

# Case Studies / Housing

**Project** The Glass Works

**Location** Burton on Trent

**Contractor** Friel Homes

## Project Brief

The site was a former glass works factory dating back to the 1500's in the centre of the historic town of Tutbury, near Burton on Trent, making this a very strategic site for planning and a focus for the existing villagers. Its topography was considerably challenging for design and already had significant retaining walls up to 7 meters tall. Therefore, the proposed design for the site had to take into account the restrictions placed upon it as well as offering an aesthetic outlook.

As Friel's were both the client and the contractor, the wall design had to include their construction issues of building within in a tight, sloped site with access restrictions whilst maintaining all the very necessary requirements of the Health and Safety guidelines.

## Marshalls CPM Solution

After investigating the possibilities of in-situ concrete walls, timber walls, precast panels and gabions the decision was made to specify the Redi-Rock™ system.

## Client Comments

"This was primarily due to the fact it fitted all our criteria bar one. The system gave us a quick easy build solution which looked good and reduced the Health and Safety issues, the missing criteria was the cost.

The initial payment for the materials was higher than our budget, but due to its exceptional speed of erecting our build program was reduced from a programmed 5 weeks to a staggering 8 days, which included training the operatives which would be reduced further on future walls, giving an overall saving on the budget.

The result was a 50m long 2.5m high wall in just over a week, with comments from both operatives and local residents which were all positive. We are now currently progressing our next site using this system."

Andrew Bache, Development Manager, Friel Homes





*"The Redi-Rock build programme was reduced from 5 weeks to 8 days"*



**Your Complete Walling Solution**

# Case Studies / Commercial

**Project** Fox Valley Retail Development, Phase 1

**Location** Sheffield

**Contractor** Henry Boot

**Architect** Pell Frischmann

## Project Brief

Following the demolition of Tata garages, Outokumpu offices, Tata warehouse and a year of remediation work, the new Fox Valley retail facility was ready to be built, which included retail outlet shops and parking for 600 vehicles.

The development is designed to be in keeping with the area's industrial heritage and fulfils the requirement for a new retail and commercial development in the area.

## Marshalls CPM Solution

To ensure that the maximum amount of space was optimised for car parking Marshalls CPM's Redi-Rock modular walling was installed which is versatile enough to achieve the required height without compromising on strength. Designed by Pell Frischmann, the natural stone looking retaining wall was quick to install and offered lower project costs.

## Client Comments

David Goddard, Senior Project Manager for Henry Boot said:

"This has been a complex project involving the remediation and complete redevelopment of a former steelworks. It was a major undertaking for our company and has successfully transformed the North Sheffield site into a vibrant shopping centre creating 900 jobs for the local community."

Since the official opening, Fox Valley has been used for the 2017 Tour de Yorkshire race, where the world's best cyclists used the event as a dress rehearsal for the 2019 UCI World Championships which are to be held in the UK.





*Redi-Rock wall designed with the local industrial heritage in mind*



**Your Complete Walling Solution**

# Case Studies / Rail

<b>Project</b>	<b>East-West Rail Phase 1, Wolvercote</b>
<b>Location</b>	<b>Carillion Buckingham Group Joint Venture</b>
<b>Client</b>	<b>Network Rail</b>
<b>Architect</b>	<b>Atkins</b>



## Project Brief

East West Rail Phase 1 is a £320M project to rehabilitate a 16km section of railway between Oxford and Bicester. The project involved stabilisation and widening of existing rail earthworks formed in the 1850s.

The project called for a modular concrete block wall at Wolvercote Tunnel, as gabion baskets had proven slow and difficult to build on another part of the project. The wall design included an asymmetric alignment to provide flexible positioning of future OLE and Box-out features for lineside equipment.

## Marshalls CPM Solution

Marshalls CPM designed a solution for the embankment wall in their Cobblestone block walling which was approved by leading consultants, Atkins and Network Rail. However project changes were made during construction, which were redesigned by Marshalls CPM using the Redi-Rock™ engineering analysis software and approved by Atkins. Due to the ease of which the walling solution can be installed, the delivery schedules were altered demonstrating the flexibility of the system.

## Client Comments

Barry Mullen, Project Manager - Carillion Buckingham JV "The assistance we have had from Marshalls CPM with the Redi-Rock™ walling, from the Sales team liaising with site schedules as well as the patience from the Design team have really been appreciated by us"

The use of the precast concrete modular gravity Redi-Rock™ wall provided a cost effective and aesthetic solution that was rapid to install on a congested site. The precast modular wall allowed for local remodeling around existing features such as bridge abutments.



*East-West Rail Phase 1, Wolvercote Cutting and Widening*



**Your Complete Walling Solution**

# Case Studies / Roads

<b>Project</b>	<b>A50 Westbound Blurton to Trentham Lakes</b>
<b>Location</b>	<b>Stoke on Trent</b>
<b>Contractor</b>	<b>Kier Construction</b>
<b>Sub Contractor</b>	<b>Carnell Group</b>
<b>Client</b>	<b>Highways England</b>



## Project Brief

A Highways England project to add an extra lane on the Westbound A50, which took place between 8.00pm and 6.00am to minimise carriageway closures. The project is designed to improve journeys for motorists and ease congestion and requires a 270m long 2.15m high retaining wall along the A50.

## Marshalls CPM Solution

Redi-Rock™ modular blocks with Ledgestone finish and a bespoke colour have been used, with the base row comprising mainly of the larger 150 series gravity wall blocks. Subsequent courses were the 104 and 71 series gravity blocks.

The majority of the wall was constructed during 5 hour night shifts to ensure less disruption to the roadway during the day. The entire 270m long bottom course was built in just 5 night shifts (25 hours). (The bottom course is the slowest part of the process).

The other courses were built during night shifts with 120 blocks being installed during each 5 hour shift (64m<sup>2</sup>).

## Client Comments

"These outputs couldn't have been bettered" Carnell Group

Following an early completion of the project Mark Winnington, Staffordshire County Council's Cabinet member for Economic Growth, said: "We scheduled the work to take place at night to minimise any inconvenience and I'm very pleased it's been completed so quickly, safely and efficiently."



*"These outputs couldn't have been better"*



**Your Complete Walling Solution**

# Smart Motorways



# Holiday Parks / Lodge Homes



**Your Complete Walling Solution**

# CPD Style Presentations

Marshalls CPM is able to offer CPD style presentations on our Retaining Walls, Perfect Manhole and Water Management precast concrete solutions. We are happy to come to your place of work for a lunch-time presentation or offer visits to our production facilities. A certificate is offered with every presentation.





Water Management | Precast | Retaining Walls

# Certificate of Achievement

Awarded to

.....

For the successful completion  
of a Redi-Rock™ course

Marshalls CPM



Date .....

## Complete UK Coverage

### ENGLAND / WALES SALES AND SOUTHERN WORKS

Marshalls CPM, Mells Road, Mells,  
Nr Frome, Somerset, BA11 3PD  
Tel: 01179 814500 Fax: 01179 814511

### NORTHERN WORKS

Marshalls CPM, Pollington, Goole,  
East Riding of Yorkshire, DN14 0DU  
Tel: 01405 860591 Fax: 01405 863606

### SCOTLAND SALES

Marshalls CPM, 101 Main Street, Newmains,  
Wishaw, Lanarkshire, ML2 9BG  
Tel: 01698 386922 Fax: 01698 387167

### PERFECT MANHOLE SALES

Marshalls CPM, 1st Floor Alexandra Mill,  
Queen Street, Leek,  
Staffordshire, ST13 6LP  
Tel: 01538 380500 Fax: 01538 380510

### TECHNICAL OFFICES

Marshalls CPM, CPM House,  
Heath Mill Road, Wombourne,  
Staffordshire, WV5 8AP  
Tel: 01902 356220 Fax: 01902 356221



[redi-rock@marshalls.co.uk](mailto:redi-rock@marshalls.co.uk)  
[www.cpm-group.com](http://www.cpm-group.com)

