

Product Guide

Programmable Extension Timer with 12 Hour extension

today, tomorrow and in the future

mselectronics.co.uk

Product Overview

The E315 is a single-shot extension timer designed to control plant equipment such as heating, lighting or air-conditioning systems outside of normal occupancy hours. A voltage-free changeover relay output capable of switching loads of up to 10A is switched on for a configurable number of hours.

The unit is an extremely user-friendly device with touch-sensitive pushbuttons, an LED display and a fully adjustable extension period (in half hourly stages), providing simple yet powerful control of plant equipment.

The E315 combines precise and accurate operation with fully configurable parameters to provide effective energy control. This efficient timer offers an adjustable “Extension” period from 1 to 12 hours in hourly intervals. The unit also provides the functionality to pre-set a maximum “Extension” period at hourly intervals to ensure that the end-user does not abuse the extension duration, so allowing the authorised user control over each and every extension period. When not in use, the E315 enters a power-saving standby mode in an effort to reduce its energy usage.

The E315 effectively reduces energy bills and benefits the time-management of personnel through the efficient control of plant equipment.

Product Wiring

1. **IMPORTANT:** ensure all electrical connections are isolated before commencing any work on the unit.
2. Power to the E315 extension timer is provided via the Live and Neutral input terminals labelled “L” and “N” on the circuit board. It is universally compatible with all worldwide mains power (85—265V AC, 50-60Hz).
3. A voltage-free changeover relay output capable of switching loads of up to 10A, 230V AC (resistive) is provided by the extension timer.
4. The Common “COM” terminal is connected to the Normally Open “N/O” terminal during the extension period, otherwise it is connected to the Normally Closed “N/C” terminal at all other times.

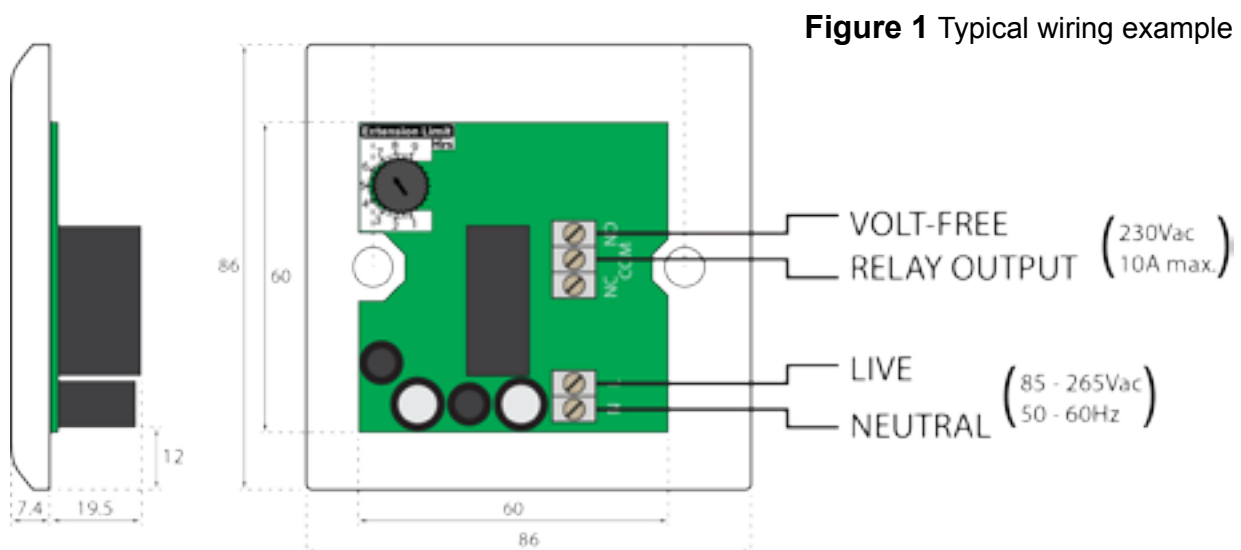

Installation

1. **IMPORTANT:** ensure all electrical connections are isolated before commencing any work on the unit.
2. The E315 is designed to be mounted in a 22mm (or deeper) single-gang UK pattress box.
3. Connect the wiring to the terminal blocks on the extension timer as shown in Figure 1 (or any suitably appropriate form). Make sure to choose the correct output terminals that are suitable to your application.
4. Adjust the “Extension Limit” dial to suit the operational requirement (see the “Operation” section).
5. Secure the E315 into the pattress box using the two supplied M3.5 screws.
6. Fit the supplied screw covers to complete the installation.
7. To remove the screw covers without damage, use sticky tape or blu-tack as an aid.

Operation

IMPORTANT: ensure all electrical connections are isolated before commencing any work on the unit.

During installation, adjust the “Extension Limit” dial to select the maximum number of hours the end user may select for the extension period (typical setting: up to 4 hours).

Operation Modes

The E315 has 3 operating modes:

- Standby: Power-saving mode where the dimmed LED displays show “0” on all digits.
- Setting Up: Bright LED displays with the currently selected digit blinking. If no extension is activated within 2 minutes in this mode the E315 will revert back to the Standby mode.
- Running: Bright LED displays with the “Running” LED blinking. The “On” LED illuminates to show the extension is active. Once the extension is complete the E315 will revert back to the Standby mode.

“Increase” Pushbutton

- Press: Increments the blinking digit by 1 unit (numbers will wrap-around to the minimum value when they reach the maximum value).
- Hold: Increments the blinking digit automatically while held down.

“Select/Start” Pushbutton

- Press: Selects the next digit to adjust (has no effect when in the “Running” mode).
- Hold: Starts or stops the extension.

Typical Example

Setting up a 11 hour extension period:

- a. From the Standby mode touch either pushbutton to select the first digit of “Extension” in the Setting Up mode.
- b. Hold or repeatedly press the “Increase” pushbutton until the digit shows “1”.
- c. Touch the “Select” pushbutton to select the second digit of “Extension”.
- d. Hold or repeatedly press the “Increase” pushbutton until the digit shows “1”.
- e. Hold “Start” to start the extension running (Running mode). The “Running” LED will begin to flash once every second while the extension is running.

The relay output will be activated for 11 hours (also shown by the “On” LED illuminating for those 11 hours).

Additional Operating Guidelines

- a. An active extension may be cancelled at any time by holding down the “Select/Start” button for 2 seconds.

Technical Specification	
Power supply:	85 - 265V AC, 50 - 60Hz (worldwide universal)
Output switch rating:	10A, 230V AC (resistive)
Output switch type:	Changeover relay (volt-free)
Operating temperature:	-10°C to +40°C
Suitable for:	22mm (or deeper) single-gang UK pattress box
Guarantee:	5 Years
Weight:	97g
Dimensions mm:	186mm x 86mm x 26.9mm

Technical Support

For further help or information on this and the other products in the ms electronics range visit www.mselectronics.co.uk or call 0333 666 1176.

Alternatively, email techsupport@mselectronics.co.uk
Additional copies of this product guide can be downloaded from our website.

Product Warranty

M.S. Electronics guarantees all their products against manufacturing defects for 5 years from the purchase date. If your product is found to be faulty, M.S. Electronics will, at their discretion, repair or replace the product free of charge.

Note

Any modification or damage to the outer casing of the thermostat, as well as any damage to the product due to abuse or incorrect wiring may invalidate the guarantee.



e: info@mselectronics.co.uk
t: 0333 666 1176 f: 0333 666 1436



mselectronics.co.uk

M.S. Electronics reserves the right to alter or change this specification without prior notice.