



Pirate Ship



Pirate Ship



MEMBER OF
THE ASSOCIATION
OF PLAY
INDUSTRIES

PO Box 707, Mold CH7 1FG

Tel: 01244 375627

Fax: 01244 374990

Email: sales@creativeplayuk.com

Website: www.creativeplayuk.com

creative
play

creative play

PLAYGROUNDS AND EQUIPMENT

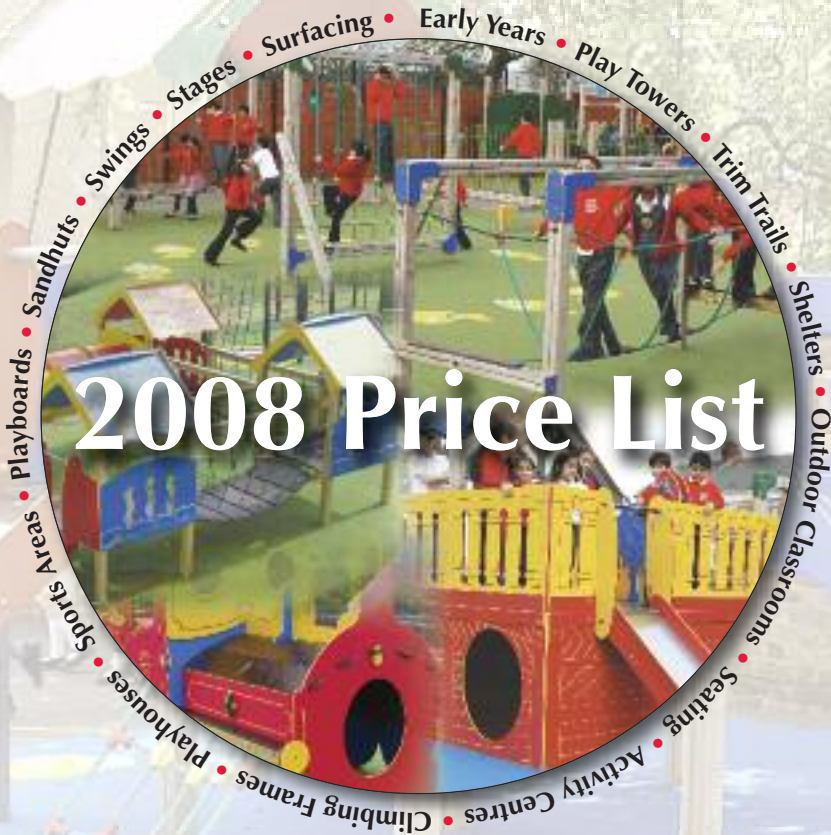

2008 Price List

For further information contact



PO Box 707

Mold, Flintshire, CH7 1FG

Tel: 01244 375627 • Fax: 01244 374990

Email: sales@creativeplayuk.com • Website: www.creativeplayuk.com



Contents

	Age Range	Page No.
Lilliput Playtown Range	2-5 years	1-2
Daisy Tower Range	2-5 years	3-4
Playhouse Range	2-7 years	4-5
Voyager Range	2-12 years	5-7
Sandboxes and Sandhuts		8
Outdoor Stage Areas		8
Playboards and Wall Panels		9-12
Challenger Trim Trails / Challenger Range		13-21
Zenith Tower / Zenith Max Tower Range	5-12 years	22-26
Activity Centres	5-12 years	26-27
Climbing Frames		28
Swings, Springs and Things		29-31
Seating, Shades, Shelters & Outdoor Classrooms		32-34
Playground Surfacing & Fencing		36
Multi-Use Games Areas		35
Specification of Materials		37

Specification of Materials



Timber

- We use selected first grade timber from sustainable commercial plantations with at least 70% sourced from forests independently certified under the Forest Stewardship Council.
- Timbers are cut free of the heart of the log and square sawn with chamfered edges.
- All timbers are pressure impregnated with a chrome and arsenic free preservative which protects against decay and insect attack for 20 years.
- Horizontal timbers are secured on top of uprights by way of custom made brackets to maximise the load bearing capacity.
- All end grain is capped to prevent moisture entering exposed uprights, as well as cover rough end grain.

Steel

- Hot dip galvanised or
- Shot blasted, etched and electro-statically powder coated to EN 45011.

Panels and Roofs

- High density self-coloured polyethylene panels or
- Half machine rounded timber secured to steel frame.

Floors and Ramps

- Birch plywood exterior panels impregnated with dense rough wire mesh pattern to give a slip-resistant finish.

Ropes and Nets

- Multi-filament steel core ropes secured with hydraulically pressed end connections and custom made tamper-proof net joins.

Chains

- Small link galvanised chain.

Springs

- Coil designed not to compress and cause entrapment under load.

Fastenings

- Tamper-proof recessed mushroom head bolt, which do not require capping.

Swing Seats

- Rubber, with honeycomb construction sides for maximum impact absorption.

Construction

- Foundation for uprights 750mm deep and uprights secured in concrete block 6000mm x 400mm.

Guarantees

Timbers

- 20 years against structural failure caused by rot or insect infestation.

Panels, Roofs, Slide Sides and Themed Play Products

- 5 years against structural failure.

Platforms, Floors and Footholds

- 5 years against structural failure.

Chains, Coupling Links and Shackles

- 5 years against structural failure.

Ropes, Nets, Rope Bridges and Rope Pulls

- 3 years against structural failure.

Bolts and Security Fastenings

- 10 years against structural failure.

Springs

- 5 years against structural failure.

Playsafe Surfacing

- 5 years normal use.

Installation and Site Work

- 2 years against faulty workmanship and defective materials. (Problems arising as a result of soil erosion or subsidence are not covered).

Maintenance

We recommend that all equipment be inspected on a regular basis — this can be carried out internally — frequency depending upon level of usage. We also recommend that a detailed check and service be carried out annually. We can offer an annual fixed price check. Contact our customer services department for any further information.

After Sales Service

We have a dedicated service department to deal with all maintenance requirements, including supply of spares from our comprehensive stock, on site maintenance, inspection and servicing of equipment.

We reserve the right to change the specification and design of products without notice.

All equipment and surfacing is designed, manufactured and installed to comply with requirements of BS EN 1176 & 1177.

Tel: 01244 375627 • Fax: 01244 374990
Email: sales@creativeplayuk.com • Web: www.creativeplayuk.com

Playground Surfacing and Fencing - Brochure Page 37

Surfacing Requirements

Impact absorbing surfaces should be used where the free height of fall of equipment is over 600mm. Top soil or turf may be used up to 1m providing the surface is well maintained.

Whilst impact absorbing surface is not required where the free height of fall of equipment is 600mm or less, it is recommended that a surface with impact attenuating qualities be used.

Area Requirements

The area requirements as set out in EN 1176 are shown by each item of equipment in this price list. There are no area requirements for 600mm or less, but we suggest 1m minimum.

Types of Impact Absorbing Surface Synthetic Surface

Playsafe - Outdoor sports surface tested for compliance with the requirements of EN1177.

Types of Impact Absorbing Surface Synthetic Surface

Playsafe - Outdoor sports surface tested for compliance with the requirements of EN1177. Can be used to combat soil erosion or with the addition of impact absorbing material as a safer surfacing. It is not as heavy as rubber and can often be installed onto grass or top soil without the need for an expensive base. The surface is softer than rubber and falls are less likely to result in friction burns.

Includes rubber wet pour or tiles, artificial grass, outdoor carpet or mats. The specification and cost is dependent on the free height of fall of the equipment and the ground preparation required.

Rubber Wet Pour and Tiles - Installed on a prepared hardcore or concrete base. It is sometimes possible to use existing concrete or tarmac as a base. Rubber wet pour is prepared and mixed on site.

Loose Fill

Materials commonly used include bark, wood chip, sand or gravel. As a guide a

minimum depth of 300mm is required. Whilst the initial cost of loose fill is often less than synthetic surfacing the maintenance costs are higher as regular raking, cleaning and topping up is required. Loose fill areas can also become water logged inhibiting the use of areas.

Cost of Surfacing

The cost of surfacing depends upon the free height of fall of the equipment and on the amount of site preparation required, which can vary enormously from site to site. As a guide Playsafe for free heights of fall to 1m from £39m² installed on a hard surface to £50m² installed on grass or top soil compared with wet pour on a prepared base from £39m² to £100m² plus including base preparation.

We recommend Playsafe surfacing as the perfect compliment to **Creative Play** equipment.

Available in blue, green, yellow, red and terracotta, this versatile surface can be used on grass, topsoil or existing hard surfaces such as tarmac or concrete.

Tested to British Standard BS EN 1177, it provides a hard-wearing, all-weather surface and can brighten up any play area. You can include an inlaid design such as hopscotch, alphabet snake or stars to increase the play value of your surface and cheer up your area.

Our play advisors will be happy to advise you on the range of designs which can be incorporated into Playsafe Surfacing.





We can also supply fencing, planters, and signs.

Impact absorbing surfaces should be used where the free height of fall of equipment is over 600mm. Top soil or turf may be used up to 1m providing the surface is well maintained.

Whilst impact absorbing surface is not required where the free height of fall of equipment is 600mm or less, it is recommended that a surface with impact attenuating qualities be used.

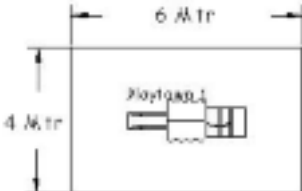

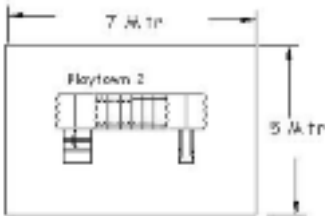

Lilliput Playtowns

Product Code	Item	Brochure Page	Specification	Cost (exc vat)
L110	 <p>Ramp with rope pull Slide 1 Tower</p>	1-2	<p>Equipment height : 2.4m Free height of fall : 60cm Operating area : 24m² <i>Safer surfacing not required.</i> <i>If installed on tarmac or concrete - surface with attenuating qualities recommended.</i></p> 	£ 2,996
L109	 <p>Ramp with rope pull Slide Clatterbridge 2 Towers</p>	1-2	<p>Equipment height : 2.4m Free height of fall : 60cm Operating area : 35m² <i>Safer surfacing not required.</i> <i>If installed on tarmac or concrete - surface with attenuating qualities recommended.</i></p> 	£ 4,858
L108	 <p>Ramp with rope pull Slide Vertical climbing panel Clatterbridge Crawling tube 3 towers</p>	1-2	<p>Equipment height : 2.4m Free height of fall : 60cm Operating area : 48m² <i>Safer surfacing not required.</i> <i>If installed on tarmac or concrete - surface with attenuating qualities recommended.</i></p> 	£ 8,772

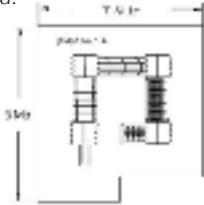
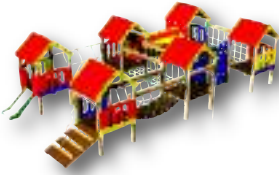
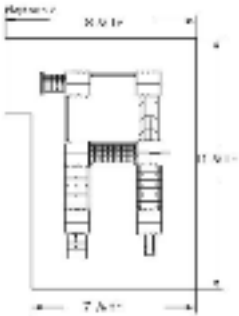

Delivery & installation included UK mainland on orders over £1,000 exc vat.
Orders less than £1,000 exc vat, add 20% for delivery & installation.

Lilliput Playtowns

Product Code	Item	Brochure Page	Specification	Cost (exc vat)
L107	<p>Lilliput Playtown Four</p>  <p>Net to platform Crawling tube Net tunnel Slide Clatterbridge 4 towers</p>	1-2	<p>Equipment height : 2.4m Free height of fall : 60cm Operating area : 52.5m² <i>Safer surfacing not required.</i> <i>If installed on tarmac or concrete - surface with attenuating qualities recommended.</i></p> 	£ 10,994
L106	<p>Lilliput Playtown Six</p>  <p>Clatterbridge Crawling tube Net traverse Rock traverse Net tunnel Rope bridge Ramp with rope pull Slide Firefighters pole Scramble net 6 towers</p>	1-2	<p>Equipment height : 2.4m Free height of fall : 60cm Operating area : 80.5m² <i>Safer surfacing not required.</i> <i>If installed on tarmac or concrete - surface with attenuating qualities recommended.</i></p> 	£ 14,998
L110	<p>Lilliput Playtown Rustic</p> 	1-2	<p>All Lilliput Playtown roofs can be made of half rounded timbers to give a more rustic country look. Ideal for woodland or environmentally sensitive settings.</p>	

Delivery & installation included UK mainland on orders over £1,000 exc vat.
Orders less than £1,000 exc vat, add 20% for delivery & installation.

Multi-Use Games Area - M.U.G.A

Product Code	Item	Brochure Page	Specification	Cost (exc vat)
GE1	<p style="text-align: center;">Goal Ends</p> 	39	Available in Round or Square Steel Tube with timber wings	From £ 4,011
MUGA1	<p style="text-align: center;">MUGA</p> 	39	Available in 12 x 22m 15 x 30m 18 x 36m with a choice of surface and markings.	Price on application

For more information on MUGA's
Please call one of our **Sales Advisors on 01244 375627**.

Combi Goal Range

Product Code	Item	Brochure Page	Specification	Cost (exc vat)
	<p style="text-align: center;">Combi Goal</p> 			

Delivery & installation included UK mainland on orders over £1,000 exc vat.
Orders less than £1,000 exc vat, add 20% for delivery & installation.

Seating, Shades, Shelters and Outdoor Classrooms

Product Code	Item	Brochure Page	Specification	Cost (exc vat)
BT100	Big Top 	33-36	4 metre, 5 metre or 6 metre diameter. Sails available pvc coated materials.	4 metre £ 3,258 5 metre £ 3,547 6 metre £ 3,836
OC104	Oxford Shelter 	33-36	425mm x 3m With integral planters, benches and twin wall polycarbonate roof.	£ 5,872
OC101	Lichfield Shelter 	33-36	3m x 3m With integral planters and bench.	£ 3,550
OC103	Cambridge Shelter 	33-36	3m x 3m With integral planters, benches and twin wall polycarbonate roof.	£ 4,957
OC102	Canterbury Shelter 	33-36	3m x 3m With integral planters and bench.	£ 4,609

Delivery & installation included UK mainland on orders over £1,000 exc vat.
 Orders less than £1,000 exc vat, add 20% for delivery & installation.

Daisy Tower Range

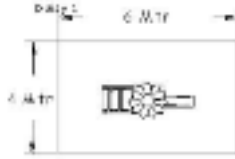
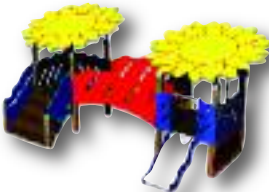
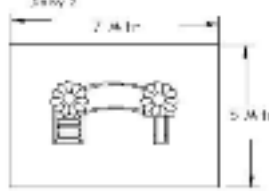
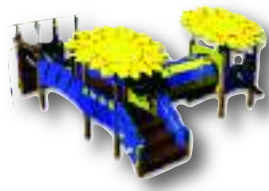
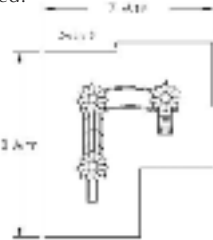
Product Code	Item	Brochure Page	Specification	Cost (exc vat)
D110	<p style="text-align: center;">Daisy One</p>  <p>Slide Stairs with hand ropes 1 tower</p>	3-4	<p>Equipment height : 2.4m Free height of fall : 60cm Operating area : 24m² <i>Safer surfacing not required.</i> <i>If installed on tarmac or concrete - surface with attenuating qualities recommended.</i></p> 	£ 3,096
D109	<p style="text-align: center;">Daisy Two</p>  <p>Slide Stairs with hand rope Arched walkway Playboard Firefighters pole 2 towers</p>	3-4	<p>Equipment height : 2.4m Free height of fall : 60cm Operating area : 35m² <i>Safer surfacing not required.</i> <i>If installed on tarmac or concrete - surface with attenuating qualities recommended.</i></p> 	£ 6,542
D108	<p style="text-align: center;">Daisy Three</p>  <p>Crawling tube Playboard Arched ladder Slide Arched walkway Firefighter's pole Rock climber 3 towers</p>	3-4	<p>Equipment height : 2.4m Free height of fall : 60cm Operating area : 49m² <i>Safer surfacing not required.</i> <i>If installed on tarmac or concrete - surface with attenuating qualities recommended.</i></p> 	£ 9,981

Delivery & installation included UK mainland on orders over £1,000 exc vat.
Orders less than £1,000 exc vat, add 20% for delivery & installation.

Daisy Tower Range

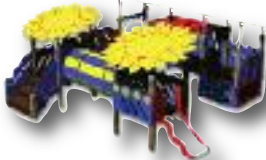
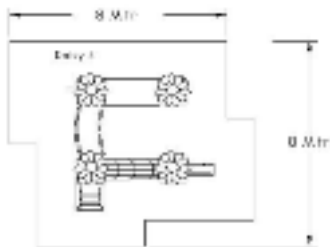

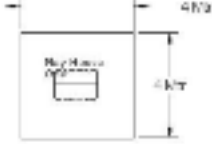
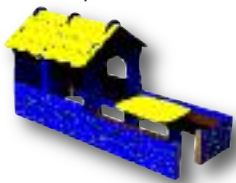
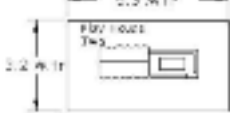

Product Code	Item	Brochure Page	Specification	Cost (exc vat)
D107	<p style="text-align: center;">Daisy Four</p>  <p>Arched walkway Crawling tube Rock climber Firefighters pole Slide Covered walkway Stairs with hand rope Playboard 4 towers</p>	3-4	<p>Equipment height : 2.4m Free height of fall : 60cm Operating area : 61m² <i>Safer surfacing not required.</i> <i>If installed on tarmac or concrete surface with attenuating qualities recommended.</i></p> 	£ 13,220

Playhouse Range

Product Code	Item	Brochure Page	Specification	Cost (exc vat)
L111	<p style="text-align: center;">Playhouse One</p>  <p>Covered Seating Windows</p>	5-6	<p>Equipment height : 1.5m Equipment width : 1.3m Equipment length : 1.5m Operating area : 11.55m²</p> 	£ 1,092
L119	<p style="text-align: center;">Playhouse Two</p>  <p>Covered Seating Windows Outdoor seating with table</p>	5-6	<p>Equipment height : 1.55m Equipment length : 3.9m Equipment width : 1.95m Seat height : 35cm Operating area : 16.6m²</p> 	£ 2,425

Delivery & installation included UK mainland on orders over £1,000 exc vat.
Orders less than £1,000 exc vat, add 20% for delivery & installation.

Seating, Shades, Shelters and Outdoor Classrooms

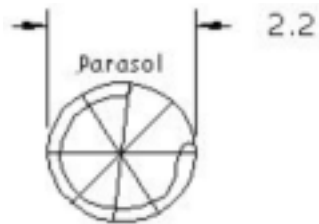
Product Code	Item	Brochure Page	Specification	Cost (exc vat)
FB101	Friendship Bench 	33-36	Seating height: 40cm Overall height: 1.5m (approx) Length: 2.3m Depth: 27.5cm	£ 634
PL101	Timber Planter and Seat 	33-36	1 x planter and 1 x seat	£ 606
PL101	Timber Planter 	33-36	Width : 49cm Length : 1.89m	£ 485
PT101	Picnic Bench 	33-36	Seating height : 40cm Table height : 65cm	£ 463
VW101	Parasol Bench 	33-36	Overall height : 2.4m Seating height : 50cm 	£ 2,998

Delivery & installation included UK mainland on orders over £1,000 exc vat.
 Orders less than £1,000 exc vat, add 20% for delivery & installation.

Seating, Shades, Shelters and Outdoor Classrooms



Product Code	Item	Brochure Page	Specification	Cost (exc vat)
AB103	Hedgehog Bench 	33-36	Seating Height : 50cm Length : 1.2m.	£ 273
AB104	Frog Bench 	33-36	Seating Height : 50cm Length : 1.2m.	£ 273
AB102	Pony Bench 	33-36	Seating Height : 50cm Length : 1.2m.	£ 273
TRS101	Tree Bench 	33-36	Seating Height : 40cm	£ 598
BS101	Bench Seat 	33-36	Seating height: 40cm Overall height: 85cm Length: 1.25m Depth: 55cm	£ 430

Delivery & installation included UK mainland on orders over £1,000 exc vat.
Orders less than £1,000 exc vat, add 20% for delivery & installation.

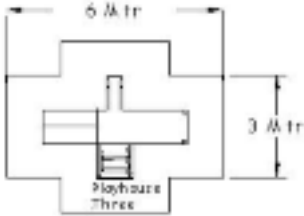
Playhouse Range



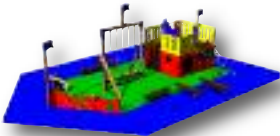
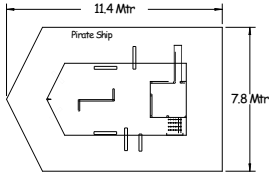

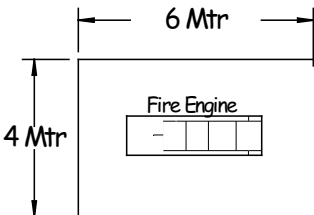
Product Code	Item	Brochure Page	Specification	Cost (exc vat)
L111	<p style="text-align: center;">Playhouse Three</p>  <p>Steps Covered seating Slide 1 tower 4 play panels - (double sided chalk board, 2 x compass, 2 x clock, alphabet slider).</p>	5-6	<p>Equipment height : 2.2m Equipment width : 2.89m Equipment length : 3.88m Free height of fall :60cm Operating area : 36m²</p> 	£ 5,399

The Voyager Range

Product Code	Item	Brochure Page	Specification	Cost (exc vat)
VOY101	<p style="text-align: center;">Pirate Ship</p> 	7-10	<p>Equipment Height: 2.3m Free height of fall : 1m Operating area : 88m² <i>Safer surfacing required.</i> <i>Grass or top soil can be used providing well maintained.</i></p> 	£ 12,768 including Playsafe Surfacing
VOY104	<p style="text-align: center;">Fire Engine</p> 	7-10	<p>Operating area : 24m²</p> 	£ 4,168

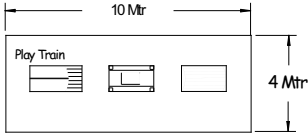

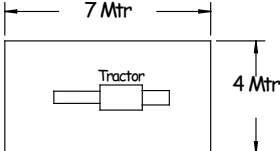
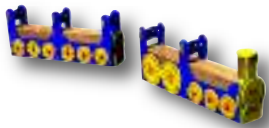
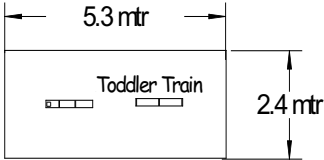
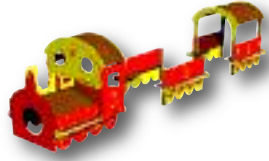



Delivery & installation included UK mainland on orders over £1,000 exc vat.
Orders less than £1,000 exc vat, add 20% for delivery & installation.

The Voyager Range

Product Code	Item	Brochure Page	Specification	Cost (exc vat)
VOY102	Play Train 	7-10	Equipment Height: 2m Free height of fall : 50cm Operating area : 29.6m ² <i>Safer surfacing not required.</i> <i>If installed on tarmac or concrete - surface with attenuating qualities recommended.</i> 	(Set of 3) £ 8,905 Engine £ 3,932 Carriage £ 2,977 Wagon £ 1,996
VOY103	Tractor 	7-10	Free height of fall : 1m Operating area : 28m ² <i>Safer surfacing required.</i> <i>Grass or top soil can be used providing well maintained.</i> 	£ 4,634
TD100	Toddler Train 	7-10	Each Carriage : 1.2m Seat height : 25cm Suitable for nursery age group. 	£ 1,433 Full set - Engine & Carriage
VOY1020	Mini Train 	7-10	Free height of fall : 40cm Operating area : 24m ² <i>Safer surfacing required.</i> <i>Grass or top soil can be used providing well maintained.</i> 	Full set £ 4,399 Engine £ 1,698 Carriage £ 1,719 Wagon £ 987



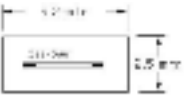

Delivery & installation included UK mainland on orders over £1,000 exc vat.
 Orders less than £1,000 exc vat, add 20% for delivery & installation.

Swings, Springs and Things

Product Code	Item	Brochure Page	Specification	Cost (exc vat)
SR105	Double Plane Spring Rider 	31-32	Height : 75cm Safer surfacing required.	£ 669
SR101	Double Car Spring Rider 	31-32	Height : 75cm Safer surfacing required.	£ 669
S107	Tyre Stack Minor (2 tyres) 	31-32	Equipment Height: 1m Free height of fall: 1m Operating area : 23.5m ² <i>Safer surfacing required.</i> <i>Grass or top soil can be used providing well maintained.</i>	£ 308
S108	Tyre Stack Minor (3 tyres) 	31-32	Equipment Height: 1.7m Free height of fall: 1.7m Operating area : 50.2m ² <i>Safer surfacing required.</i>	£ 460
SR109	Seesaw 	31-32	Equipment Height: 80cm Free height of fall: 50cm Operating area : 13m ² <i>Safer surfacing required.</i> 	£ 959
SR1010	Seesaw 	31-32	Equipment Height: 90cm Free height of fall: 50cm Operating area : 13m ² <i>Safer surfacing required.</i> 	£ 1,035



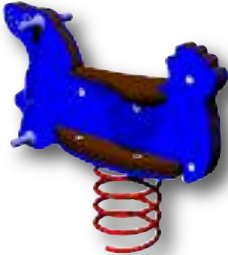

Delivery & installation included UK mainland on orders over £1,000 exc vat.
 Orders less than £1,000 exc vat, add 20% for delivery & installation.

Swings, Springs and Things

Product Code	Item	Brochure Page	Specification	Cost (exc vat)
SR102	Duck Spring Rider 	31-32	Height : 75cm Width : 24cm Length : 80cm Free height of fall: 57cm Operating area : 6.3m ²	£ 549
SR101	Rabbit Spring Rider 	31-32	Height : 75cm Width : 24cm Length : 80cm Free height of fall: 57cm Operating area : 6.3m ²	£ 549
SR101	Seal Rider 	31-32	Height : 75cm Width : 24cm Length : 80cm Free height of fall: 57cm Operating area : 6.3m ²	£ 549
SR104	Motorbike Rider 	31-32	Height : 75cm Width : 24cm Length : 80cm Free height of fall: 57cm Operating area : 6.3m ²	£ 549

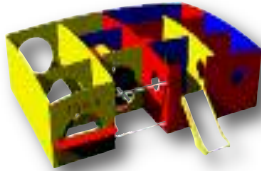
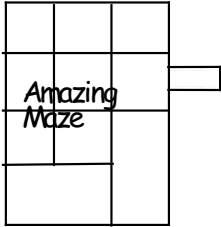

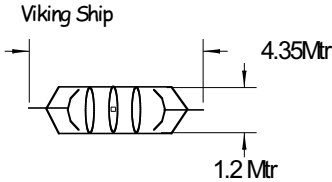

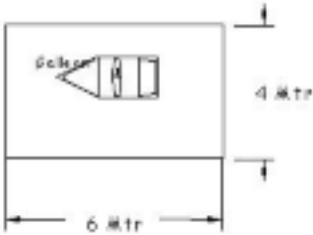
Delivery & installation included UK mainland on orders over £1,000 exc vat.
 Orders less than £1,000 exc vat, add 20% for delivery & installation.

The Voyager Range

Product Code	Item	Brochure Page	Specification	Cost (exc vat)
VOY108	Amazing Maze (9 Rooms) 	7-10	Height : 1.5m Free fall height : 60cm Operating area : 33m ² <i>Safer surfacing not required.</i> 	£ 8,971
VOY105	Viking Ship 	7-10	Overall Height : 2.3m Operating area : 20.32m ² 	£ 3,693
VOY106	Galleon 	7-10	Overall Height : 1.8m Free height of fall : 60cm Operating area : 15.6m ² 	£ 2,285

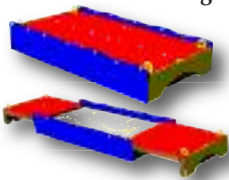
Delivery & installation included UK mainland on orders over £1,000 exc vat.
 Orders less than £1,000 exc vat, add 20% for delivery & installation.

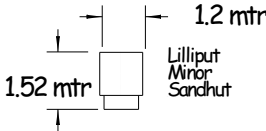
Sandboxes and Sandhuts

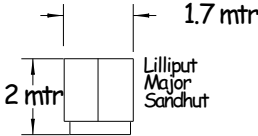

Product Code	Item	Brochure Page	Specification	Cost (exc vat)
SB101	Sandbox with sliding lid 	11	Height : 40cm Length : 2.4m (when closed) Width : 1.15m Length : 5.4m (needed when open)	£ 1,088
SB102	Lilliput Minor Sand Hut 	11	Overall height : 2.1m to top of roof Platform height: 36.5cm 	£ 1,636
SB103	Lilliput Major Sand Hut 	11	Overall height : 2.1m to top of roof Platform height: 36.5cm 	£ 3,196

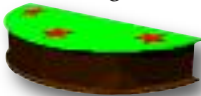
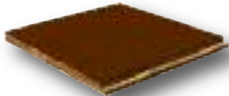
Outdoor Stage Areas

Product Code	Item	Brochure Page	Specification	Cost (exc vat)
TS102	Stage with Curtain effect 	12	Equipment height : 40cm Platform height : 2.4m Length : 3m Depth : 1.98m	£ 3,219
TS101	Stage 	12	Equipment height : 48cm Length : 3m Depth : 1.98m	£ 3,079
TS103	Tap Stage 	12	Stage height : 28cm other sizes on application	4x3mtr £ 4,468 5x3mtr £ 6,998 6x3mtr £ 8,138

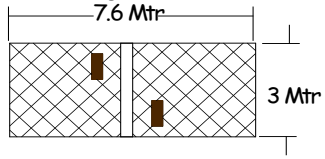

Delivery & installation included UK mainland on orders over £1,000 exc vat.
 Orders less than £1,000 exc vat, add 20% for delivery & installation.

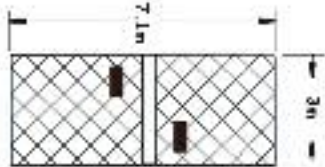
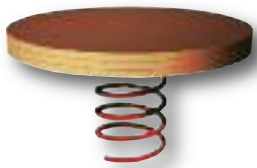
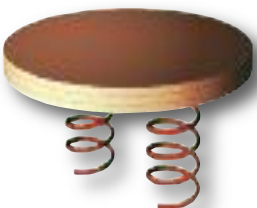
Swings, Springs and Things

Product Code	Item	Brochure Page	Specification	Cost (exc vat)
S101	<p>Double Swing with flat seats</p> 	31-32	<p>Equipment Height : 2.5m Width : 3m Operating area : 27m² Free height of fall : 1.4m <i>Safer surfacing not required.</i></p> <p style="text-align: center;">Double Flat Swings</p> 	£ 1,041
S102	<p>Double Swing with cradle seats</p> 	31-32	<p>Equipment height: 2.5m Length : 7.1 Width : 3m Free height of fall : 1.4m Operating area : 21.3m² <i>Safer surfacing required.</i></p> 	£ 1,248
S105	<p>Springer Minor</p> 	n/a	<p>Equipment height: 30cm Free height of fall : 30cm Operating area : 16.3m² <i>Safer surfacing not required.</i> If installed on tarmac or concrete - surface with attenuating qualities recommended.</p>	£ 489
S105	<p>Springer Minor</p> 	n/a	<p>Equipment height: 30cm Free height of fall : 30cm Operating area : 16.3m² <i>Safer surfacing not required.</i> If installed on tarmac or concrete - surface with attenuating qualities recommended.</p>	£ 988

Delivery & installation included UK mainland on orders over £1,000 exc vat.
 Orders less than £1,000 exc vat, add 20% for delivery & installation.

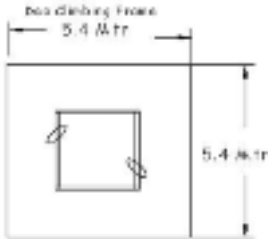
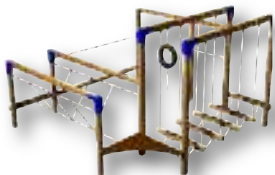
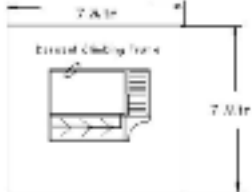
Climbing Frames

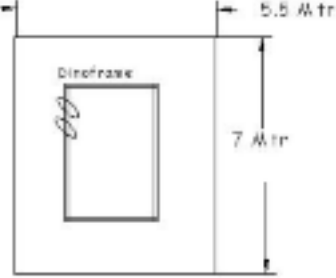
Product Code	Item	Brochure Page	Specification	Cost (exc vat)
C101	<p>Dee Climbing Frame</p>  <p>Net crossing Tyre swing fixed to the ground x 2 Agility bar x 2 Log climber</p>	28	<p>Equipment height : 2.3m Free height of fall : 1m Operating area : 31.36m² <i>Safer surfacing required.</i> <i>Grass or top soil can be used providing well maintained.</i></p> 	£ 2,211
CF102	<p>Derwent Climbing Frame</p>  <p>Rope bridge Log crossing Agility bar Tyre swing fixed to the ground</p>	28	<p>Equipment height : 2.3m Free height of fall : 1m Operating area : 49m² <i>Safer surfacing not required.</i> <i>If installed on tarmac or concrete surface with attenuating qualities recommended</i></p> 	£ 2,411
CF103	<p>Dino-Frame</p>  <p>Net crossing Agility bar Tyre swing fixed to the ground x 2 Rope crossing Log climber</p>	28	<p>Height : 1.5m Free fall height : 1m Operating area : 38.5m² <i>Safer surfacing required.</i></p> 	£ 2,652





Delivery & installation included UK mainland on orders over £1,000 exc vat.
Orders less than £1,000 exc vat, add 20% for delivery & installation.

Playboards and Play Panels

Product Code	Item	Brochure Page	Specification	Cost (exc vat)
PB101	Chalk Board 	13-14	Panel height : 85cm Panel width : 1.17m On Stilts Height : 1.2m Width : 1.17m	£ 521
PB102	Animal Abacus 	13-14	Panel height : 1.12m Panel width : 1.17m On Stilts Height : 1.2m Width : 1.17m	£ 833
PB103	Shop Front 	13-14	Panel height : 1.5m Panel width : 1.15m	£ 598
PB104	Whizzwheel 	13-14	Panel height : 85cm Panel width : 1.17m On Stilts Height : 1.2m Width : 1.17m	£ 521
PB105	Funky Mirror 	13-14	Panel height : 78cm Panel width : 1.17m On Stilts Height : 1.2m Width : 1.17m	£ 521

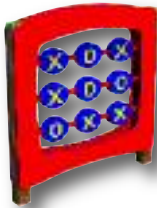

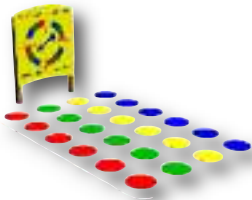

Delivery & installation included UK mainland on orders over £1,000 exc vat.
 Orders less than £1,000 exc vat, add 20% for delivery & installation.

Playboards and Play Panels

Product Code	Item	Brochure Page	Specification	Cost (exc vat)
PB106	Noughts & Crosses 	13-14	Panel height : 85cm Panel width : 1.17m On Stilts Height : 1.2m Width : 1.17m	£ 761
PB107	Basket Ball & Target 	13-14	On Stilts Height : 2.4m Width : 60cm	£ 512
PB108	Musical Chimes 	13-14	Panel height : 1.19m Panel width : 99cm On Stilts Height : 1.5m Width : 99cm	£ 671
PB109	Twirler 	13-14	Includes Playsafe mat 4m x 2m	£ 2,743
WP101	Clock Wall Panel 	13-14	Panel height : 1.18m Panel width : 78cm	£ 624

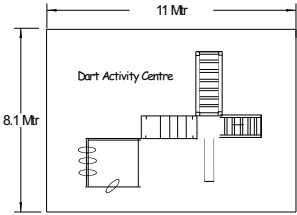
Delivery & installation included UK mainland on orders over £1,000 exc vat.
 Orders less than £1,000 exc vat, add 20% for delivery & installation.

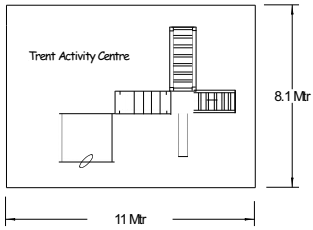
Activity Centres

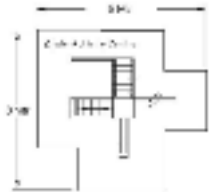
Product Code	Item	Brochure Page	Specification	Cost (exc vat)
AC101	<p style="text-align: center;">Dart Activity Centre</p>  <p>Ramp with rope pull Vertical climbing panel Net crossing Slide Clatterbridge Tyre swing Log crossing Tyre crossing Agility bar</p>	29-30	<p>Equipment height : 2.3m Free height of fall : 1m Operating area : 62m² <i>Safer surfacing required.</i> <i>Grass or top soil can be used providing well maintained</i></p> 	<p>£ 5,259</p> <p>£ 5,684 (with roof)</p>
AC102	<p style="text-align: center;">Trent Activity Centre</p>  <p>Ramp with rope pull Vertical climbing panel Log climber x 2 Slide Clatterbridge Tyre swing Log crossing Combination net Agility bar</p>	29-30	<p>Equipment height : 2.3m Free height of fall : 2m Operating area : 69m² <i>Safer surfacing required.</i></p> 	<p>£ 5,358</p> <p>£ 5,789 (with roof)</p>
AC103	<p style="text-align: center;">Clyde Activity Centre</p>  <p>Ramp with rope pull Slide Vertical climbing panel Net crossing Clatterbridge Tyre swing Log climber</p>	29-30	<p>Equipment height : 2.3m Free height of fall : 1m Operating area : 50m² <i>Safer surfacing required.</i> <i>Grass or top soil can be used providing well maintained</i></p> 	<p>£ 3,978</p> <p>£ 4,406 (with roof)</p>

Delivery & installation included UK mainland on orders over £1,000 exc vat.
Orders less than £1,000 exc vat, add 20% for delivery & installation.

Zenith Max Tower Range

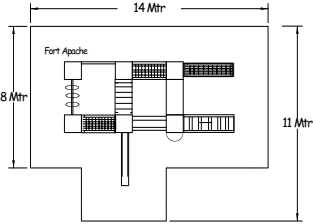
Product Code	Item	Brochure Page	Specification	Cost (exc vat)
ZM107	<p style="text-align: center;">Fort Apache</p>  <p>Speaking tube Fixed ramp with rope pull Crawling tube Rock traverse Net tunnel Rop bridge Net traverse Clatterbridge Slide Net climber Rope stairway Firefighters pole Play panels Tyre crossing 6 towers</p>	23-27	<p>Equipment height : 3m Width : 7m Length : 10m Free height of fall : 2m Operating Area : 127m² <i>Safer surfacing required.</i></p> 	£ 21,954

Activity Centres

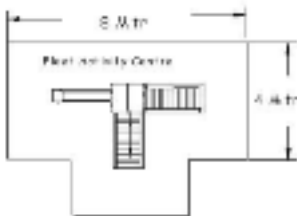
Product Code	Item	Brochure Page	Specification	Cost (exc vat)
AC105	<p style="text-align: center;">Fleet Activity Centre</p>  <p>Ramp with rope pull Slide Log crossing Vertical climbing panel Roof</p>	29-30	<p>Equipment height : 3m Free height of fall : 1m Operating area : 40m² <i>Safer surfacing required.</i> <i>Grass or top soil can be used providing well maintained</i></p> 	£ 3,742





Delivery & installation included UK mainland on orders over £1,000 exc vat.
Orders less than £1,000 exc vat, add 20% for delivery & installation.

Playboards and Play Panels

Product Code	Item	Brochure Page	Specification	Cost (exc vat)
WP102	Compass 	13-14	Panel height : 1.8m Panel width : 78cm	£ 584
WP103	Numbers 1 to 10 	13-14	Panel height : 1.8m Panel width : 78cm	£ 142
WP104	Cricket Stumps 	13-14	Panel Height : 90cm Panel Width : 35cm	£ 105
WP105	Four Seasons 	13-14	Panel Height : 1.18m Panel Width : 78cm	£ 142
WP106	Shapes Wall Panel 	13-14	Panel Height : 78cm Panel Width : 1.18m	£ 142

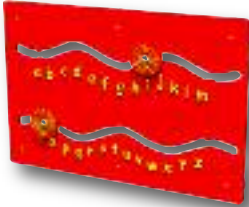



Delivery & installation included UK mainland on orders over £1,000 exc vat.
 Orders less than £1,000 exc vat, add 20% for delivery & installation.

Playboards and Play Panels

Product Code	Item	Brochure Page	Specification	Cost (exc vat)
WP107	Alphabet Slider 	13-14	Panel height : 78cm Panel width : 1.18m	£ 657
WP108	Measure Me 	13-14	Panel height : 1.8m Panel width : 40cm	£ 127
WP111	Alphabet Snake 	13-14	Panel Height : 90cm Panel Width : 35cm	£ 133
WP105	Four Seasons 	13-14	Panel Height : 1.18m Panel Width : 78cm	£ 880

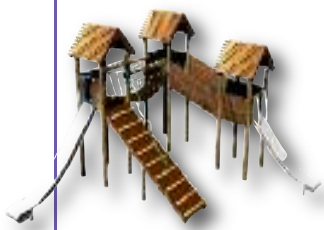
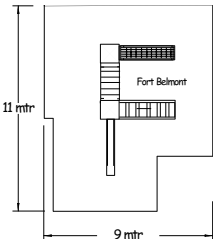

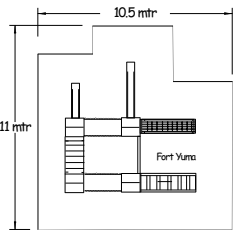

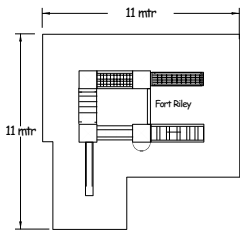
Delivery & installation included UK mainland on orders over £1,000 exc vat.
 Orders less than £1,000 exc vat, add 20% for delivery & installation.

Zenith Max Tower Range

Product Code	Item	Brochure Page	Specification	Cost (exc vat)
ZM104	<p>Fort Licoln</p>  <p>2 ramps 2 slides 3 towers Clatterbridge 2 levels Choice of roof designs</p>	23-27	<p>Equipment height : 3.5m Width : 6m Length : 7m Free height of fall : 1.5 & 2m <i>Safer surfacing required.</i></p> 	£ 12,845
ZM105	<p>Fort Yuma</p>  <p>2 slides 3 ramps 4 towers Net traverse Clatterbridge Different levels, Fort front design Choice of roof designs.</p>	23-27	<p>Equipment height : 3.5m Width : 7m Length : 7m Free height of fall : 1.5 & 2m <i>Safer surfacing required.</i></p> 	£ 14,856
ZM106	<p>Fort Riley</p>  <p>Ramp, Slide 4 towers, Net traverse Fort front design Choice of roof designs Seating under towers Crawling tube, Rope bridge Climbing net Firefighters pole</p>	23-27	<p>Equipment height : 3.5m Width : 7m Length : 7m Free height of fall : 2m <i>Safer surfacing required.</i></p> 	£ 13,939

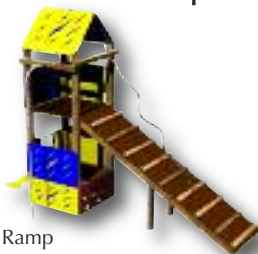
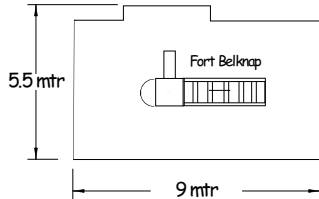
Delivery & installation included UK mainland on orders over £1,000 exc vat.
Orders less than £1,000 exc vat, add 20% for delivery & installation.

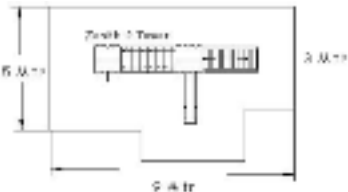
Zenith Max Tower Range

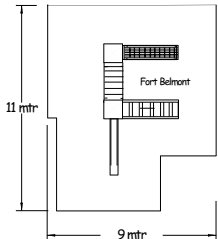
Product Code	Item	Brochure Page	Specification	Cost (exc vat)
ZM101	<p style="text-align: center;">Fort Belknop</p>  <p>Ramp Firefighters pole Slide Two levels Lightening design on roof and Panels</p>	23-27	<p>Equipment height : 3.5m Width : 2m Length : 4.5m Free height of fall : 60mm & 2m <i>Safer surfacing required.</i></p> 	£ 4,823
ZM102	<p style="text-align: center;">Fort Leavenworth</p>  <p>Slide Net to platform Net traverse 1 tower</p>	23-27	<p>Equipment height : 3.5m Width : 3m Length : 6m Free height of fall : 2m <i>Safer surfacing required.</i></p> 	£ 5,650
ZM103	<p style="text-align: center;">Fort Belmont</p>  <p>Ramp Slide 2 towers Net traverse Clatterbridge Choice of roof designs</p>	23-27	<p>Equipment height : 3.5m Width : 4m Length : 7m Free height of fall : 2m <i>Safer surfacing required.</i></p> 	£ 8,608

Delivery & installation included UK mainland on orders over £1,000 exc vat.
Orders less than £1,000 exc vat, add 20% for delivery & installation.

Challenger Trim Trails

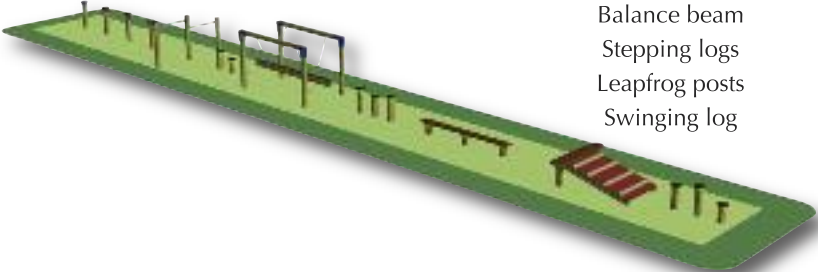
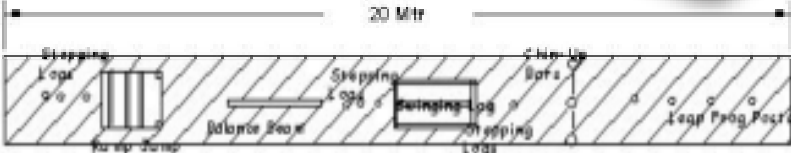
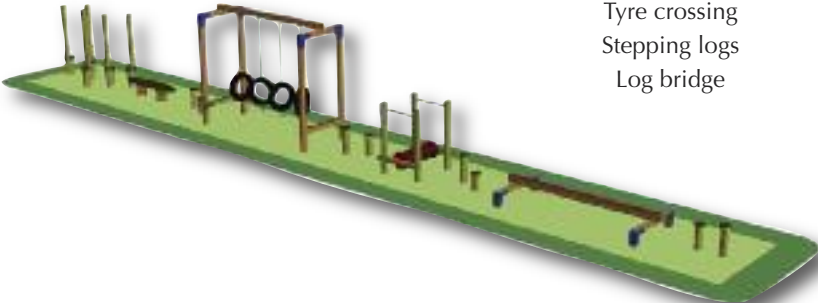
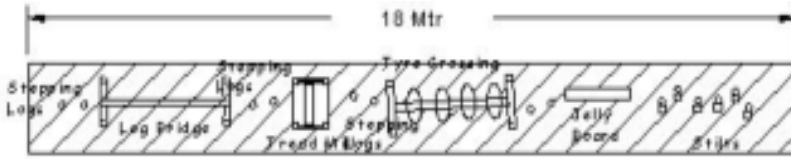
Item	Brochure Page	Specification	Cost (exc vat)
<p>Hudson Trail</p>  	15-18	Chin-up bars Ramp jump Balance beam Stepping logs Leapfrog posts Swinging log	Equipment Supplied and Installed £ 2,046 Complete with Playsafe on Grass £ 4,086 Complete with Playsafe on Tarmac £ 5,326
<p>Item</p>	<p>Brochure Page</p>	<p>Specification</p>	<p>Cost (exc vat)</p>
<p>Yukon Trail</p>  	15-18	Jelly board Tread mill Stilts Tyre crossing Stepping logs Log bridge	Equipment Supplied and Installed £ 3,383 Complete with Playsafe on Grass £ 5,219 Complete with Playsafe on Tarmac £ 6,335



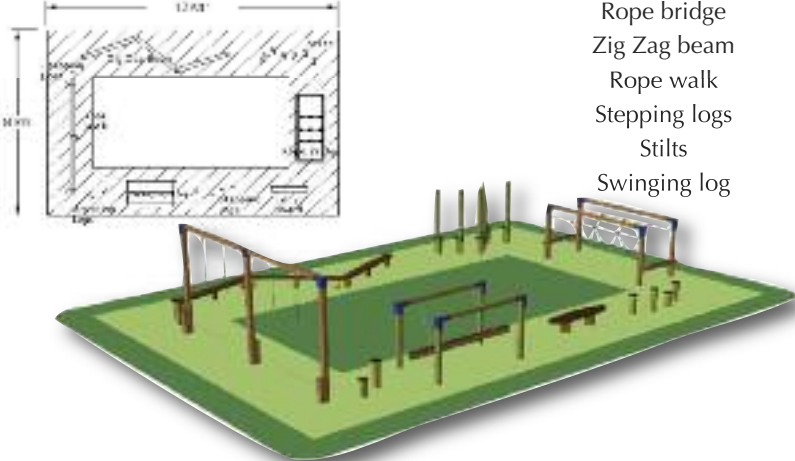
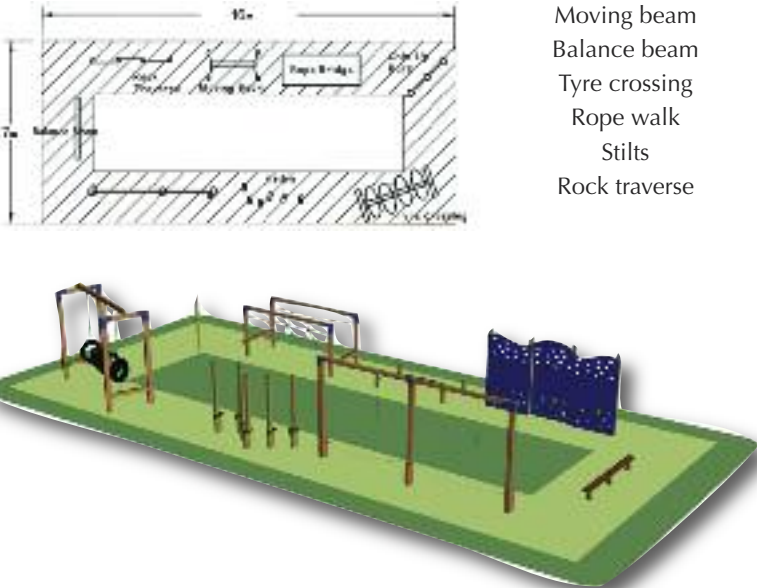

Delivery & installation included UK mainland on orders over £1,000 exc vat.
 Orders less than £1,000 exc vat, add 20% for delivery & installation.

Challenger Trim Trails

Item	Brochure Page	Specification	Cost (exc vat)
<p>Potomac Trail</p> 	15-18	<p>Jelly board Rope bridge Zig Zag beam Rope walk Stepping logs Stilts Swinging log</p>	<p>Equipment Supplied and Installed £ 4,363</p> <p>Complete with Playsafe on Grass £ 7,627</p> <p>Complete with Playsafe on Tarmac £ 8,299</p>
<p>Item</p>	<p>Brochure Page</p>	<p>Specification</p>	<p>Cost (exc vat)</p>
<p>Chattahoochee Trail</p> 	15-18	<p>Chin-up bars Rope bridge Moving beam Balance beam Tyre crossing Rope walk Stilts Rock traverse</p>	<p>Equipment Supplied and Installed £ 5,341</p> <p>Complete with Playsafe on Grass £ 9,217</p> <p>Complete with Playsafe on Tarmac £ 9,933</p>

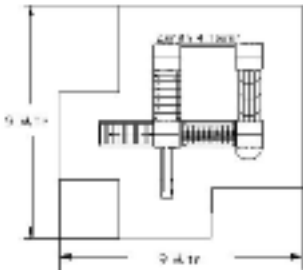

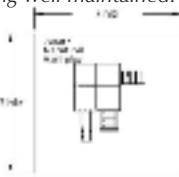

Delivery & installation included UK mainland on orders over £1,000 exc vat.
Orders less than £1,000 exc vat, add 20% for delivery & installation.

Zenith Tower Systems

Product Code	Item	Brochure Page	Specification	Cost (exc vat)
Z104	<p style="text-align: center;">Zenith Four</p>  <p>Slide, Clatterbridge, Vertical climbing panel, Shop unit, Net crossing, Ramp with rope pull, Firefighters pole, Seating under tower, Crawling tube, 4 towers</p>	21-22	<p>Equipment height : 3m Free height of fall : 1.2m or 1m Operating area : 65m² <i>Safer surfacing required.</i> <i>Grass or top soil can be used providing well maintained.</i></p> 	£ 11,516
ZNP100	<p style="text-align: center;">Zenith Nautical</p>  <p>Slide, Scramble net, 2 platforms, Captain's lookout, Moving ship's wheel, Arched climber</p>	21-22	<p>Equipment height : 2.4m Free height of fall : 1m Operating area : 49m² <i>Safer surfacing required.</i> <i>Grass or top soil can be used providing well maintained.</i></p> 	<p>£ 6,339 (unit only)</p> <p>£ 8,456 (including surfacing and inlaid designs)</p>
Z106	<p style="text-align: center;">Zenith Rustic</p> 	21-22	<p>All Zenith tower roofs can be made of half rounded timbers to give a more rustic country look. Ideal for woodland or environmentally sensitive settings.</p>	

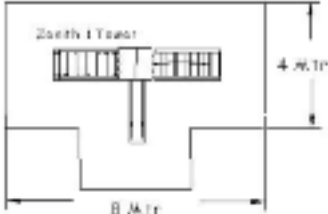
Safer surfacing is recommended for ALL Zenith tower systems. The operating height can be reduced to 1m to enable topsoil or turf to be used as safer surfacing. Seating is not available under towers where the height has been reduced.

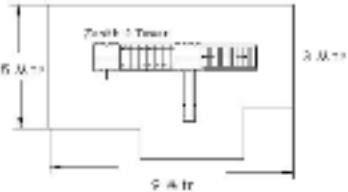
Zenith Tower Systems

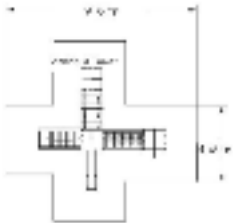
Product Code	Item	Brochure Page	Specification	Cost (exc vat)
Z101	<p style="text-align: center;">Zenith One</p>  <p>Slide Clatterbridge Log climber Ramp with rope pull 1 tower</p>	21-22	<p>Equipment height : 3m Free height of fall : 1m Operating area : 40m² <i>Safer surfacing required.</i> <i>Grass or top soil can be used providing well maintained.</i></p> 	£ 3,836
Z102	<p style="text-align: center;">Zenith Two</p>  <p>Firefighters pole Ramp with rope pull Clatterbridge Slide Vertical climbing panel 2 towers</p>	21-22	<p>Equipment height : 3m Free height of fall : 1m Operating area : 45.5m² <i>Safer surfacing required.</i> <i>Grass or top soil can be used providing well maintained.</i></p> 	£ 5,182
Z103	<p style="text-align: center;">Zenith Three</p>  <p>Firefighters pole Vertical climbing panel seating under tower Ramp with rope pull Clatterbridge Net tunnel Slide, Shop unit, 3 towers</p>	21-22	<p>Equipment height : 3m Free height of fall : 1m Operating area : 58m² <i>Safer surfacing required.</i> <i>Grass or top soil can be used providing well maintained.</i></p> 	£ 8,211

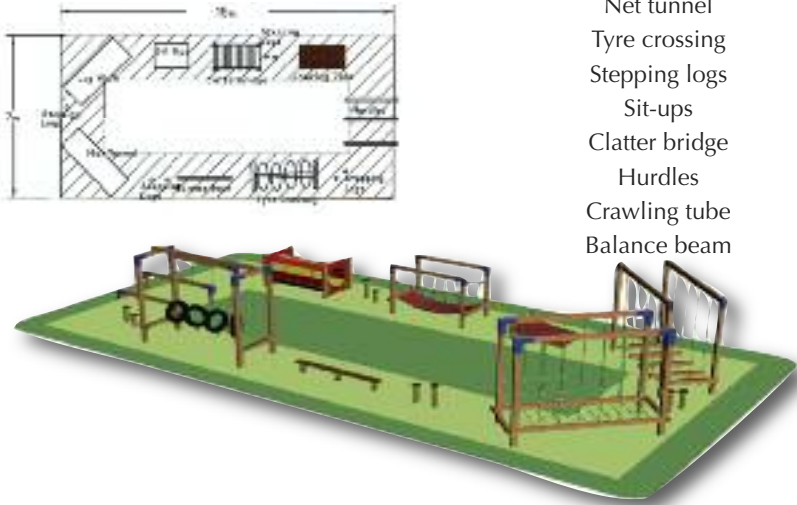
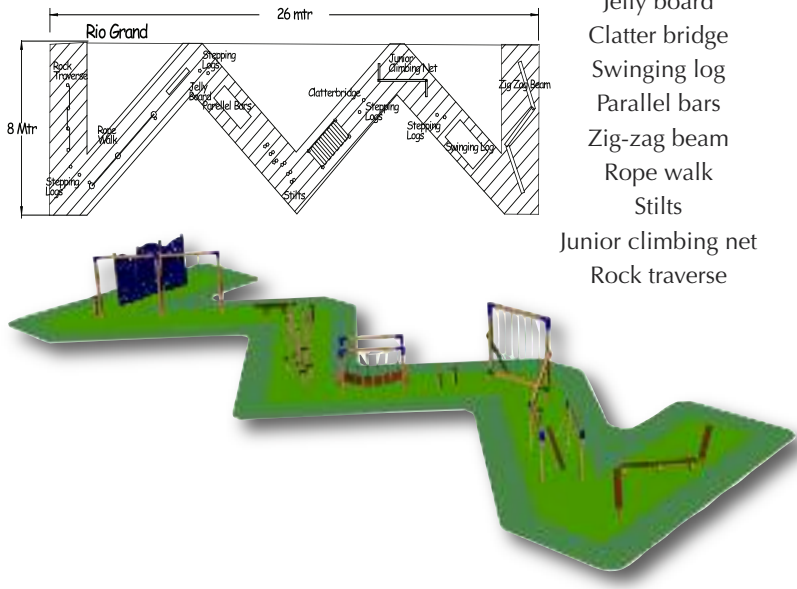

Delivery & installation included UK mainland on orders over £1,000 exc vat.
Orders less than £1,000 exc vat, add 20% for delivery & installation.

Challenger Trim Trails

Item	Brochure Page	Specification	Cost (exc vat)
<p>Mississippi Trail</p> 	15-18	<p>Log walk Net tunnel Tyre crossing Stepping logs Sit-ups Clatter bridge Hurdles Crawling tube Balance beam</p>	<p>Equipment Supplied and Installed £ 6,582</p> <p>Complete with Playsafe on Grass £ 10,254</p> <p>Complete with Playsafe on Tarmac £ 10,887</p>
<p>Rio Grande Trail</p> 	15-18	<p>Stepping logs Jelly board Clatter bridge Swinging log Parallel bars Zig-zag beam Rope walk Stilts Junior climbing net Rock traverse</p>	<p>Equipment Supplied and Installed £ 7,217</p> <p>Complete with Playsafe on Grass £ 12,419</p> <p>Complete with Playsafe on Tarmac £ 15,581</p>

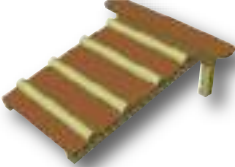
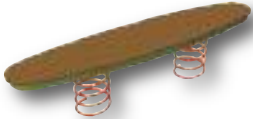

Delivery & installation included UK mainland on orders over £1,000 exc vat.
 Orders less than £1,000 exc vat, add 20% for delivery & installation.

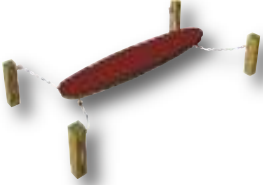
The Challenger Range

Product Code	Item	Brochure Page	Specification	Cost (exc vat)
1	Chin-up Bars 	19-20	Height : 80cm & 100cm Width : 1.9m Free height of fall: 1m Operating area : 20m ² <i>Safer surfacing required.</i>	£ 282
2	Ramp Jump 	19-20	Height : 50cm Width : 1.2m Free height of fall: 50cm Operating area : 18m ² <i>Safer surfacing not required.</i> <i>If installed on tarmac or concrete - surface with attenuating qualities recommended.</i>	£ 267
3	Jelly Board 	19-20	Width : 350mm Length : 1.5m Free height of fall: 35cm Operating area : 12.2m ² <i>Safer surfacing not required.</i> <i>If installed on tarmac or concrete - surface with attenuating qualities recommended.</i>	£ 644
4	Rope Bridge 	19-20	Height : 1.5m Length : 3m Width : 1.2m Free height of fall: 60cm Operating area : 14.9m ² <i>Safer surfacing not required.</i> <i>If installed on tarmac or concrete - surface with attenuating qualities recommended.</i>	£ 663
5	Moving Beam 	19-20	Height : 40cm Length : 2.1m Width : 1.2m Free height of fall: 60cm Operating area : 22.8m ² <i>Safer surfacing not required.</i> <i>If installed on tarmac or concrete - surface with attenuating qualities recommended.</i>	£ 691



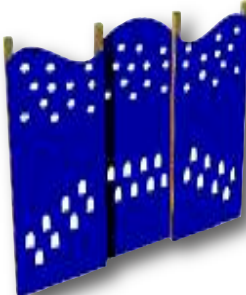

Delivery & installation included UK mainland on orders over £1,000 exc vat.
 Orders less than £1,000 exc vat, add 20% for delivery & installation.

The Challenger Range

Product Code	Item	Brochure Page	Specification	Cost (exc vat)
24	Leapfrog Posts (4 in a set) 	19-20	Height : 50cm to 90cm Fall height : 50cm to 90cm Operating area : 8m ² <i>Safer surfacing not required.</i> <i>If installed on tarmac or concrete - surface with attenuating qualities recommended.</i>	£ 291
25	Crawling Tube 	19-20	Height : 1.2m Length : 2.1m Width : 1m Free height of fall: 20cm Operating area : 9m ² <i>Safer surfacing not required.</i> <i>If installed on tarmac or concrete - surface with attenuating qualities recommended.</i>	£ 1,254
26	Tread Mill 	19-20	Height : 1.2m Length : 1.2m Width : 1m Free height of fall: 40cm Operating area : 9.6m ² <i>Safer surfacing not required.</i> <i>If installed on tarmac or concrete - surface with attenuating qualities recommended.</i>	£ 588
27	Climbing Wall 	19-20	Height : 2m Length : 3.2m Width : 20cm Free height of fall: 60cm Operating area : 6.5m ² <i>Safer surfacing not required.</i> <i>If installed on tarmac or concrete - surface with attenuating qualities recommended.</i>	£ 1,229

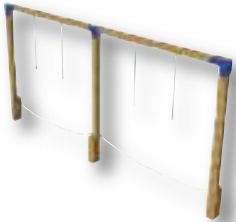

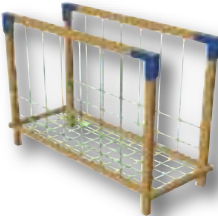

Delivery & installation included UK mainland on orders over £1,000 exc vat.
 Orders less than £1,000 exc vat, add 20% for delivery & installation.

The Challenger Range

Product Code	Item	Brochure Page	Specification	Cost (exc vat)
19	Rope Walk 	19-20	Height : 2.3m Length : 5m Width : 22m Free height of fall : 30cm Operating area : 18m ² <i>Safer surfacing not required.</i> <i>If installed on tarmac or concrete - surface with attenuating qualities recommended.</i>	£ 899
20	Overhead Ladder 	19-20	Height : 2.3m Length : 3m Width : 1.2m Free height of fall : 2m Operating area : 35m ² <i>Safer surfacing required.</i>	£ 1,033
21	Stilts (set of 6) 	19-20	Height : 1.4m Free height of fall : 45cm Operating area : 2m ² <i>Safer surfacing not required.</i> <i>If installed on tarmac or concrete - surface with attenuating qualities recommended.</i>	£ 521
22	Junior Climbing Net 	19-20	Height : 2.3m Width : 2.6m Free height of fall : 1m Operating area : 13m ² <i>Safer surfacing not required.</i> <i>If installed on tarmac or concrete - surface with attenuating qualities recommended.</i>	£ 997
23	Net Tunnel 	19-20	Height : 2.3m Length : 3.2m Width : 1.2m Free height of fall : 30cm Operating area : 12m ² <i>Safer surfacing not required.</i> <i>If installed on tarmac or concrete - surface with attenuating qualities recommended.</i>	£ 1,247



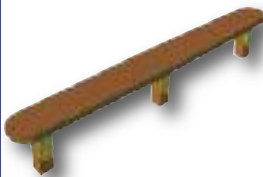

Delivery & installation included UK mainland on orders over £1,000 exc vat.
 Orders less than £1,000 exc vat, add 20% for delivery & installation.

The Challenger Range

Product Code	Item	Brochure Page	Specification	Cost (exc vat)
6	<p style="text-align: center;">Clatterbridge</p> 	19-20	<p>Height : 1.5m Length : 2.3m Width : 1.2m Free height of fall : 60cm Operating area : 12.5m² <i>Safer surfacing not required.</i> If installed on tarmac or concrete - surface with attenuating qualities recommended.</p>	£ 1,030
7	<p style="text-align: center;">Scramble Net</p> 	19-20	<p>Height : 2m Length : 1m Width : 2.4m Free height of fall : 2m Operating area : 27m² <i>Safer surfacing required.</i></p>	£ 1,115
8	<p style="text-align: center;">Balance Beam</p> 	19-20	<p>Height : 500mm Length : 3m Width : 15cm Free height of fall : 50cm Operating area : 9.8m² <i>Safer surfacing not required.</i> If installed on tarmac or concrete - surface with attenuating qualities recommended.</p>	£ 229
9	<p style="text-align: center;">Swinging Grips</p> 	19-20	<p>Height : 2.3m Length : 3m Width : 1.2m Free height of fall : 1.5m Operating area : 25.9m² <i>Safer surfacing required.</i></p>	£ 799

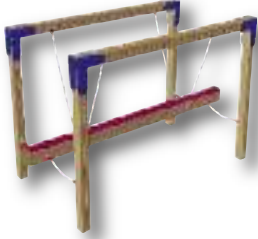



Delivery & installation included UK mainland on orders over £1,000 exc vat.
 Orders less than £1,000 exc vat, add 20% for delivery & installation.

The Challenger Range

Product Code	Item	Brochure Page	Specification	Cost (exc vat)
10	<p style="text-align: center;">Swinging Log</p> 	19-20	Height : 1.3m Log Height : 45cm Length : 2.1m Width : 1.2m Free height of fall: 50cm Operating area : 12.5m ² <i>Safer surfacing not required.</i> <i>If installed on tarmac or concrete - surface with attenuating qualities recommended.</i>	£ 635
11	<p style="text-align: center;">Parallel Bars</p> 	19-20	Height : 1.2m Length : 2m Width : 80cm Free height of fall: 1m Operating area : 14m ² <i>Safer surfacing required.</i>	£ 261
12	<p style="text-align: center;">Zig-Zag Beam</p> 	19-20	Height : 50cm Length : 6.9m Width : 2.2m Free height of fall: 50cm Operating area : 37.2m ² <i>Safer surfacing not required.</i> <i>If installed on tarmac or concrete - surface with attenuating qualities recommended.</i>	£ 659
13	<p style="text-align: center;">Sit-Ups</p> 	19-20	Height : 15cm Length : 1.5m Width : 1.2m Free height of fall: 50cm Operating area : <i>Safer surfacing not required.</i> <i>If installed on tarmac or concrete - surface with attenuating qualities recommended.</i>	£ 262

Delivery & installation included UK mainland on orders over £1,000 exc vat.
 Orders less than £1,000 exc vat, add 20% for delivery & installation.

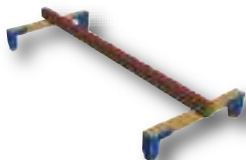
The Challenger Range

Product Code	Item	Brochure Page	Specification	Cost (exc vat)
14	Log Walk 	19-20	Height : 2.3m Length : 3.2m Width : 1.2m Free height of fall : 60cm Operating area : 21m ² <i>Safer surfacing not required.</i> <i>If installed on tarmac or concrete - surface with attenuating qualities recommended.</i>	£ 923
15	Hurdles (set of 3) 	19-20	Height (set of 3) : up to 90cm Width : 2.4m Free height of fall : 90cm Operating area : 38.7m ² <i>Safer surfacing not required.</i> <i>If installed on tarmac or concrete - surface with attenuating qualities recommended.</i>	£ 468
16	Tyre Crossing 	19-20	Height : 2.3m Length : 3m Width : 1.2m Free height of fall : 50cm Operating area : 16m ² <i>Safer surfacing not required.</i> <i>If installed on tarmac or concrete - surface with attenuating qualities recommended.</i>	£ 827
17	Log Bridge 	19-20	Height : 50cm Length : 3m Width : 1.2m Free height of fall : 50cm Operating area : 11.6m ² <i>Safer surfacing not required.</i> <i>If installed on tarmac or concrete - surface with attenuating qualities recommended.</i>	£ 461
18	Stepping Stones 	19-20	8 in a set Heights between : 20cm & 50cm Used as a link between other items. <i>Safer surfacing not required.</i> <i>If installed on tarmac or concrete - surface with attenuating qualities recommended.</i>	£ 342

Delivery & installation included UK mainland on orders over £1,000 exc vat.
 Orders less than £1,000 exc vat, add 20% for delivery & installation.