

# G.B. Sport & Leisure

## ADDITIONAL EXTRAS

### Playground Spares, Repairs & Refurbishment Accessories

For All Your Playground Needs

Order today and have it tomorrow!



Spare Parts



Safety Surfacing



Tools & Fixings



Fencing & Gates



Personal Protective Equipment



Signs & Barriers



Tel: 0845 803 07 87

Fax: 01934 612178

E-mail: [sales@gbsportandleisure.co.uk](mailto:sales@gbsportandleisure.co.uk)

Web: [www.gbsportandleisure.co.uk](http://www.gbsportandleisure.co.uk)

Date of issue: April 2008

# Introduction

Welcome to G.B. Sport & Leisure's Spares Plus brochure, an invaluable catalogue of spares, tools and handy tips for the safe maintenance of all your play area equipment and surfacing.

Inside you'll find a huge range of products to assist you with the maintenance and general upkeep of your play areas to keep them in safe working order.

There is useful information and solutions to those unfortunate problems that arise on site, along with general instructions and special tips on how to use our products.

As always you'll find Mr Stockey popping up to provide helpful hints! You may also notice a few new characters along the way too!

We hope that you find this brochure helpful and knowledgeable.

From all the G.B. Sport & Leisure Team Happy Reading!

## INDEX

|  |  |
|--|--|
| 2 Troubleshooting                                  | 15-16 Multiplay Accessories & HDPE           |
| 3-4 Swing Seats & Spares                           | 17-18 Play Panels & Treadsafe                |
| 5-6 Swing Solutions                                | 19-24 New Play Equipment                     |
| 7-8 Aerial Runway & Seesaw Spares                  | 25-26 Sail Shades                            |
| 9-10 Play Equipment Maintenance & Measurements     | 27-30 Safety Surfacing Accessories           |
| 11-12 Renovation                                   | 31-32 Wet Pour Graphics & Rubber Scrub       |
| 13-14 Graffiti Remover, Gate Springs & Accessories | 33-34 Personal & Site Safety and Inspections |

There are certain products and tools that we class as invaluable and therefore are highly recommended.

Watch out for the STAR BUY sign for these "MUST HAVE" products.



Orders, invoicing & payments can all be processed electronically

## MEET THE TEAM



Gary Barber  
South West  
Sales Manager  
[gary@gbsportandleisure.co.uk](mailto:gary@gbsportandleisure.co.uk)



Kirsty Masland  
Midlands & East Anglia  
Sales Manager  
[kirsty@gbsportandleisure.co.uk](mailto:kirsty@gbsportandleisure.co.uk)



Alexis Barber  
South East & London  
Sales Manager  
[alexis@gbsportandleisure.co.uk](mailto:alexis@gbsportandleisure.co.uk)



Colin Lewis  
South Wales & Ireland  
Sales Manager  
[colin@gbsportandleisure.co.uk](mailto:colin@gbsportandleisure.co.uk)



Terry Vagg  
Scotland & The North  
Sales Manager  
[terry@gbsportandleisure.co.uk](mailto:terry@gbsportandleisure.co.uk)



Joanne Andrews  
Accounts Manager  
[jo@gbsportandleisure.co.uk](mailto:jo@gbsportandleisure.co.uk)



Mr Stockey  
Stock Control



General Enquiries  
[sales@gbsportandleisure.co.uk](mailto:sales@gbsportandleisure.co.uk)

# Troubleshooting

## Does this sound familiar?

You are on site, it's late Friday afternoon, you're cold and you're tired, all you want is a nice cup of tea. You have one last site to visit, there are numerous pieces of equipment that are in need of repair, it sounds a simple job. You arrive on site and start to inspect the equipment, but wait, there are no identification labels! They look really old and you have never seen a piece like it, how are you going to source spares for a piece of equipment that you have no idea who manufactured?



Confused & can't identify it



Thinking



Had an idea



Take photos



Email to [sales@gbsportandleisure.co.uk](mailto:sales@gbsportandleisure.co.uk)



Product identified  
Parts ordered and shipped



Job done!



Safe working play area

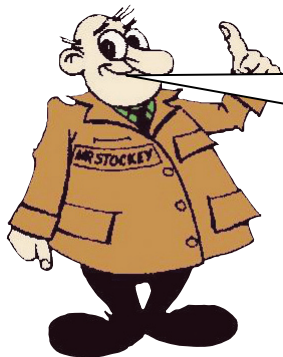

If you require some immediate on site guidance, why not enquire about our invaluable Groundsman's Handbook!



Including how to:

- Measure chains correctly
- Hang chains and fit Varilinks
- Fit/remove seloc pins
- Fit/remove/check bushes
- Fit HDPE Panels
- Adjust gate springs
- Taking accurate site levels
- Fit Rocking Horse Seats
- Tension Aerial Runway Cables
- Using Heat Shrink Tape
- Safety surface repairs

You are guaranteed to keep this handy Groundsman's Handbook with you for every trip to site.

It has taken the writers of this hand book **20** years to gain all this knowledge, and all their secrets, hints and tips are now available for you to take advantage of!

Packed full of handy hints, tips and advice for all your playground maintenance needs.

Email: [sales@gbsportandleisure.co.uk](mailto:sales@gbsportandleisure.co.uk)

# Swing Seats & Spares

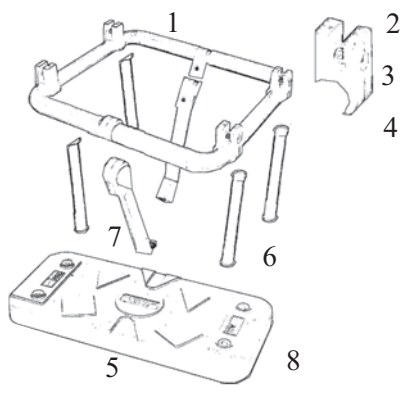

## PREMIER CRADLE SEAT

1. Top Ring
2. Swing Clip
3. Nut
4. Bush
5. Bolt
6. Pillar Assembly
7. Centre Strut
8. Seat Base

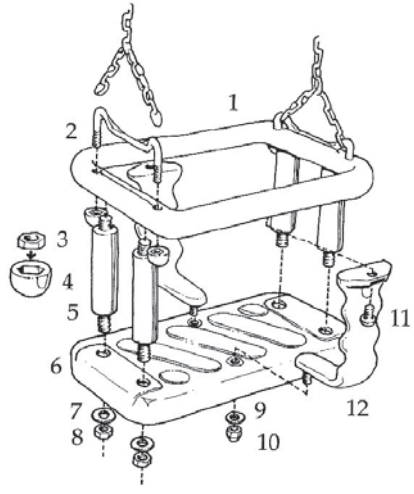

## SUTCLIFFE NEW STYLE CRADLE SEAT

1. Top ring
2. U Bolt
3. Binx Nut
4. U Bolt Plastic Cap
5. Pillar Assembly
6. Seat Base
7. Plain Washer
8. Nyloc Nut
9. Plain Washer
10. Nyloc Domed Nut
11. Socket Button Head Screw
12. Centre Crutch Support

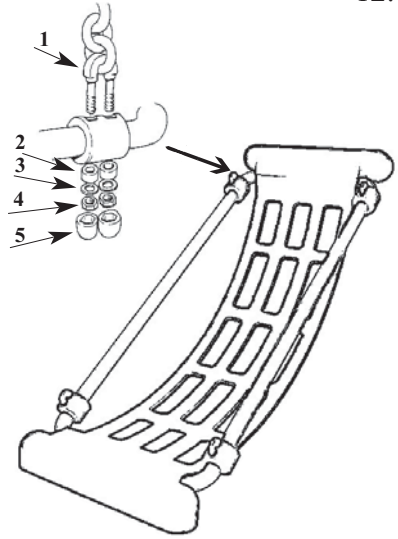

## INCLUSIVE SEAT

1. U Bolts
2. Nylon Bushes
3. Washers
4. Binx Nuts
5. Dome Nuts
6. Full Fixing Kit

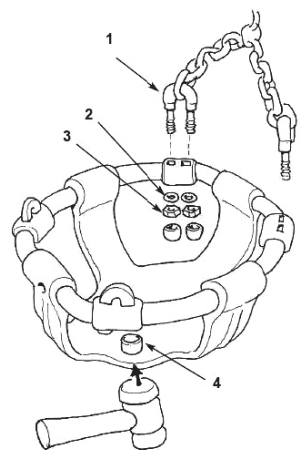

## POD SEAT

1. U Bolt 6mm & 8mm
2. Washer
3. Locknut
4. Nut Cover

# Swing Seats & Spares

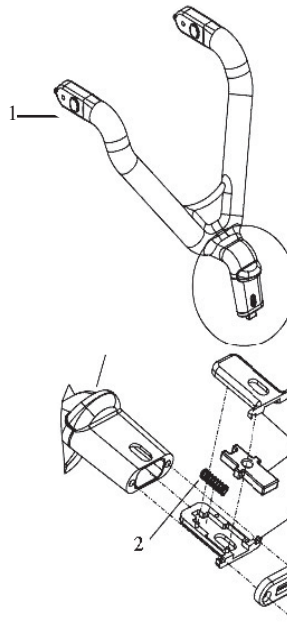

## ACCESSIBLE SEAT

1. Seat Harness
2. Compression Spring
3. Flat Head Bolts
4. Latch Cap
5. Housing
6. Latch Push Pin

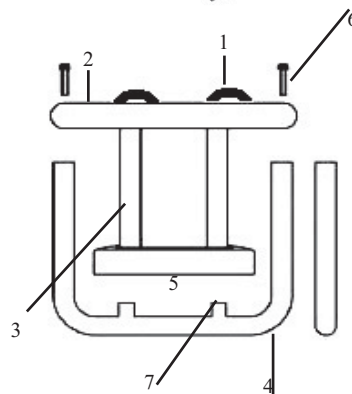

## J HOOK CRADLE SEAT

Available assembled or flat packed for ease of storage

1. J Hook Bolts
2. Top Rings
3. Side Supports
4. Front Supports
5. Seat Base
6. Security Bolts
7. Nuts

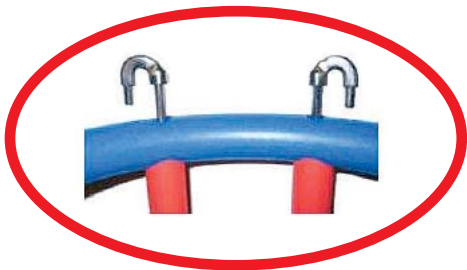

Check out this **NEW** cradle!  
 Its one of my favourites  
 and when you see the  
 price you'll see why!



## Other Swing Seats Available

G.B. Sport & Leisure Flat Seat



BIRDS NEST SEAT



Sutcliffe Large Flat Seat



NEW EURO FLAT SEAT

TÜV Tested  
 Ergonomically designed for  
 maximum comfort. The  
 rounded shape also prevents  
 moisture from resting on the  
 surface.



# Swing Solutions

Do you have an ongoing problem with dogs damaging swing seats? Now there is a solution.....

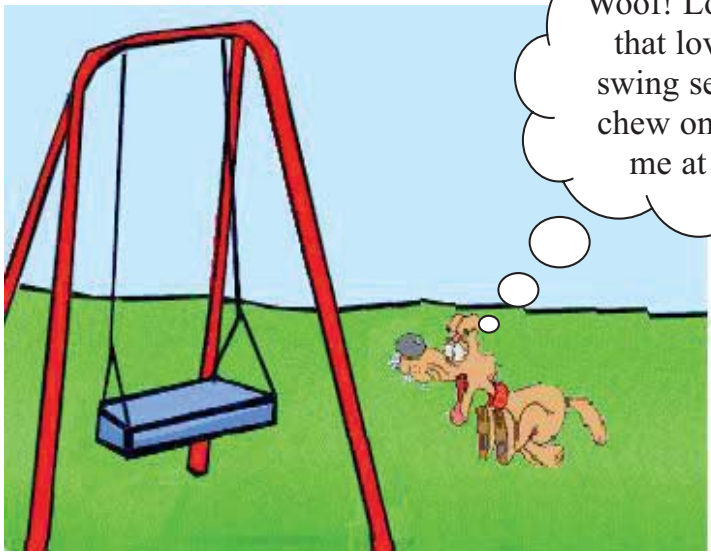

## SOLUTION A: WRAP AROUND SEATS



These wrap around seats are no good! I can't grip onto them like the flat ones! How will I ever chew them up?



## SOLUTION B: DOG DETERRENT SEATS

The Sutcliffe Large Flat Seats and New Style Cradle Seats are available with a dog deterrent coating.

The natural oil called "Citronella oil" can be used in the moulding process of some of the rubber seats in our range. The oil is made from the leaves of the "Cynbopogan Winterianus Jowitt" plant. It has many uses but is mainly used in most insect repellent sprays. The oil comes from a completely natural source and process. Although it deters Dogs, it is completely harmless to Humans and Animals. The oil gives off a sweet, fresh, citrus scent which most dogs (with their strong sense of smell) do not like.

We offer this treatment to deter animals such as Dogs from chewing and destroying swing seats.

However, there will always be some individual Dogs that it may not deter but in the main, customers who have purchased these swing seats in the past have been very happy with the results!



New Style Cradle Seat



Large Flat Seat

# Swing Solutions



**Scale Swing Buffer**  
50mm diameter rubber cone buffer with M10 thread.



**Group Swing Swivel & Horizontal Swivel**  
Stainless steel swivel for use with timber and steel swings  
Fixing Plate 70mm wide



**Shell Bearing**

**Main Bearing Block**

**Oilite Bush**

**Shackle**

**6mm Grease Nipple**

**Anti-Wrap Bearings**

Suitable for standard swing chains. Grease nipple for easy lubrication. When ordering Anti-Wrap Bearings please ensure to state the diameter of the crossbar!

**Varilinks**

For chains without large adjusting links. Makes height adjustment very easy!



# Aerial Runway Spares



### NEW Pendulum Seat & Chain Set:

Specification:  
 8mm chain  
 Squeeze protection between seat and protection tube  
 Stable mechanical conjunction between seat and chain  
 Replaceable chain  
 Length 2m  
 4mm Steel insert  
 Anti-skid surface with soft side  
 BS/EN 1176-2 requirements



### Pendulum Seat Spares:

1. U Bolts
2. Nyloc Nuts
3. Washers



### NEW 3m Brake Spring

For use at the stop end of the aerial runway giving a greater stopping distance



### Sutcliffe Rubber Sleeve

8mm rubber sleeve

### Complete Aerial Runway Kits

Please see page 7 of our main spares brochure for pictures of our complete aerial runway kit components which include:

**10mm Cable**

**Cable Holding Device**

**U Bolt**

**6 Cable Grips**

**Brake Spring**

**Pendulum Seat**

**Cable Tensioning Device**

**2m Chain**

**Jockey**

**Sleeve**

# Seesaw Spares

### NEW Seesaw Softener:

The function of the Seesaw Softener is quite simple, as it makes use of the known impact reduction technique already used for years in safety surfacing. In short, the top being made of SBR rubber achieves the reduction of the impact.

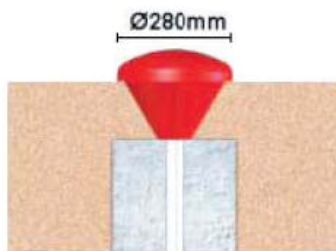

Can also be used in wet pour surfacing as low stepping stones!

### Seesaw Handles

Available with round or square base.  
 25mm Ø stainless tube



**Square Handles**

**Round Handles**

140mm, 160mm, 180mm diameter

# Miscellaneous



**M10 Flower Do-Nut Caps**  
 Available in red, yellow, blue, green, purple, white and black.  
 Ours have more depth for the fixings, so you are less likely to be caught in-between fixing sizes.  
 Made in the UK from high quality UV stabilised plastic and a more attractive looking design means that there really is only one choice.



Our Flower Do-Nut Cap (left) compared to another (right).



**Dome Nuts**  
 Available in sizes: M8, M10, M12



**Sheer Nuts**  
 M8, M10 & M12



**Fencing Bolts**  
 M10 x 25  
 M10 x 30  
 Other sizes available



**Bolt Cover**  
 For safety and resistance to vandalism



**Pentagon Keys**  
 Available singularly or in a set of seven.



**Torx Resist Bolts & Allen Keys**  
 A huge range of bolt sizes available.  
 Available in M3, M4, M5, M6, M8, M10, M12



**T45 Ratchet Attachment**  
 Undo & tighten your torx resist bolts with ease. Just attach to your ratchet and away you go.



Thread length: 50mm

Thread length: 50mm

Thread length: 75mm

**Long Shank Eye Bolts**

Three sizes available:  
 M12 x 145, M12 x 120, M10 x 95  
 For timber and steel equipment

Need different sizes?  
 Just ask and we'll endeavour to meet your requests!



**Eye Bolts**

M12 Plated and M10 Collared



**Eye Nuts**

Available in a range of sizes

# Play Equipment Maintenance



**Warning / Anti-Slip / Barrier Tape**  
Available in a range of colours



**Gaffer Tape**  
For use with our net repair kits - see page 11



**30" Litter Pickers**  
Trigger action handle operates specially shaped plastic jaw for easy pick-up of all types of litter. Lightweight aluminium shaft.



**Punch**  
1-16" Square Head 4" Long  
Other sizes available



**Hammer**  
One piece all steel claw hammer 16oz



**Lump Hammer**  
Fibreglass handle 4oz



**Rubber Mallet**  
Various available



**Rivets** various sizes  
**Rivet Gun** Professional rivet tool, 4 nose pieces



**Adjustable Spanner**  
Chrome adjustable wrench 6". Jaw capacity 19mm



**Locking Pliers**  
7" straight jaw



**Clamp**  
4" clamp, opening 4", Depth 2 3/8"

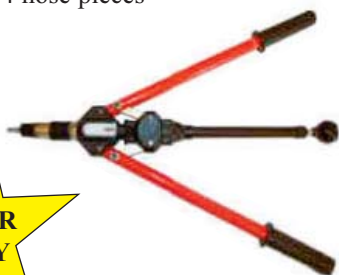

**Insert Tool**  
For easy setting of rivet nuts up to M10



**Rivet Nuts**



**Bolt Croppers**  
High tensile centre cut bolt cutters 24". Cutting capacity 10mm mild steel, 8mm high tensile



**Engineers File**  
10" hand second cut



Tighten fixings to the manufacturer's specification

**Torque Wrench**  
1/2" square drive 30-150mm, range 20-110lb, length 420mm



**Wrench**  
Wide jaw wrench. Drop forged with 5 position adjustments. Length 9" Max opening 3"



**Extension Lead**  
Cable reel 25m 16amp 110v



**Tool Belt**  
Tools not included.



# Play Equipment Maintenance



**Grease** various greases available  
**Grease Gun** heavy duty side lever



**Angle Grinder**  
 115mm 110v  
 Discs various sizes available  
 For certified users only



**Pulley Winch & Straps**



**DeWalt Cordless Impact Driver** 1/2" Drive 12v  
 Fit swing seats, chains and shackles in a fraction of the time

**15 piece Impact Driver Set**  
 1/2" square driver, 12 impact bits, 6 x 36 flat, 8 x 36 flat x 10 x 36 flat, 12 x 36 flat, PH1, PH2, PH3, PH4, 4mm hex, 5mm hex, 6mm hex, 8mm hex, 1 1/2" drive h/d reversible impact driver, 1 1/2" drive impact coupler adaptor, 1 hex x 3/8" male adaptor



**Cordless Drill**  
 Various models available



**Drill Accessories**

## Measurements



**Measuring Wheel**  
 Digital measuring wheel. Measures up to 9999.99m. 5 year battery life and 3 year guarantee



**Tape Measures**  
 5m and 30m tape measures available



**Vernier Callipers 150mm**  
 Stainless steel with imperial and metric reading. Measures swing bushes and crossbars



**Line Level**  
 To measure site levels quickly and easily.

**Laser Levels**  
 Save time on set-up with this Self-Levelling Level. Pendulum-mounted horizontal and vertical beams work independently or together for quick, precise alignment. Laser Line & Cross

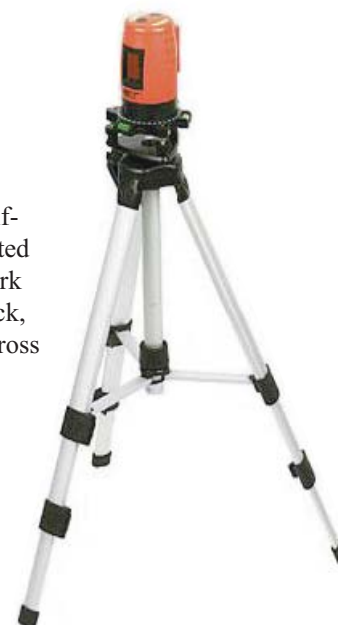

# Renovation

Like us all, playground equipment ages with time and can become worn and unsafe. The products in this section can help rejuvenate your equipment, prolong their life span and make them safe for play again, not to mention how great they look after a make-over!

Damaged nets are easily fixed with our new **Net Repair Kit**.

Containing:

- 2no Tube Connectors
- 1no 1m Length Rope

See page 9 for gaffer tape



FROM THIS

TO THIS!



FROM THIS

**Did you know we do makeovers?**  
With a couple of sheets of HDPE and few cans of paint, your tired equipment can be transformed into an object of beauty again!



TO THIS!

If you didn't know better, you'd think this train was brand new!  
So next time you think your equipment has run its course, contact us to see if we can bring it back to life for you!

# Renovation



### Replacement Kick Boards & Seats for various pieces of equipment

Just let us know what needs replacing and we'll supply a suitable product to put the equipment back in safe action.



### Steel Deck Plates

Replace damaged platforms with hard wearing steel decks. Ridged on the wearing face to provide grip underfoot.

### Steel Roofs

Say goodbye to damaged plastic & fibre glass roofs and hello to a new steel fire resistant one!



**BEFORE**



**AFTER**

### Stainless Steel Slide Chutes

No need to dispose of complete frames when the slide is damaged. Just let us know the platform height and we'll provide a new stainless steel slide chute to suit!



TUV Tested  
500mm wide to suit mounting heights:  
0750-1000mm  
1250-1500mm  
1750-2000mm  
2250-2500mm

### Stainless Steel Sliding Poles

Stainless steel 38 x 2mm tube with mounting plates. Suitable for 2255mm deck height



Mounting as a single sliding pole unit  
Or  
2 poles SIDE-BY-SIDE

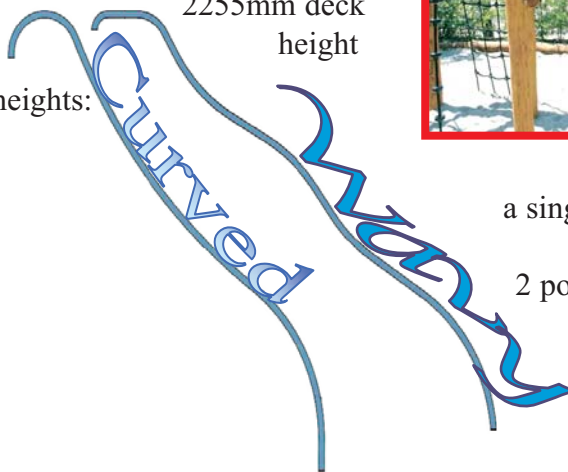

**Email: [sales@gb sportandleisure.co.uk](mailto:sales@gb sportandleisure.co.uk)**

# Graffiti Remover

*Graffiti is a problem in all areas. It can be ugly, rude & sometimes offensive. But most of all, it's annoying!*  
*It's for these reasons that we have now widened our product range to assist you in the war against Graffiti!*

## Non-Porous Surface Anti-Graffiti Wipes



Anti-graffiti wipes are a unique one-step graffiti removal system combining a highly absorbent, abrasive but non-scratching remover towel, pre-moistened with an effective removal solution. Designed for use on non-porous surfaces such as glass, steel, metal, ceramic tiles, marble & laminated surfaces. Anti-graffiti wipes will remove graffiti caused by spray paint, permanent marker pens, crayon and ball point pen.

- Easy to use for the effective removal of graffiti
- Suitable for use on non-porous surfaces (e.g. bus shelters, signs, lifts and street furniture).
- May be used on surfaces previously protected by the anti-graffiti coating
- Will remove spray paint, permanent marker pen and other graffiti
- 30 pre-moistened wipes per pack

## Porous Surface Anti-Graffiti Coating, Wash & Remover System



Anti-graffiti coating, wash & remover system is the ideal solution for removing graffiti from porous surfaces such as brick, cement and concrete. The system combines a UV resistant polyurethane coating which acts as a barrier between the substrate and graffiti, enabling easy graffiti removal with the wash & remover.



### STEP ONE

#### Coating

- \*Non-sacrificial, clear polyurethane coating. \*Excellent graffiti removal properties.
- \*Easy to apply \*Water based/low odour \*Fast Curing \*UV resistant/colour stable
- \*Theoretical coverage: 30m<sup>2</sup> per 2.5 litre pack

**Pack size: 2.5 litres**



### STEP TWO

#### Wash & Remover

- \*Quick & easy to use \*Convenient aerosol sprays
- \*Effectively eradicates the toughest graffiti

**Graffiti Wash Pack Size: 300ml**

**Graffiti Remover Pack Size: 400ml**

# Gate Springs & Accessories



## Prosafe Gates

### Hydraulic Closure Mechanism

Dual Action Hydraulic Mechanism which is fully shielded to prevent vandalism. The mechanism makes the Prosafe Gate virtually impossible to slam shut and prevents it from bouncing back when pushed hard.



### Adjustment Key

The specially designed Adjustment Key is required for adjusting closing speed and tension and is also available from stock.

## Self Closing Gate

All replacement self closing spring parts available as listed below

- Spring Adjuster
- Stainless Steel Bar
- Roll Pin
- Rivet
- Hinge Pins
- Split Pins



## Noreg Self Closing Gate Hinges

Fully enclosed gate hinge  
Easily adjustable closing speed settings.  
Please state when ordering if the gate is left or right handed and opens in or out.

## Easi Gate Closers

Made from long lasting stainless steel.  
An economic way to ensure pedestrian and field gates close automatically.

- Easy fitting on timber or steel gates
- Hydraulically controlled closing speed
- Sturdy stainless steel construction
- Ultra quiet operation
- No spring mechanism
- Complete kit with brackets



Email: [sales@gb sportandleisure.co.uk](mailto:sales@gb sportandleisure.co.uk)

# Multiplay Accessories

There are so many types of Multiplay Units around with so many different accessories and components. This page shows a small selection of accessories available. For full listings, please refer to our play equipment catalogue and spares brochure.



**Trapeze Rings**

Trapeze rings can add a great challenging play aspect to any unit. Available in a range of colours. Manufactured from vandal resistant, multi-filament polypropylene steel cored rope.



**Oxo Cubes**

A timeless classic! Polyethylene spinning cubes. 165mm Ø x 230mm length. Central opening Ø 14mm. Encourages children to play together and helps develop logical thinking. Can be added to existing play units or built into their own frame.

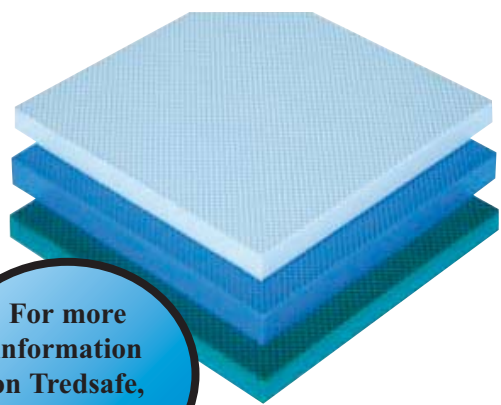

**Tredsafe & Buffalo Board**  
Non-slip surfaces are a must for any Multiplay Unit!



Buffalo Board is manufactured in a huge range of sizes and thickness to suit your requirements.

For more information on Tredsafe, see page 18.

**Grab Rails**



Safety is the most important aspect of any playground and these hand rails & pull up ropes are the perfect way to help the little ones safely through their adventure

**Coupling Links**

Used as an alternative to Quick Links. Coupling Links are a robust design supplied in two halves which join in the centre. This allows the link to have central movement and a swinging motion which helps reduce wear on the attached components. Coupling Links are ideal for securely fixing pull up ropes & chains.



**Pull Up Ropes**



**Stone Wall Climbing Panel**

Featuring high impact resistant HDPE Rock Holds

**Densetec HDPE Panels**



**Densetec Two Colour**

**Densetec Single Colour**

**Densetec HDPE** is a thermoplastic sheet with multiple coloured layers. The material is manufactured by co-extruding two contrasting colours, one on the inside and one on the outside. Also available in single colour. Either option will not need re-painting as the colour is embedded into the sheet. This also means the colour will not chip, flake or wear away.

- Easily engraved and routed
- Range of bright & contrasting colours as standard.
- UV stabilised.
- Will not rot, delaminate, splinter or crack.
- Moisture & chemical resistant.
- Recyclable & non-toxic.
- Highly impact resistant.

Standard sheet size: 1220mm x 2440mm

Thickness: 12.5mm & 19mm

Ideal for play panels, sports panels, interior & exterior signage, side panels & Springers.

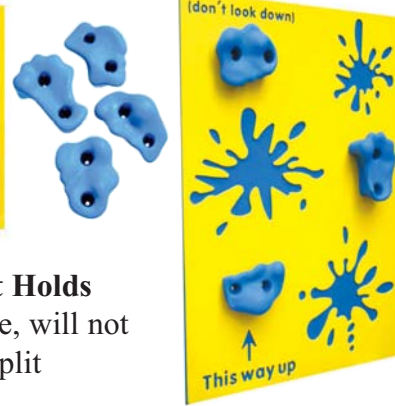

**Hand/Foot Holds**

Highly durable, will not rot or split

**Splash Climbing Wall**

**Cut out style climbing wall**

Very popular style of climbing wall with cut-outs for foot holds, this panel can be supplied plain or in many other decorative & alluring styles!

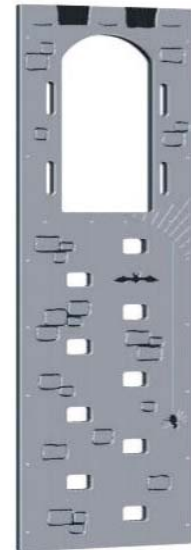

Plastic post caps to fit 100mm square logs. Round caps also available



**HDPE Slide Entry Panel**

Available in a range of colours and designs.

**HDPE Slide Chutes**, twin-walled polyethylene slides are stackable for easy storage and available in red, blue, green and yellow.

Sizes to deck heights:

600mm – 900mm – 1200mm – 1500mm

Our play panels are great for  
DDA Applications

# Play Panels

Transform your playground  
equipment with single or two colour  
co-extruded HDPE Play Panels!

## EDUCATIONAL PANELS



Alphabet Upper  
& Lower case

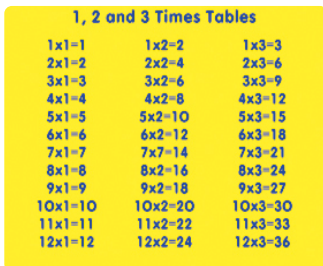

1, 2 & 3 Times Tables



Tubular Bells



Animal Search

## ACTIVITY PANELS



Wiggly Window



Chalk Board



Little Bo Peep

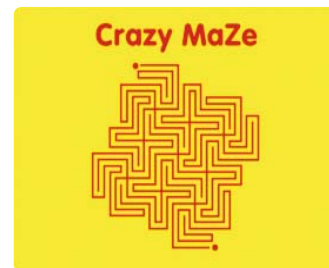

Crazy Maze

This is just a tiny selection of our play panels. To see the full range visit [www.gbsportandleisure.co.uk](http://www.gbsportandleisure.co.uk) or contact our sales office on 0845 803 07 87

## SPINNING/MOVING PANELS



Twinkle Twinkle  
Little Star



Show Me How To...

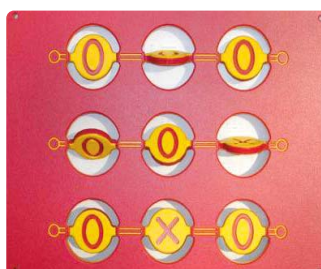

Noughts & Crosses

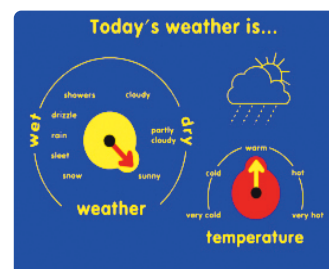

Today's Weather

## ILLUSION PANELS

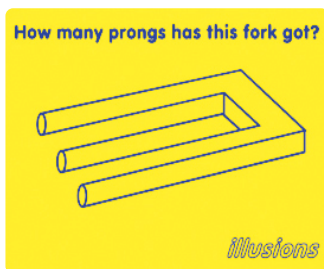

How many prongs?



Horse or Seal?

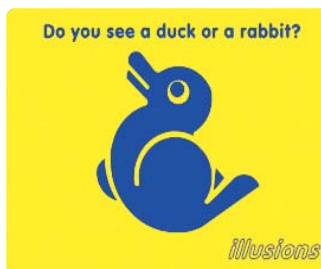

Duck or Rabbit?

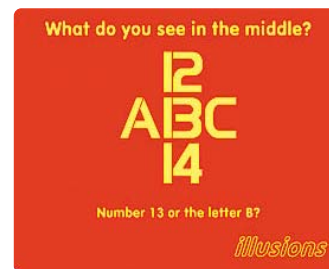

ABC or 12, 13, 14?

## ROLE PLAY



Shop Counter



Pirate

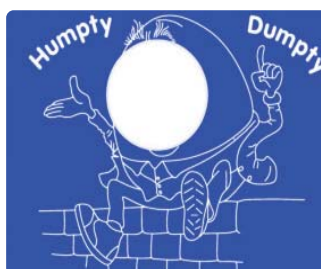

Humpty Dumpty



Car

Tel: 0845 803 07 87

Fax: 01 934 61 21 78

# TredSafe Boards

TredSafe is the latest HDPE sheet on the market.

Designed to be used as decking material in Marine & Playground industries, TredSafe incorporates the latest available technologies to produce a slip-resistant surface.

Firstly, TredSafe features an embossed surface with circular protrusions on the upper face of the sheet. It is these protrusions that create a non-slip surface for the sole of the shoe whilst allowing water to pass between for fast draining, thus making TredSafe a particularly effective walking surface in wet conditions.

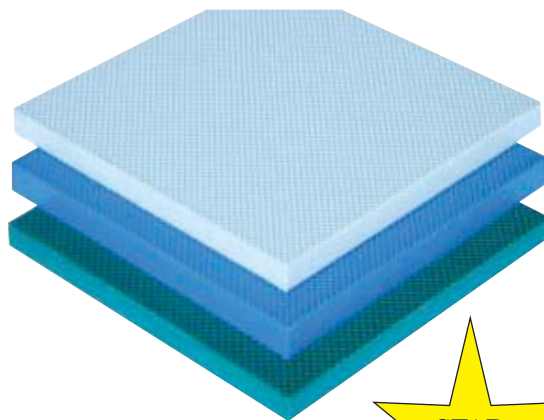

Secondly, TredSafe is manufactured using a high grip compound on the surface of the sheet, offering a slightly tacky, high coefficient of friction material on the walking surface. This compound, when combined with the top surface texture, makes TredSafe the ideal material for a slip resistant playground deck.

## TREDSAFE USED TO CREATE A NON-SLIP PLAY TOWER PLATFORM

### FEATURES:

- Protrusions grip shoe surface
- Slip resistant compound layer
- Water drains away beneath surface layer
- Stain & graffiti resistant
- Moisture resistant
- Available in a wide range of colours & designs

\*Please note- Protrusions are only on the walking surface of the board. The other side has a standard orange peel finish.



### APPLICATIONS:

- Playground decks & platforms
- Marine decking
- Walkways & ramps
- Anywhere an anti-skid surface is required

### STANDARD SHEETS:

**Width & Length:**  
1200mm x 2440mm  
**Thicknesses:**  
15mm & 19mm

### TredSafe Walking Surface



TredSafe can even be used to create eye catching signs & displays!



### STANDARD COLOURS

15mm - Black & Yellow    19mm - Blue

Other colours available on request but subject to minimum order quantity

**Email: [sales@gbssportandleisure.co.uk](mailto:sales@gbssportandleisure.co.uk)**

# New Equipment

Our designers are always coming up with new ideas and products. Below you will find a selection of the new products we have to offer.



After a long awaited debut, we are pleased to launch the fantastic **BABY MOUNTAIN GORILLA!** Complete with all the same great features as **The Mountain Gorilla** but on a smaller scale for the younger user.



### GrasseDeck

Unique, innovative decking inlaid with artificial grass



Rubber Step Posts



Stepping Stilt

Perfect for schools & nurseries!



**Picnic Tables**  
Available with Mushroom Tops, Design Inserts & in a wide range of colours.

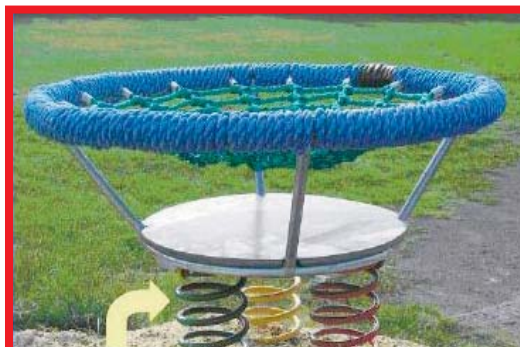

**Spring Birds Nest**  
Galvanised Steel Plate. Mounted on 3 Springs



**Overhead Spinner**  
1.8m high

# New Equipment



The newest item added to our equipment range is the Atmos. A futuristic looking unit designed for use by older children.

With climbing areas, sliding areas and a chill out zone, it really does have everything that older users are looking for.

## KIDDABOUT ROUNDABOUT



- Sits flush with ground for wheelchair access
- Sit On
- Stand On
- Hang On
- Inclusive Play
- Kitemarked to EN1176



## MONO HINGE SELF CLOSING GATES

The latest design in self closing gates.

Opening to 110 degrees to prevent recoil, the wheelchair accessible Mono Hinge Gate has no finger traps, crush points, shear actions or head traps and incorporates easily adjustable closing speeds and torsion settings.



Can be left or right handed and open inwards or outwards. Available in a range of heights, widths & colours



Adjustment Keys also available



**Email: [sales@gb sportandleisure.co.uk](mailto:sales@gb sportandleisure.co.uk)**

# New Equipment

## The Screamer!



50.25m<sup>2</sup> @ 3.0 FFH

The new and exciting ride from GB Sport & Leisure, the Screamer is more than just an exhilarating spinning ride! Through the oscillating rotation of the swing beams, both riders will experience and enjoy the big ride dual sensations of spinning with the rising and falling motion that the compact Screamer produces.

Requires two users to counterbalance the unit & produce spin.

Stainless steel trapeze bar & stand on post with rubber grip. Centre post & top beam available powder coated only or zinc sprayed & powder coated.

3m height

Suitable for ages 10+

8.0m diameter surfacing area

## Large Platform Tunnel Slide



49.5m<sup>2</sup> @ 2.4 FFH



2.4m 'D' shaped Polydeck Platform on single post

Steel Vertical Bar Safety Surround

Scramble Net

2.4m high Stainless Steel Tunnel Slide

Tunnel section helps build self confidence whilst Scramble Net helps develop strength & agility

9.0m x 8.0m area maximum is required

# New Equipment

## The Buddybout

2.0m Steel frame roundabout with speed restrictor

The curved adjacent seats allow either carers or parents to sit along side the child to provide extra supervision if necessary, or for children to sit along side their 'buddy' helping to form friendships and build social skills.

The more enclosed seating arrangement provides extra hand grip space.

Aluminium Checker Plate Deck.

Available with either powder coated steel or stainless steel seating section with 6 HDPE seats.

6.0m diameter required surface area.

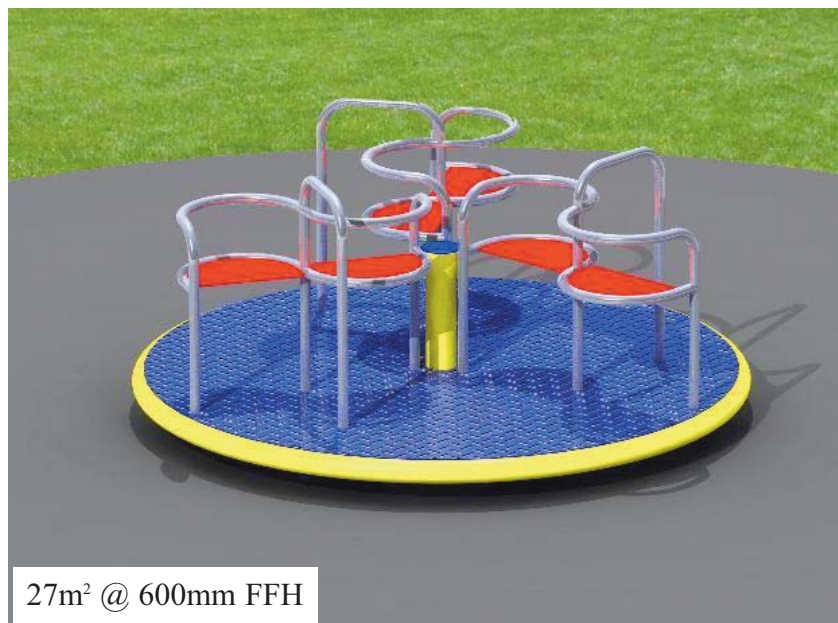

27m<sup>2</sup> @ 600mm FFH

## Bouncing Mushrooms, Discs & Step Head

An alternative to our already hugely popular Static & Spinning Mushrooms and Static Step Heads.

Manufactured in rubber with a steel core.

These incredibly fun and attractive units are a must for any recreational area.

The up & down bouncing action provides hours of fun for children of all ages.

This new bouncing range helps develop balance, strength and imagination whilst encouraging confidence and self-assurance.

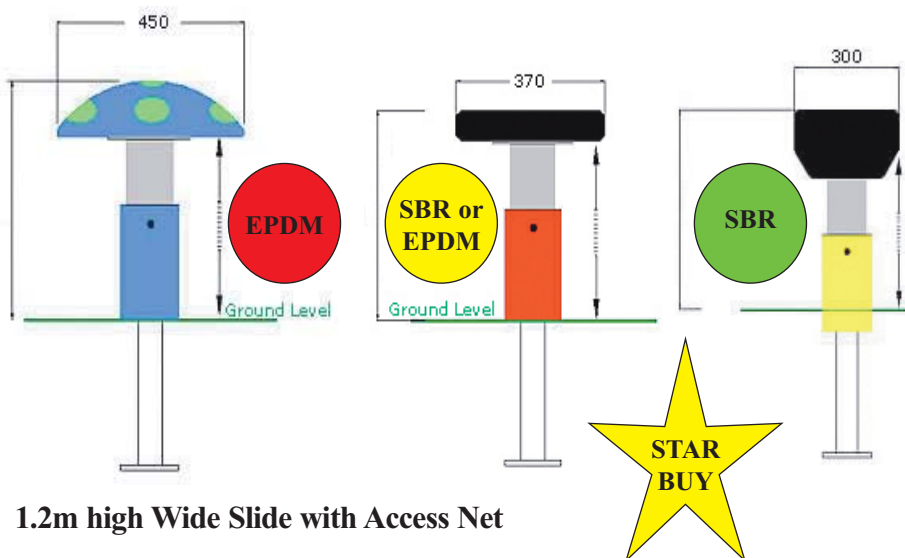

## 1.2m high Wide Slide with Access Net

The extra wide sliding surface allows carers or parents to slide with children if necessary.

Can aid in developing social skills as children can slide together.

Steel construction with single post platform

18mm Half Round Polydek Platform

16mm Polycord Access Net

Slide width 960mm

Ages 5+

Picture shown with access net but steps also available

Can also be manufactured to 1.0m & 1.5m deck heights



33m<sup>2</sup> @ 1.2m FFH

# New Equipment

## GIANT PENCILS

BRAND NEW Giant Coloured Pencils, ideal for creating a visual barrier to divide play areas or to highlight playground entrances/exits.  
Available in two heights, 2.4m and 2.0m, and 6 vibrant colours, purple, orange, green, red, blue and yellow

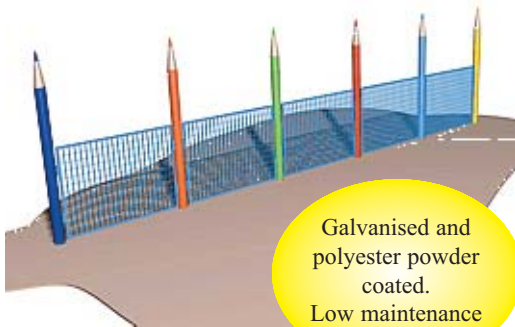

Galvanised and polyester powder coated.  
Low maintenance

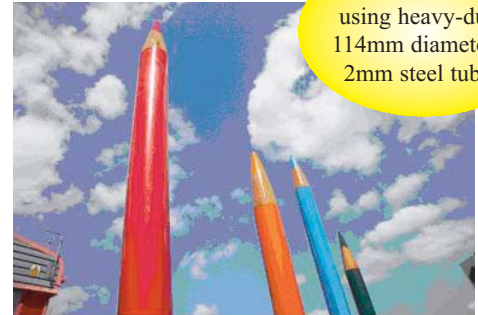

Posts are made using heavy-duty 114mm diameter x 2mm steel tubes

## SURFACE GAMES

### Premium Grade Wet Pour Hopscotch

10no 600mm x 600mm x 20mm EPDM tiles with coloured EPDM round edged squares with numbers 1-10 cut out. This allows the coloured tiles beneath to show through.

Wet Pour Hopscotch brings fun, excitement and education to any play zone, from parks & playgrounds to schools & nurseries.

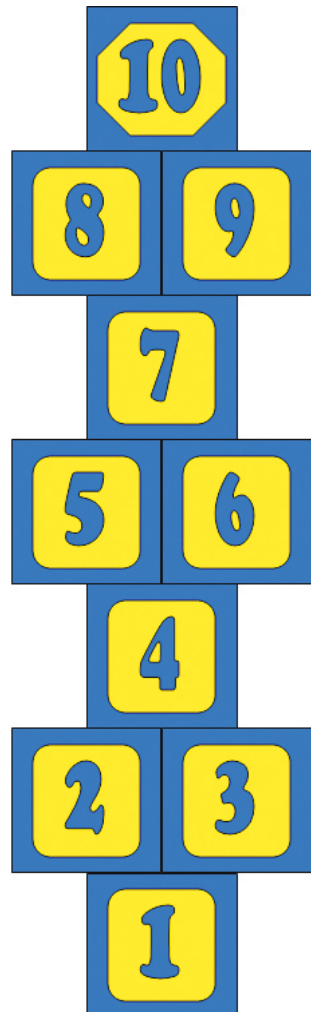

### Snakes & Ladders Tiles

9no 500mm x 500mm tiles numbered from 1-36 with 3 snakes & 3 ladders.

Available in a range of thickness's starting from 35mm.

These unique tiles can be used alone or incorporated into your playground design.

Available in SBR & EPDM rubber.

These attractive tiles bring fun & education to any outdoor area.

Snakes & Ladders is a time-honoured game, and when brought into the playground, helps develop interaction & social skills in even the youngest of users.

# New Equipment



**Jersey Seat**

Steel Seats and Benches are fully galvanised and powder coated



**Jersey Bench**



**Jersey Bin**



**Guernsey Bin**



**Wight Bin**

All litter bins come with a galvanised liner and locking device as well as the metal being fully galvanised and powder coated.



Due to the unique design our bollards are more robust, flexible and longer lasting than existing recycled plastic and wooden equivalents. Maintenance free and virtually graffiti and vandal resistant they are ideal for open spaces or roadside verges. The bollards have an integrally moulded galvanised steel core, are 1m in height and 150mm square.

Bollards and verge markers are all made using 90% recycled vehicle tyres and all steel reinforcing inserts are galvanised for long life.



These round bollards can be made from either black, green or red SBR rubber (recycled rubber) or brightly coloured EPDM rubber (virgin rubber).

### Ball Bollards

The spherical bollard has a diameter of 450mm and comes complete with a 114mm fully galvanised steel ground fixing, for permanent installation

**STAR BUY**



These spherical bollards are very long lasting and would cause less damage to a vehicle that may accidentally hit it than a metal or concrete alternative

They can also be made with small stone chippings for an alternative more natural effect

# Sail Shades

## The next big thing in sun protection!

With the growing awareness of global warming and skin cancer, the need to protect ourselves and our children from sun exposure is top priority.

We've decided to join the protection forces and proudly present to you "The Coolest Shades Under The Sun!"

From schoolyards & playgrounds to public play areas, pubs & hotels, Sail Shades are ideal for both permanent and temporary use to protect from strong rays from over exposure to the sun. They even come in DIY residential use form.



The unique construction of these Sail Shades ensures the fabric breathes, allowing hot air to pass through and thus significantly reducing temperatures underneath. Edges are reinforced using 50mm wide seat belt webbing with a distinctive corner bracket, constructed from 8mm stainless steel and zinc plated for maximum longevity.



Whether square or triangular, we can create a Sail Shade to suit your requirements. Once your posts/anchor posts have been set firmly into place, simply measure between the centres of the fixing points, including diagonals (see examples on page 20), give us the dimensions and we'll do the rest!



Sail Shades can also be supplied in various standard sizes for use in residential areas. The DIY shades come complete with fixings and instructions and are available in rectangular and triangular shapes and in a range of colours.



# Sail Shades

Fantastic for keeping cars cool in the hot weather!



A lot of people enjoy sitting outside the local pub in the afternoon but can't bear the heat from the sun. Here's a good looking solution! And with the No-Smoking Law upon us, they'll be appreciated in the rain too!



They can even be used inside too!

### Measuring Points

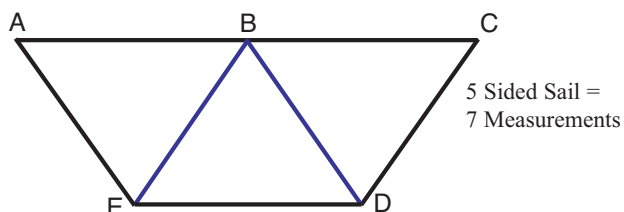
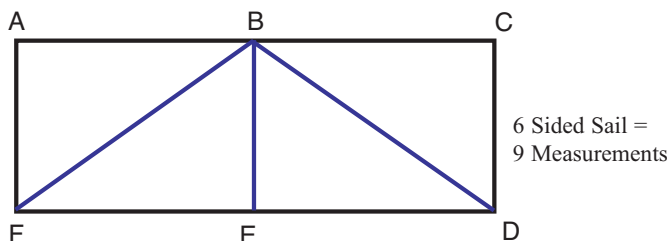
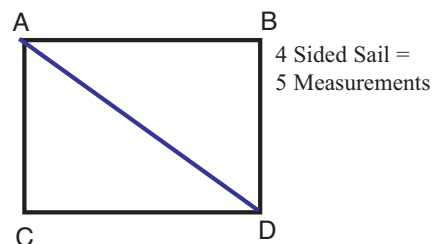
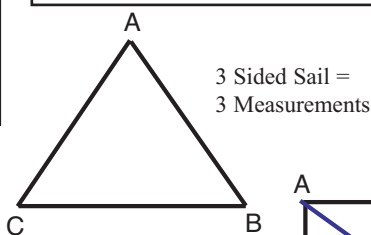

**Email: [sales@gb sportandleisure.co.uk](mailto:sales@gb sportandleisure.co.uk)**

# Safety Surfacing Accessories

## ARTIFICIAL GRASS SURFACING



In the unlikely event that the artificial grass surface becomes damaged, a cost effective quick and easy repair can be carried out on the affected areas. We have put together everything required to carry out repairs in our **BRAND NEW Artificial Grass Repair Kit**



**Hot Glue Gun**



**Stanley Knife**



**Nails**



**300m Adhesive Carrier Tape**



**Hot Glue Sticks**



**Seaming Iron**



**Artificial Grass Carpet**



**Carpet Rollers**

### Repair Kits

Glue Gun  
20 hot melt glue sticks  
(sufficient for 16-20m seaming at 6mm wide bead)  
4m x 1m Artificial Grass Carpet  
20m hot melt adhesive carrier tape  
Carpet Roller



### SAND

Kiln dried Silica Sand, particle size 0.1 – 1mm  
(NB silver sand / sand pit sand is not suitable as it is too fine)  
Also available in bulk!

# Wet Pour Safety Surfacing



For G.B. Sport & Leisure's treasured "hints and tips" for wet pour repairs, why not inquire about our NEW and INVALUABLE Groundsman's Handbook See page 2 for further details

## Wet Pour Repair Kits

25kg Rubber 5kg Fast Cure Resin

Available from stock in the following colours:



Red



Blue



Yellow



Green

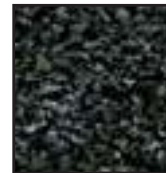

Black



Creteangle Mixers



## Rollers

for a professional finish



## Twin Outlet Transformer

1500KVA to BS3535  
2 x 16amp output sockets



## DeWalt Wet N Dry Vacuum

18 Volt  
1.9l tank capacity



## Cartridge Gun



## Gap Filler



## Paddles & Paddle Mixers

110v paddle mixer variable speed control



## DeWalt Reciprocating Saw & Saw Blades

Orbital action. 1200 watt motor for heavy duty applications. Variable speeds

Can't cut the rubber for repair? This will



## Primer

Helps bond new rubber to existing surface.



## Plastic Jugs

Helps when applying primer!



## Disposable Paint Brushes

For applying primer



## Stanley Knife

Essential to cut back existing surface in need of repair

## Plumbers Wrench

When trying to re-open a bottle of resin, this tool is a real help!



## Trowels

For levelling & smoothing



## Buckets

For soapy water for Professional trowelling



## Accelerator

Helps speed up the Wet Pour curing time

Check out page 33 for all your Personal Protection Requirements

# Safety Surfacing Accessories

## Safety Tiles & Gap Filling

### Tools required:

- Protective clothing
  - Dustpan & Brush
  - Disposable Paint Brushes
  - Mixer for Wet Pour Rubber
  - Bucket
  - Trowel
  - Container for Primer
- See page 17 for pictures and details

### Materials required:

- Gap Filler
- Primer
- Wet Pour rubber & resin
- Adhesive
- Water
- Washing up liquid

For G.B. Sport & Leisure's treasured "hints and tips" for gap filling, why not inquire about our NEW and **INVALUABLE** Groundsman's Handbook See page 2 for further details

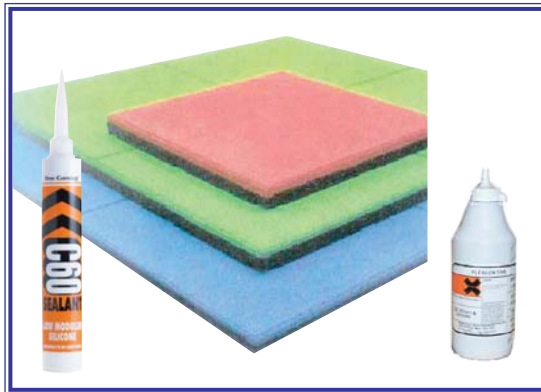

Replacement Tiles  
Gap Filler  
Primer

Wet Pour Repair Kits



### Playground Mulch

Soft, shredded and coloured loose fill material. Non toxic and offering excellent impact absorption (tested to BS1177). Cheaper to install and own.

### Rubber Bark



### Tree Rings

Circular, pre formed rubber mats, for the base of trees. Offering attractive, maintenance free protection.

### Kerb Stones

Pre formed slabs which sit on the ground to create a 'pit' and retain the rubber playground mulch.

### Tiles & Mats

A wide range of pre formed styles and shapes, including safety surfacing (tested to BS1177), patios, walkways.

### Playground Softbond

Playground mulch supplied loose then mixed with a binder and rolled to provide a fixed 'spongy tarmac' type surface which is safe and durable. Tested to EN1177.

### Landscaping Mulch

Soft shredded and coloured loose fill material providing permanent lasting aesthetics and long term cost effectiveness to planted areas.

### Lawn Edge

Pre formed strips of bonded rubber to provide an attractive, maintenance free mowing edge to lawns, planted areas, alongside fences etc.

# Safety Surfacing Accessories

## PLAY MATTA



Made from recycled products!



Requires no edgings as mats are supplied with rubber ramps

Play Matta provide a critical fall height of either 2.8m or 1.5m, dependant on the shock pad used



Play Matta is a colourful non-slip playground surfacing system that is designed to be fitted on top of any existing hard surface. The tiles are available in a range of colours enabling each installation to be customised to your design requirements

Play Matta brings vibrancy, colour and most importantly increased safety to all hard surfaced play areas. Unlike other forms of playground surfacing that require a concrete or wooden surround to contain the surface, Play Matta installations are fitted with ramped rubber edging. This allows easy access for wheelchair users and pushchairs whilst minimising the risk of trips and falls when entering or exiting the play area.

Play Matta's versatility means it can be fitted virtually anywhere including on slopes and is an ideal solution for installation over an existing play surface that is breaking up or has been vandalised.

- 1 Play Matta shock pads are laid over the existing hard surface
- 2 Weed barrier layer helps prevent weed growth on the installation
- 3 Play Matta are laid on top of the weed barrier
- 4 Edging ramps are fitted to all external edges of mats

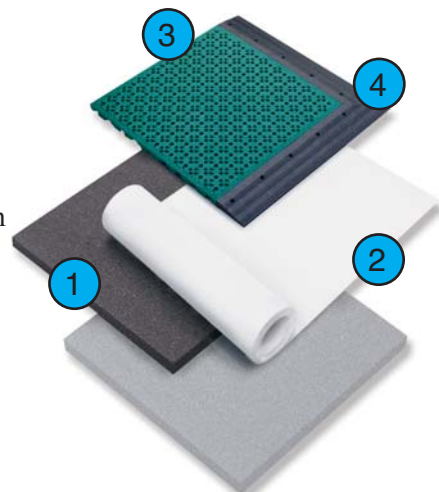

Email: [sales@gb sportandleisure.co.uk](mailto:sales@gb sportandleisure.co.uk)

# Safety Surfacing Accessories

## Wet Pour Graphics

Wet pour graphics can turn any wet pour surface into a new play aspect. You can have anything you like, from one small animal to an entire zoo, a couple of stars to a whole galaxy, or any graphics that your imagination desires! Adding number games, clocks etc can also provide extra learning fun!

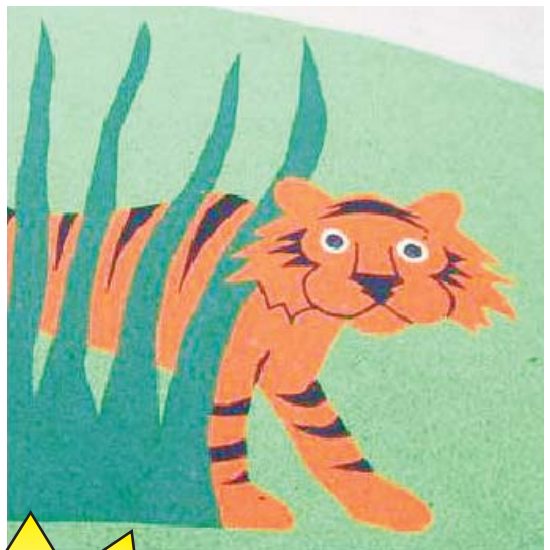

Try designing your own graphics or asking the children to create something they can call their own!



What about having your name put into the design?! Try having nursery rhymes or the alphabet in schools & nurseries to provide the children with a different way of learning & playing!



# Rubber Scrub

STAR  
BUY

*Rubber Scrub can immediately restore & refresh safety surfaces, transforming playgrounds into a safe & pleasant environment for our children.*



*Works on Tiles & Wet Pour!  
Graphics are restored to their original beauty*

*Using state-of-the-art hot water technology Rubber Scrub employs non-toxic, biodegradable additives to clean, kill mosses, algae and moulds and to remove general grime!*

*The original non-slip properties of the surface are restored and the appearance is greatly enhanced!*



*The specially formulated biocides also help prevent re-growth and maintain the cleanliness of the surface for up to 12 months.  
Play areas only need to be closed for a short period whilst cleaning takes place!*



**Email: [sales@gb sportandleisure.co.uk](mailto:sales@gb sportandleisure.co.uk)**

# Personal Safety



**Ear Defenders to EN352-1**  
Keep safe on site with our Ear Protection range. Suitable for light wear and heavier usage.



**Fibre Masks to EN149**  
Essential Respiratory Protection



**Safety Goggles to EN166**  
Keep your sight safe with our range of protective goggles and glasses



**Knee Pads**  
Range of Kneepads for maximum comfort on site



**Rubber & Vinyl Gloves**



**Barrier Cream**  
Essential hand protection



**First Aid Kits**  
Essential for the workplace, car, van and home



**Hard Hats to EN397 325g**  
High density polyethylene shell with adjustable comfort straps. Available in white and yellow



**Reflective Waistcoat**  
High Visibility Clothing, for when you need to be noticed. Available in sizes S, M, L, XL, XXL



**Reflective Jacket**  
High Visibility Clothing, for when you need to be noticed. Available in sizes S, M, L, XL, XXL



**Safety Boots**  
Steel Toe Cap  
Steel Midsole  
Rubber Outsole  
Lightweight & Flexible

The main requirement of the **PPE** at Work Regulations 1992 is that personal protective equipment is to be supplied and used at work wherever there are risks to health and safety that cannot be adequately controlled in other ways

# Site Safety

A huge range of site safety signs manufactured in 3mm aluminium composite panels with four colour laminated print to face. 450mm x 300mm or 500mm x 400mm and bi-lingual!

### Prohibition



### Warning



### Mandatory

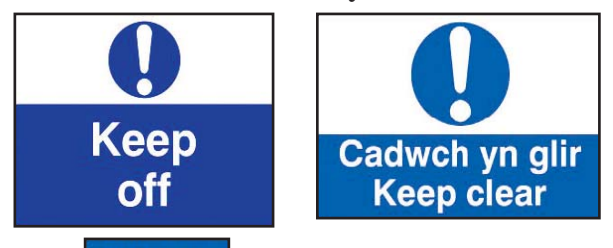

Site safety is imperative, keeping employees and the public safe during maintenance and site construction has to be top of the list!



# Inspections

We carry out site inspections complete with reports and maintenance schedules. Reports can include full colour pictures and diagrams to help explain safety risks. Maintenance schedules can be anything from one site once a year to all your sites weekly, whatever your requirements we can tailor a schedule to meet the needs of your Authority, the play area and it's users. For further information and prices please contact our sales office on:

**Tel: 0845 803 07 87.** Or email us @: [sales@gb sportandleisure.co.uk](mailto:sales@gb sportandleisure.co.uk)

EUROPEAN STANDARDS ADVICE EN1176 & EN1177  
 DESIGN & BUILD SERVICE  
 ANNUAL INSPECTION  
 BEST VALUE ASSESSMENT  
 SITE SURVEYS  
 QUARTERLY INSPECTIONS  
 DISABILITY DISCRIMINATION ASSESSMENT  
 RPII INSPECTOR

SAFETY SURFACING ADVICE  
 PLANNING APPLICATION ADVICE  
 POST INSTALLATION INSPECTION  
 PRODUCT ADVICE  
 CONTRACT MANAGEMENT  
 RISK ASSESSMENTS



**Probe set suitcase**  
An aluminium suitcase with handle to fit all 8 test probes



**Toggle Probe**



**Finger Probe**

**Test Probes**  
Set of 8 Test Probes



**Head and Neck Probes**

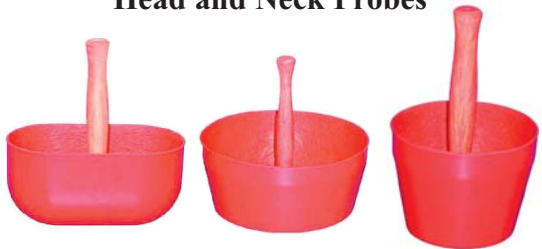

Inspections of all your play equipment and surfacing is vital. Take a look at what **DOES** happen when equipment is not inspected on a regular basis:



**Email: [sales@gb sportandleisure.co.uk](mailto:sales@gb sportandleisure.co.uk)**

# And Finally



Do you have copies of our play equipment and spares brochures? Do your maintenance teams need copies? Just give our sales office a call on **0845 803 07 87** and they will be more than happy to send you additional copies!

## SPARES BROCHURE

- Swing seats
- Chains
- Fittings
- Nuts & Bolts
- Cableways
- Ropes & Nets
- Spring Riders
- Seesaw Seats
- Paint
- Safety Surfacing
- Fencing, Gates & Accessories
- Landscaping & Amenity
- Signs, Security & Barriers
- Water Safety
- Playground Equipment
- Trim Trail and Timber Equipment
- Teenage Shelters



## PLAYGROUND EQUIPMENT BROCHURE

- Favourite Play
- Timber Play
- Special Play
- Safety Play
- Sport Play
- Skate Play
- Landscape

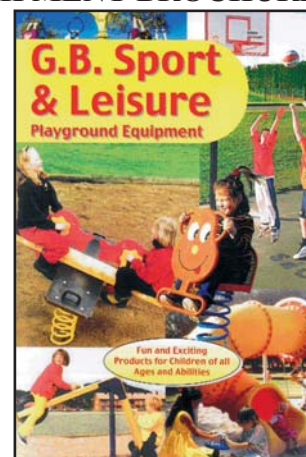

## Don't forget your **GROUNDSMAN'S HANDBOOK!**

- Measure chains correctly
- Hang chains and fit Varilinks
- Fit/remove seloc pins
- Fit/remove/check bushes
- Fit HDPE Panels
- Adjust gate springs
- Taking accurate site levels
- Fit Rocking Horse Seats
- Tension Aerial Runway Cables
- Using Heat Shrink Tape
- Safety surface repairs



Check out our website! See all our products and stay up to date with new products and promotions.

Go to: [www.gbsportandleisure.co.uk](http://www.gbsportandleisure.co.uk)

**Tel: 0845 803 07 87 Fax: 01934 612178**