

Ledon 2011 Play & Adventure

- Play structures • Slides • Tubes • Swings • Seesaws • Springers
- Balance items • Playhouses • Activity tables • Sandboxes



 **LEDON**[®]
Development through play

Safety and quality first...

All mesh is dimensioned to eliminate risk for getting stuck with your head or getting strangled.



Springs of special steel can bend into all directions. Intervals between the coils are made to eliminate the risk of getting your fingers stuck between them. Patented spring suspension with self locking nuts.



Our polyethylene panels are splinter-proof and there are no gaps at the junctions. No fingers, no clothes and no ribbons can get stuck or hurt.



All handles offer good grip and are rounded to reduce the risk of eye and dental injuries. All handles are made of nylon so that fingers can't freeze to them.



All stepping and sitting surfaces are coated with skid-proof rubber – compliments from the car industry.



All edges are rounded and all nuts are covered.



There is a steel inlay in our ropes, which makes them inherently stable and vandalism-proof. Our ropes do not get brittle or floppy.



All our items are certified IAW EN 1176:2009, which is reassuring for the adults. All playground equipment design is carried out without losing focus on safety.



Guarantee

5 years on material and product defects.
5 years guarantee against essential fading
on HDPE material.

"Quality means that things keep on being new."

Nynne, 6 years

Welcome to Ledon Play & Adventure



Contents

4

Playbus

5

Fire engine

6

Helicopter

7

KidsCar

8

Pirate Ship

10

Coaster

12

Sandboxes

13

Slides

14

Springers

Playbus



Top play value

- Invites to role play inside and outside the bus.
- Possibility for theme play for several children.
- Cute, appealing design that signals fun.

Top quality

- Maintenance free materials.
- Easy to mount and anchor.
- Splinter-proof and non-toxic PE-plates.
- UV-resistant colours.
- Sweet and inviting design.

All aboard! The 2 to 5 year olds will all play together when they boom away in this cute bus. It will become the playground's new inviting playhouse where children will gather.

Easy to mount and set up
– no maintenance.

Product dimensions

Item 1901

Dimensions (cm) L 183 x W 94 x H 143

Required space: 483 x 394

Climbing height: 59

Age group: From 2 years

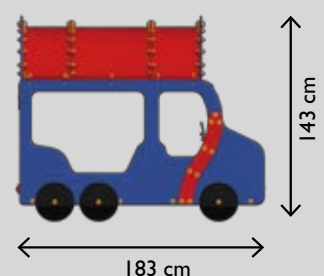

Fire engine



Now this one is hot! The fire must be put out quickly, and there is room enough for lots of brave firemen and – women!

The springs make the blustering vehicle more alive.

Quick and easy mounting
– no fall protection required.



Product dimensions

Item 1701

Dimensions (cm) L 152 x W 127 x H 156

Required space: 452 x 427

Climbing height: 59

Age group: From 2 years

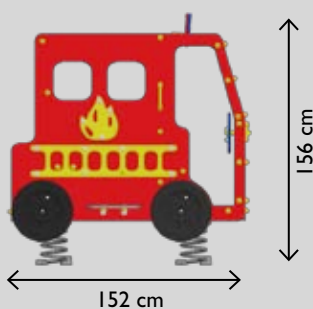

Top play value

- Room for many children.
- Play area for both quiet and active children.
- Rocking springs make the play feel more real.
- Many smart details that fire the children's imagination.
- Several can join in theme play.

Top quality

- Easy to mount and set up.
- Anti-slip surfaces on all horizontal boards.
- Splinter-proof and non-toxic PE-plates.
- No fall protection required
- Maintenance-free materials.
- Patented, long-lasting spring construction.
- With or without springs – suitable for both outdoor and indoor use.

Helicopter



Advantages:

- Galvanized, stainless steel tubes.
- Easy to mount and anchor.
- Doesn't require fall protection.
- Unbreakable polycarbonate dome.

Sales-increasing arguments:

- Attractive price.
- Radically new product with only few competing products.
- Big customer potential.
- Easy marketing because of its colours and name.

A new classic, which will make the kids' imagination overspeed and take the 3 to 8 year olds to "the sky".

Product dimensions

Item 1750

Dimensions (cm) L 302 x W 144 x H 247

Required space: 602 x 444

Climbing height: 59

Age group: From 2 years

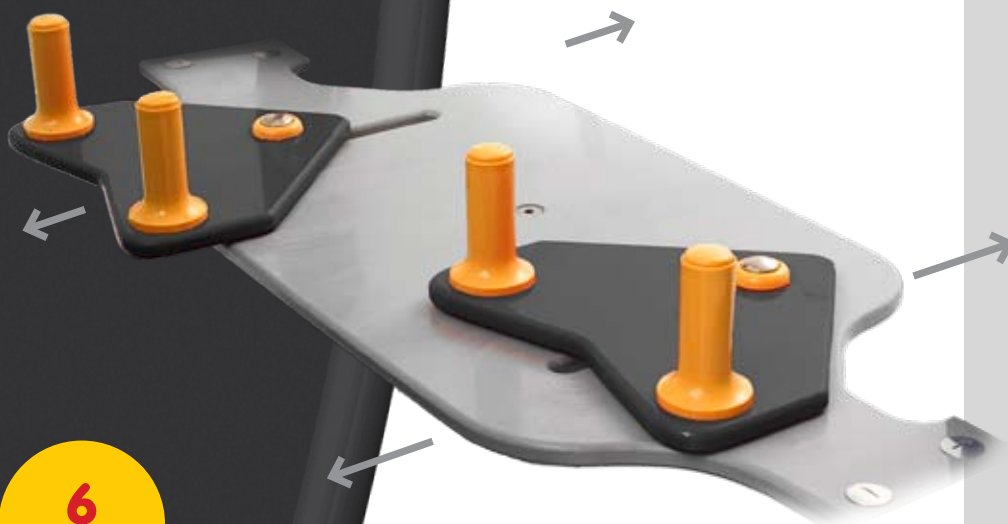

KidsCar



Cute and funny vehicle which in the children's imagination can be anything from a 4x4 to a tractor. Room for up to 6 children. Movable parts on the dashboard. Made of maintenance-free PE. Choose between red and green.

Product dimensions

Item 1710 / 1712

Dimensions (cm) L 133 x W 110 x H 119

Required space: 433 x 410

Climbing height: 59

Age group: From 2 years

Top play value

- Movable parts on the dashboard and room for 3 children invite to roleplay.
- Table and chair in the back can be part of the vehicle or a playhouse of its own for 3 children.
- Heaps of possibilities for 6 children, little space required.

Top quality

- Skid-proof coating on all standing surfaces.
- Made of maintenance-free polyethylene.
- No safety surface required.
- UV-proof colours.

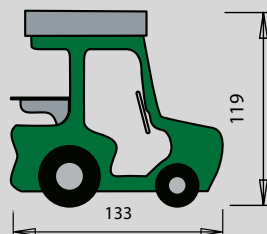

Pirate Ship

- Many movable parts on the bridge and a number board on its rear challenge children's motor and intellectual skills.
- Bright colours and so many attractive details make the kids go WOW!
- A world of options for up to 10 children within limited space.

Click - Click

Pump
(moveable)

Engine room
(moveable)

Optional:
Open slide
(PE gliding surface)

Steering wheel &
compass
(moveable)

Sea chart & ships
(moveable)

2 telescopes
(moveable)

Pirate Ship



Number board (moveable)



Optional: Tube slide

Optional: Stairs (Steps covered with rubber coating)

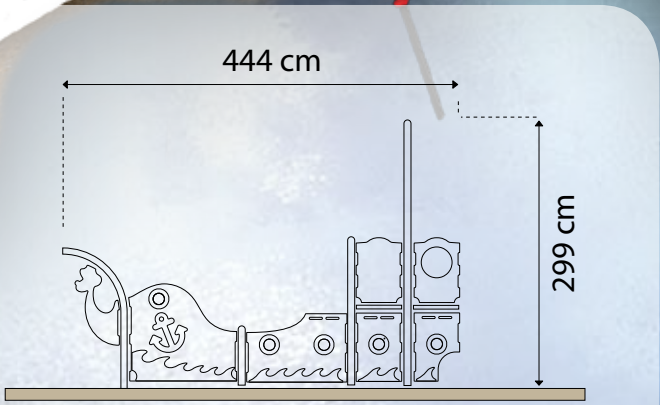

Dimensions in cm: L 444 x W 250 x H 299

Coaster

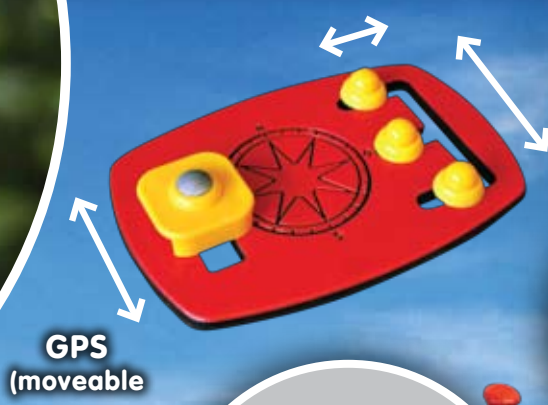

GPS (moveable)

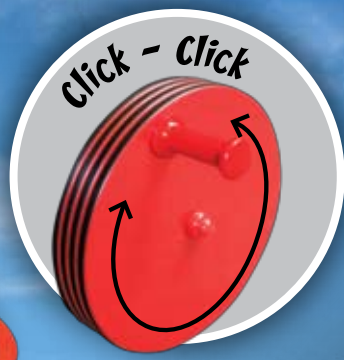

Click - Click

Pump (moveable)

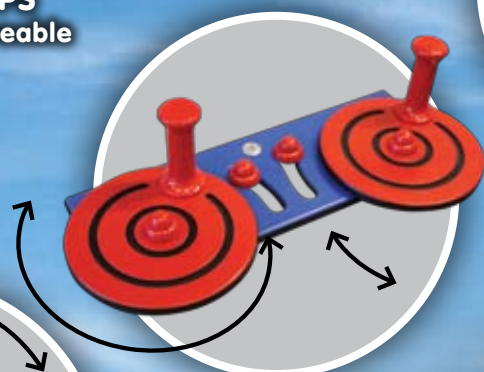

Engine room (moveable)

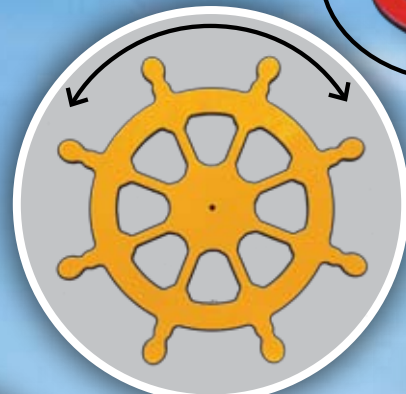

Steering wheel & compass (moveable)



Sea chart & ships (moveable)



2 telescopes (moveable)



Optional: Open slide (PE gliding surface)



- Many movable parts on the bridge and a number board on its rear challenge children's motor and intellectual skills.
- Bright colours and so many attractive details make the kids go WOW!
- A world of options for up to 10 children within limited space.

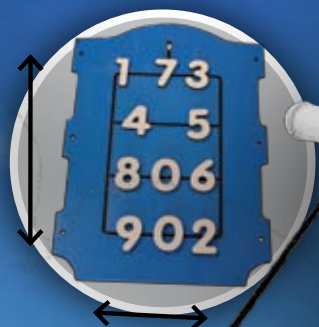

Number board (moveable)

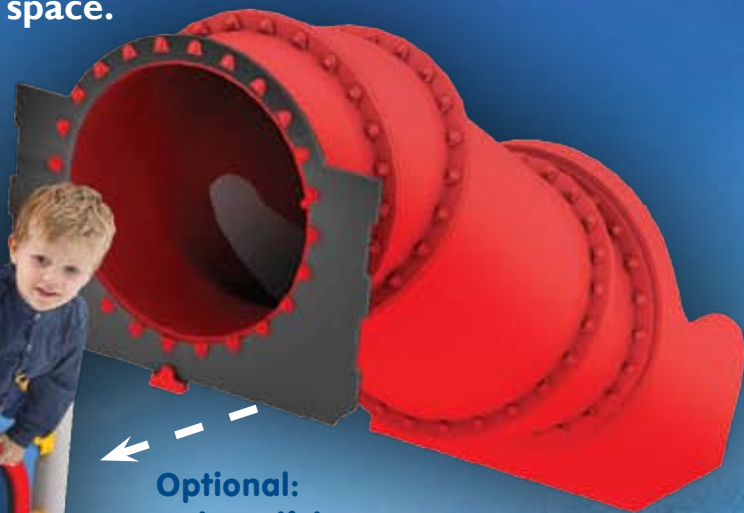

Optional: Tube slide

Optional: Stairs (Steps covered with rubber coating)

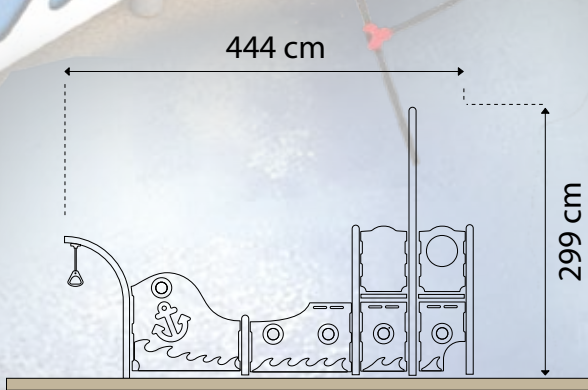

Dimensions in cm: L 444 x W 250 x H 299

Sandboxes



Activity table

-  Item: 1595
-  Item: 1592
-  Item: 1593

Diameter: 59 cm
Height: 60 cm
Age group:
From 2 years



Sandbox with 6 modules

Item: 1460
 Dimensions in cm: L 270 x W 236
 Height: 16/30 cm
 Age group: 1-8 years

Sand box with 8 modules

Item: 1440
 Dimensions: L 270 x W 270
 Height: 16/30 cm
 Age group: 1-8 years

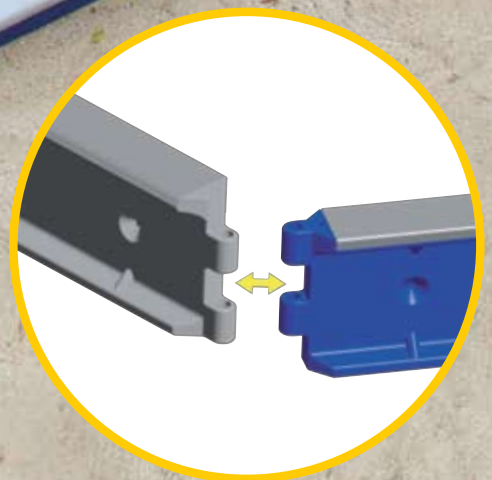

Flexible modular system

You can build your own sandbox by freely combining our 130 cm long modules. The parts can easily be joined and mounted - also on concrete/bitumen.

Example sandbox with 12 modules:

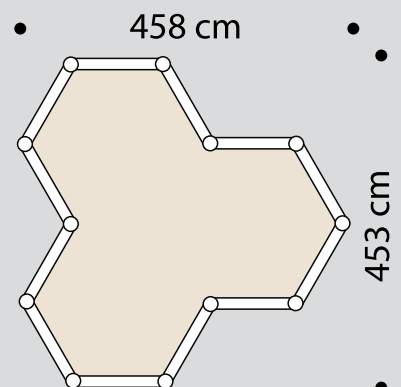

- Made of injection cast, rot-proof PE
- Absolutely maintenance-free
- Skid-proof surfaces - also in wet weather
- Shape and size can be changed later

Slides



Our slides offer exciting fun to children of all ages when-ever classic play needs an extra challenge.

Access via climbing wall, climbing rope or stairs.

Open slides and tube slides are both made of maintenance-free (PE) polythylene - also gliding surface.

Product information for Octopus slide

Item 1981 - 1982 - 1985

Dimensions (cm) L 256 x W 52 x H 167

Required space: 606 x 350

Climbing height: 90

Safety surface: IAW EN 1177

Age group: From 2 years

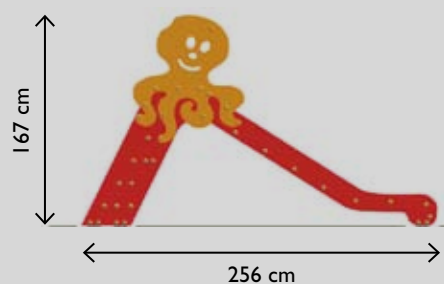

Slides support children in developing their ability to judge distances and speed and challenges their motor skills. Slides can be placed solitarily on a playground, or they can be part of one of our many play systems. We can supply you with open slides or tube slides.

- Different kind of excitement - and speed!
- Fun play for children of many ages.
- Can be installed indoors and outdoors.
- Solitary or part of play system.

Springers



CAR

Item: 475

Dimensions (cm): L 74 x W 40 x H 73

Required space: 274 x 240 cm

Seat height: 45 cm

Age group: From 1 year

Ledon offers many different kinds of springers - to suit basically every child's taste.

Springers increase the children's pulse rate and spur their imagination. They provide safe balance stimulation for one, two or more children. Our springs can endure even the wildest riders.

- Easy to mount
- Optional backrest available for special need children.
- Non-slip seats
- Splinter-free polyethylene plate that neither cracks nor bleaches
- Patented spring suspension with self-locking nuts

Motorbike



Product dimensions

MOTORBIKE Item 414

84 cm

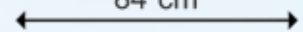

35 cm

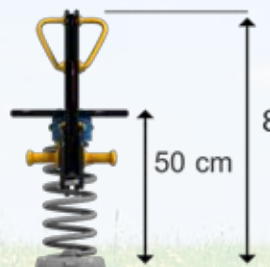
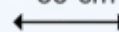

80 cm

50 cm

Dimensions (cm) L 84 x W 35 x H 80

Required space: 284 x 235

Seat height: 50 cm

Age group: From 2 years



WHALE

Item: 482

Dimensions (cm): 185 x W 38 x H 78

Required space: 285 x 238 cm

Seat height: 45 cm

Age group: From 1 year

Sun Seesaw

with maintenance free
aluminium bar

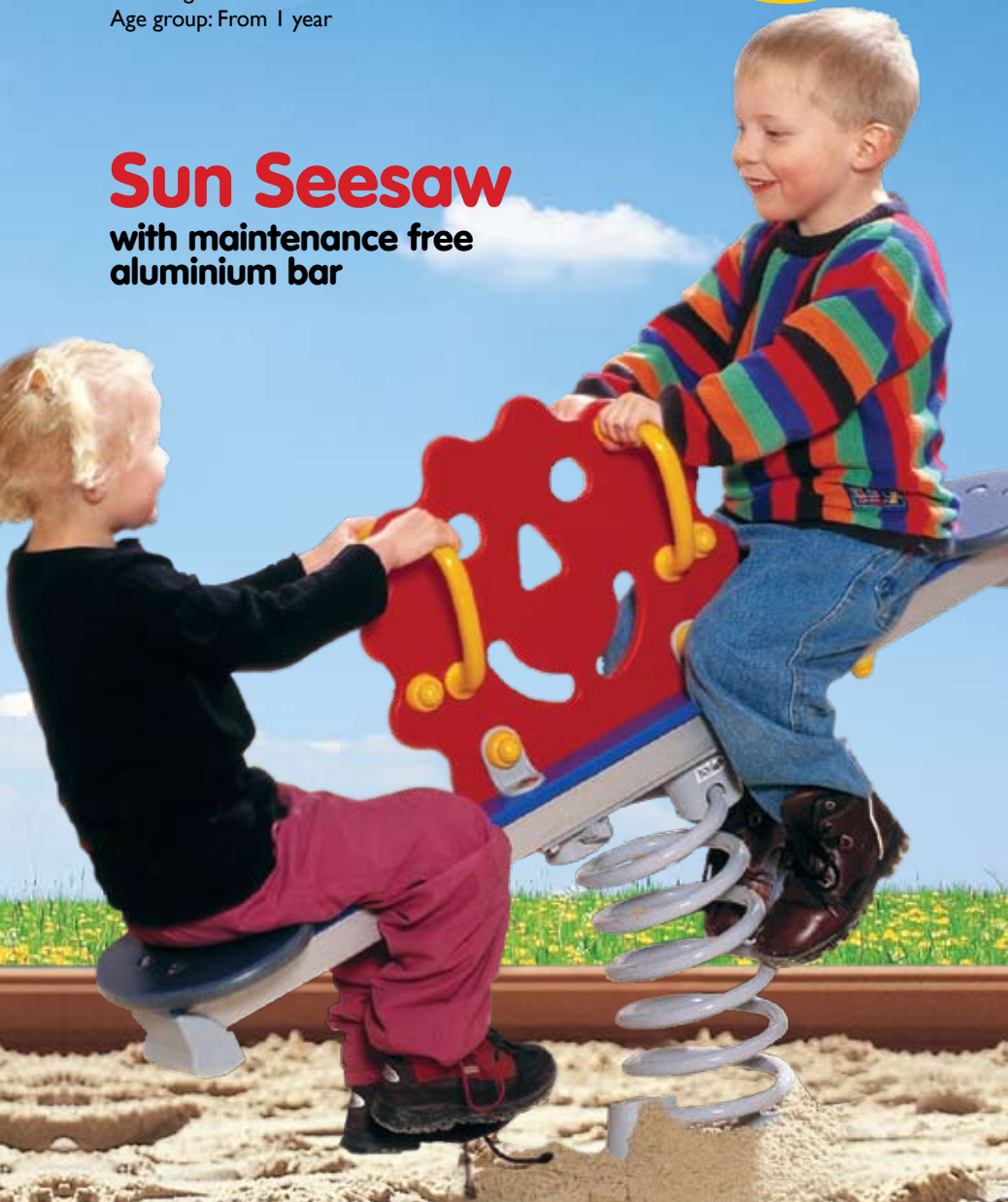

Product dimensions

SUN SEESAW Item 442

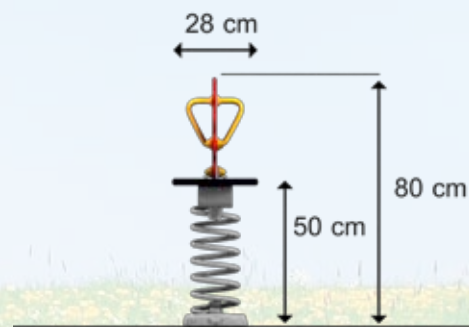
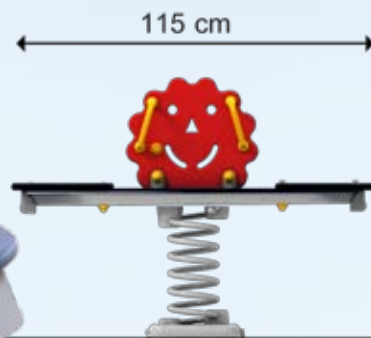

Dimensions (cm) L 115 x W 28 x H 80

Required space: 415 x 328

Seat height: 50 cm

Age group: From 2 years

Safety surface: IAW EN 1177

