TECHNE

TC-3000G

OPERATOR'S MANUAL

CONTENTS

	PAGE
INTRODUCTION	1
SAFETY AND INSTALLATION	2
SÉCURITÉ ET CONSIGNES D'INSTALLATION	5
SICHERHEITS- UND INSTALLATIONSINFORMATIONEN	8
INFORMAZIONI SULLA SICUREZZA E L'INSTALLAZIONE	11
INFORMACIÓN DE SEGURIDAD E INSTALACIÓN	14
BEFORE SWITCHING ON	16
CONTACT INFORMATION	17
TC-3000G SPECIFICATION	18
USER OPERATION AND CONSUMABLES	20
Heated lid	20
Tubes or reaction vessels	20
0.5ml tubes	21
Switching on	21
FRONT PANEL CONTROLS	22
The LCD display	22
Indicators	22
The keys	23
PROGRAMMING THE TC-3000G	24
Programming Options	25
Option 1: Creating programs using templates	25
Option 2: Creating a new program	29
Example programs	30
Programming	30
To program a gradient	34
To program increment or decrement temperature or time	37
To run a program	40
INFORMATION	42
CONFIGURATION	42
GRADIENT CALCULATOR	46
RUNNING THE TC-3000G FROM A PC	47
Connecting one unit to a PC	47
Connecting several TC-3000G units to a PC	47
NOTES ON TRANSFERRING PROTOCOLS FROM OTHER THERMAL CYCLERS	48
USER MAINTENANCE	49
Cleaning your TC-3000G	49
Heater block removal	49
SOME FREQUENTLY ASKED QUESTIONS	50
ADDITIONAL INFORMATION	51
Fault Finding	51
Fuses	51
The heated lid over-temperature cut-out	51
Insulation testing	51
Interchangeable blocks	51
Accessories	52
Replacement parts	53

INTRODUCTION

The TC-3000G provides the researcher with the means of accurately controlling the temperature profile of samples. It has many scientific applications, including PCR¹ and sequencing. The unit can cycle samples between 4°C and 99°C.

The TC-3000G is programmed by means of an integral keypad and LCD display. A program, which can be recalled from memory, consists of:

- a series of specified temperatures in °C.
- the times for which each specified temperature will be held (Hold Times).
- the desired heating or cooling rates, in °C/sec, between each specified temperature.
- optional gradient of temperatures across the heater block.
- optional instructions as to whether the times and/or the temperatures are to increase or decrease when a cycle is repeated.

The memory can store up to 80 programs.

Before using the thermal cycler, make sure you have read this manual carefully. If there is any doubt relating to the proper use of this equipment, the staff at Bibby Scientific Ltd or your supplier will be happy to assist you.



¹Purchase of this instrument conveys a limited non-transferable immunity from suit for the purchaser's own internal research and development and applied fields other than human in-vitro diagnostics under non-real-time thermal cycler patents of Applied Biosystems LLC.

SAFETY AND INSTALLATION

OPERATOR SAFETY

Please read this manual carefully before using the thermal cycler. If the equipment is not used in the manner described in this manual the protection provided by the equipment might be impaired.

All Bibby Scientific Ltd instruments are designed to conform to international safety requirements and are fitted with an over-temperature cut-out. If a safety problem should be encountered then switch off the unit at the mains socket and remove the plug from the electricity supply.

WARNING

HIGH TEMPERATURES ARE DANGEROUS as they can cause serious burns to operators and ignite combustible material. Users should be aware of the following potential hazards:



- USE CARE AND WEAR PROTECTIVE GLOVES TO PROTECT HANDS
- DO NOT use combustible substances near hot objects
- DO NOT operate the instrument in the vicinity of inflammable liquids or gases
- DO NOT place any liquid directly into the instrument, always use the appropriate plastic consumables

After heating samples, remember that parts of the instrument, namely the lid and block and any associated accessories may be very hot.

UNPACKING

When unpacking please ensure that the following have been removed from the packaging:

- Thermal cycler
- Mains cable
- Guarantee card
- Decontamination certificate

The user is advised to keep the original packaging in case the instrument ever needs to be returned for service or repair. Bibby Scientific Ltd accepts no responsibility for damage incurred unless the unit is correctly packed and transported in its original packaging.

Please note that the screen of the thermal cycler is easily damaged by sharp objects such as pens, pencils and fingernails. This type of damage will be considered as misuse and invalidate the guarantee for this component.

INSTALLATION

The instrument should be carried using both hands. Never move or carry the instrument when in use or connected to the mains electricity supply.

1. All Bibby Scientific Ltd instruments are supplied with a power cable; this may be integral or plug-in.
2. The TC-3000G has a switch-mode power supply which is suitable for use with universal AC input

voltages between 90 and 260V. Connect the mains cable to a suitable plug according to the table below.

Connections	220V-240V, 50/60Hz Supply	110V-120V, 50/60Hz Supply
Live	brown	black
Neutral	blue	white
Earth	green/yellow	green

3. UK ONLY: The fused plug supplied with the mains cable is fitted with a 10 Amp fuse to protect the instrument and the user.
4. Plug the mains cable into the socket on the back of the instrument.
5. Place the unit on a suitable flat bench or in a fume cupboard if required, ensuring that the air inlet vents on the underside are free from obstruction. Position the instrument with a minimum distance all round of 200mm from walls or other items and between each unit if multiple units are being used to permit efficient air flow for each instrument.
6. Switch on the instrument:
 - mains switch On
 - mains switch Off

Replacement cable

Should the mains lead need replacement, a cable of 1mm² of harmonized code H05VV-F connected to an IEC320 plug should be used. **IF IN DOUBT CONSULT A QUALIFIED ELECTRICIAN.**

WORKING CONDITIONS

The thermal cycler is designed operate under the following conditions:

- Indoor use
- Ambient temperature range +5°C to +40°C
- Altitude to 2000m
- Up to 95% relative humidity, non-condensing
- Mains supply fluctuations not exceeding 10%
- Over voltage category II IEC 60364-4-443
- Pollution degree 2

Note: The control specifications are quoted at an ambient temperature of 20°C. The specification may deteriorate outside an ambient temperature of 10°C to 30°C.

The instrument has been tested for radio frequency interference and is certified under EN61326.

GUARANTEE

The instrument is guaranteed against any defect in material or workmanship for the period specified on the enclosed guarantee card. This period is effective from the date of purchase; within this period all defective parts will be replaced free of charge provided that the defect is not the result of an accident, misuse or negligence. The screen of the thermal cyclers can be damaged by sharp objects such as pens, pencils and fingernails. Damage of this sort will be considered misuse and will invalidate the guarantee for this component.

Servicing under this guarantee should be obtained from the supplier of the instrument.

This manual has been prepared for the convenience of Bibby Scientific Ltd's customers and nothing in this manual shall be taken as a warranty, condition or representation concerning the description, merchantability, fitness for purpose or otherwise of the unit or components.

Notwithstanding the description and specification(s) of the instruments contained in the operator's manual, Bibby Scientific Ltd reserves the right to make such changes as it sees fit to the instruments or to any of the components.

SÉCURITÉ ET CONSIGNES D'INSTALLATION

SÉCURITÉ DE L'OPÉRATEUR

Lire attentivement le présent manuel avant d'utiliser le cycleur thermique. Si ce matériel n'est pas utilisé de la manière décrite dans le présent manuel, la protection fournie risque d'être compromise.

Tous les appareils Bibby Scientific Ltd sont conçus pour être conformes aux exigences internationales de sécurité et sont dotés d'une coupure en cas de surchauffe. Si un problème de sécurité survient, mettre l'appareil hors tension au niveau de la prise secteur et débrancher la fiche de l'alimentation électrique.

AVERTISSEMENT

Les TEMPÉRATURES ÉLEVÉES SONT DANGEREUSES car elles peuvent provoquer de graves brûlures chez l'opérateur et enflammer les matériaux combustibles. Les utilisateurs devront être conscients des dangers potentiels suivants :



- AGIR AVEC PRUDENCE ET PORTER DES GANTS DE PROTECTION POUR LES MAINS
- NE PAS utiliser de substances combustibles à proximité d'objets chauds
- NE PAS utiliser l'appareil au voisinage de liquides ou de gaz inflammables
- NE PAS placer un quelconque liquide directement sur l'appareil; toujours utiliser les consommables en plastique appropriés

Rappel : après le chauffage d'échantillons, certaines parties de l'appareil, notamment le couvercle et le bloc, ainsi que les accessoires associés, peuvent être brûlants.

DÉBALLAGE

Au moment du déballage, vérifier que l'emballage contenait les articles suivants :

- Cycleur thermique
- Câble secteur
- Carte de garantie
- Certificat de décontamination

Il est conseillé à l'utilisateur de conserver l'emballage d'origine s'il devait s'avérer nécessaire de renvoyer l'appareil pour une intervention d'entretien ou de réparation. Bibby Scientific Ltd n'accepte aucune responsabilité pour les dégâts survenus si l'appareil n'est pas correctement emballé et transporté dans son emballage d'origine.

Noter que des objets pointus tels que crayons, stylos et ongles peuvent facilement endommager l'écran du cycleur thermique. Ce type de dégâts sera considéré comme une mauvaise utilisation et annulera la garantie de ce composant.

INSTALLATION

Porter l'appareil à deux mains. Ne jamais déplacer ou transporter l'appareil lorsqu'il est en service ou branché à l'alimentation électrique sur secteur.

1. Tous les appareils Bibby Scientific Ltd sont livrés avec un câble d'alimentation, qui peut être intégré à l'appareil ou muni d'une fiche.
2. Le TC-3000G a une alimentation électrique avec un sélecteur de tension qui vous permet un choix entre 90 et 260V. Reliez le câble d'alimentation à une prise appropriée selon la table ci-dessous.

Connexions	Alimentation 220V-240 V, 50/60 Hz	Alimentation 110V-120 V, 50/60 Hz
Phase	marron	noir
Neutre	bleu	blanc
Terre	vert/jaune	vert

3. ROYAUME-UNI SEULEMENT: La prise à fusible fournie avec le câble secteur est munie d'un fusible 10 A destiné à protéger l'appareil et l'utilisateur.
4. Brancher le câble secteur dans la prise au dos de l'appareil.
5. Disposer l'appareil sur une paillasse ou sous une hotte aspirante si nécessaire, en veillant à ce que les prises d'air situées au-dessous ne soient pas obstruées. Positionner l'appareil avec tout autour un écartement minimum de 200 mm par rapport aux murs ou autres éléments, ainsi qu'entre chaque appareil en cas d'utilisation d'appareils multiples, afin de permettre une circulation d'air efficace pour chaque appareil.
6. Allumer l'appareil.
 - Interrupteur secteur en position Marche
 - Interrupteur secteur en position Arrêt

Câble de rechange

S'il s'avère nécessaire de remplacer le cordon secteur, utiliser un câble de 1 mm² au code harmonisé H05VV-F raccordé à une fiche IEC320. **EN CAS DE DOUTE, CONSULTER UN ÉLECTRICIEN QUALIFIÉ.**

CONDITIONS DE TRAVAIL

Le cycleur thermique est conçu pour fonctionner dans les conditions suivantes:

- Utilisation en intérieur
- Plage de température ambiante : +5°C à +40°C
- Altitude jusqu'à 2000 m
- Au-dessus de 95% d'humidité relative, pas de condensation
- Fluctuations de l'alimentation sur secteur ne dépassant pas 10%
- Surtensions de catégorie II selon la norme IEC 60364-4-443
- Degré de pollution 2

Remarque: Les caractéristiques de régulation sont indiquées à une température ambiante de 20°C. Ces caractéristiques peuvent se détériorer en dehors d'une température ambiante de 10°C à 30°C.

L'appareil a été testé en matière de perturbations radioélectriques et est certifié selon la norme EN61326.

GARANTIE

L'appareil est garanti contre tout défaut de matériaux ou vice de fabrication pendant la période précisée sur la carte de garantie jointe. Cette période s'applique à compter de la date d'achat; pendant cette période, toutes les pièces défectueuses seront remplacées gratuitement à condition que le défaut ne soit pas le résultat d'un accident, d'une mauvaise utilisation ou d'une négligence. Des objets pointus tels que crayons, stylos et ongles peuvent endommager l'écran du cycleur thermique. Les dégâts de cette sorte seront considérés comme une mauvaise utilisation et annuleront la garantie de ce composant.

Dans le cadre de cette garantie, le service après-vente est à obtenir auprès du fournisseur de l'appareil.

Le présent manuel a été préparé pour le confort des clients de Bibby Scientific Ltd et rien dans son contenu ne doit être pris comme une garantie, une condition ou une affirmation concernant la description, la qualité marchande, l'adéquation à un usage particulier ou autre de l'appareil ou de ses composants.

Nonobstant la description et les caractéristiques techniques des appareils figurant dans le manuel de l'utilisateur, Bibby Scientific Ltd se réserve le droit d'apporter aux appareils ou à n'importe quel composant les changements jugés utiles.

SICHERHEITS - UND INSTALLATIONSINFORMATIONEN

SICHERHEIT DES BEDIENPERSONALS

Lesen Sie diese Anleitung vor Verwendung des Thermocyclers bitte sorgfältig durch. Wenn das Gerät nicht entsprechend der Bedienungsanleitung eingesetzt wird, können die Schutzfunktionen des Gerätes beeinträchtigt werden.

Alle Geräte von Bibby Scientific Ltd entsprechen den internationalen Sicherheitsanforderungen und sind mit einer Übertemperatur-Schutzvorrichtung ausgestattet. Bei einer Sicherheitsstörung bitte das Gerät an der Steckdose ausschalten und den Netzstecker ziehen.

ACHTUNG

HOHE TEMPERATUREN STELLEN EINE GEFAHRENQUELLE DAR. Sie können schwere Brandverletzung verursachen und brennbare Stoffe entzünden. Der Benutzer sollt sich mit den möglichen Gefahren vertraut machen:



- UMSICHTIG VORGEHEN UND SCHUTZHANDSCHUHE TRAGEN
- KEINE brennbaren Stoffe in der Nähe heißer Gegenstände verwenden
- Das Gerät NICHT in der Nähe entzündlicher Flüssigkeiten oder Gase betreiben
- Flüssigkeiten NICHT direkt auf das Gerät auftragen - verwenden Sie stets die entsprechenden Kunststoffeinsätze

Nach der Erhitzung von Proben daran denken, dass bestimmte Geräteteile wie Deckel, Thermoblock und Zubehörteile sehr heiß sein können.

AUSPACKEN

Beim Auspacken darauf achten, dass der folgende Lieferumfang vorhanden ist:

- Thermocycler
- Netzkabel
- Garantiekarte
- Dekontaminationszertifikat

Wir empfehlen die Originalverpackung aufzubewahren, falls das Gerät zwecks Wartung oder Reparatur zurückgeschickt werden muss. Bibby Scientific Ltd übernimmt keine Verantwortung für Transportschäden, wenn das Gerät nicht ordnungsgemäß verpackt in der Originalpackung verschickt wird.

Achten Sie bitte darauf, dass die Anzeige des Thermocyclers durch spitze bzw. scharfe Gegenstände wie Stifte, Bleistifte und Fingernägel leicht zerkratzt wird. Diese Art von Beschädigung gilt als Missbrauch des Geräts und führt zur Ungültigkeit der Garantie für dieses Gerät.

INBETRIEBNAHME

Das Gerät mit beiden Händen tragen. Das Gerät unter keinen Umständen transportieren, wenn es in Betrieb ist, oder während das Gerät noch am Netz angeschlossen ist.

1. Alle Geräte von Bibby Scientific Ltd werden mit einem Netzkabel geliefert, das entweder eingesteckt wird oder fest mit dem Gerät verbunden ist.
2. Der TC3000G hat einen Switch-Mode Power Supply, der mit universellen AC Eingangsspannungen zwischen 90 und 260V genutzt werden kann. Schliessen Sie das Netzkabel an eine geeignete Steckdose an, entsprechend der unten aufgeführten Tabelle.

Anschluss	220/240V, 50/60Hz	110V/120V, 50/60Hz
Phase	Braun	Schwarz
Neutral	Blau	Weiß
Erde	Grün/Gelb	Grün

3. NUR FÜR GROSSBRITANNIEN: der mit dem Netzkabel gelieferte Sicherungsstecker enthält eine 10 Amp. Sicherung zum Schutz des Geräts und des Anwenders.
4. Stecken Sie das Netzkabel in die Buchse auf der Geräterückseite ein.
5. Stellen Sie das Gerät auf einen geeigneten ebenen Tisch oder in einem Abzugsschrank auf und sorgen Sie dafür, dass die Lufterlassschlitze auf der Geräteunterseite nicht blockiert sind. Das Gerät muss einen Mindestabstand von 200 mm zu Wänden und anderen Gegenständen bzw. zu anderen Geräten dieser Art aufweisen, um einen ausreichenden Luftstrom zu gewährleisten.
6. Schalten Sie das Gerät ein:
 - Netzschalter Ein
 - Netzschalter Aus

Ersatzkabel

Bei einem eventuellen Austausch des Netzkabels wird ein Kabel vom Typ H05VV-F mit 1mm² Adernquerschnitt und Europastecker (IEC 320) benötigt. **IM ZWEIFELSFALL EINEN ELEKTROFACHMANN HINZUZIEHEN.**

EINSATZBEDINGUNGEN

Der Thermocycler ist für den Einsatz unter folgenden Bedingungen ausgelegt:

- Gebrauch in Innenräumen
- Umgebungstemperatur zwischen +5°C to +40°C
- Höhe: bis zu 2000 m
- Relative Feuchte nicht über 95%
- Netzspannungsschwankungen nicht über 10%
- Überspannungsklasse 2 IEC 60364-4-443
- Verschmutzungsgrad 2

Hinweis: Die Gerätespezifikationen beziehen sich auf eine Umgebungstemperatur von 20°C und können sich außerhalb des Bereichs 10°C bis 30°C verschlechtern.

Das Gerät wurde auf HF-Störeinflüsse geprüft und entspricht den EMV-Bedingungen nach EN61326.

GARANTIE

Bibby Scientific Ltd gewährleistet, dass dieses Gerät für den auf der Garantiekarte angegebenen Zeitraum keine Herstellungs- und Materialmängel aufweist. Dieser Zeitraum tritt ab dem Verkaufsdatum in Kraft. Innerhalb dieses Zeitraums werden alle defekten Teile kostenlos ausgetauscht, soweit der Defekt nicht auf einen Unfall, Missbrauch oder Nachlässigkeit zurückzuführen ist. Die Anzeige des Thermocylers kann durch spitze/scharfe Gegenstände wie Stifte, Bleistifte und Fingernägel beschädigt werden. Diese Art von Beschädigung gilt als Missbrauch des Geräts und führt zur Ungültigkeit der Garantie für dieses Gerät.

Wartungsarbeiten, die unter diese Garantie fallen, müssen von der Verkaufsstelle für dieses Gerät gehandhabt werden.

Diese Anleitung wurde zur Information der Kunden von Bibby Scientific Ltd erstellt und stellt in keinsten Weise eine Gewährleistung, Bedingung oder Darstellung bezüglich der Beschreibung, Marktgängigkeit oder Zweckdienlichkeit dieser Geräte oder Bauteile dar.

Unabhängig von Beschreibung und Spezifikation(en) des hier beschriebenen Geräts behält sich Bibby Scientific Ltd das Recht vor, Änderungen an diesem Gerät oder dessen Bauteilen vorzunehmen.

INFORMACIÓN DE SEGURIDAD E INSTALACIÓN

SEGURIDAD DEL OPERARIO

Lea atentamente este manual antes de utilizar el ciclador térmico. Si el equipo no se utiliza de la forma descrita en este manual, se reducirá la protección ofrecida por el equipo.

Todos los instrumentos Bibby Scientific Ltd están diseñados para cumplir los requisitos internacionales de seguridad, e incluyen un dispositivo de corte de sobretensión. Si se produce un problema de seguridad, apague la unidad en la toma de alimentación y retire el enchufe del suministro eléctrico.

ADVERTENCIA

LAS ALTAS TEMPERATURAS SON PELIGROSAS, ya que pueden ocasionar quemaduras graves a los operarios y prender el material combustible. Los usuarios deben conocer los posibles riesgos:



- TENGA CUIDADO Y LLEVE GUANTES DE PROTECCIÓN PARA PROTEGERSE LAS MANOS
- NO utilice sustancias combustibles cerca de objetos calientes
- NO utilice el instrumento cerca de líquidos o gases inflamables
- NO coloque un líquido directamente en el instrumento. Utilice siempre los consumibles plásticos adecuados

Después de calentar las muestras, recuerde que hay componentes del instrumento que pueden calentarse mucho, concretamente la tapa y el cuerpo y todos los accesorios asociados.

DESEMBALAJE

Durante el desembalaje, asegúrese de sacar los siguientes componentes del embalaje:

- Ciclador térmico
- Cable de alimentación
- Tarjeta de garantía
- Certificado de descontaminación

Se recomienda guardar el embalaje original en caso de que tenga que enviar el instrumento para un trabajo de mantenimiento o reparación. Bibby Scientific Ltd no se responsabiliza de los daños producidos si la unidad no está debidamente embalada y no se envía en su embalaje original.

Tenga en cuenta que los objetos punzantes, p.ej.: bolígrafos, lápices y uñas, pueden dañar fácilmente la pantalla del ciclador térmico. Este tipo de daño se considerará como un uso incorrecto, e invalidará la garantía de este componente.

INSTALACIÓN

El instrumento se debe transportar con las dos manos. No mueva ni lleve el instrumento cuando se utilice o esté conectado al suministro eléctrico principal.

1. Todos los instrumentos Bibby Scientific Ltd se suministran con un cable de alimentación, que puede ser integrado o 'enchufable'.

2. El TC-3000G tiene una fuente conmutada que es conveniente para el uso con voltajes de entrada universales de CA entre 90 y 260V. Conecte el cable de alimentación a un enchufe adecuado según la siguiente tabla.

Conexión	220/240V, 50/60Hz Supply	110V/120V Supply, 50/60Hz
Con corriente	marrón	negro
Neutro	azul	blanco
Toma de tierra	verde/amarillo	verde

3. SÓLO PARA EL REINO UNIDO: El enchufe suministrado con el cable de alimentación incluye un fusible de 10 amperios para ofrecer protección al instrumento y al usuario.
4. Conecte el cable de alimentación en el enchufe situado en la parte trasera del instrumento.
5. Sitúe la unidad sobre una mesa plana o en una campana de laboratorio si es necesario, y asegúrese de que los orificios de ventilación situados en la parte inferior no tienen ninguna obstrucción. Coloque el instrumento a una distancia mínima de 200 mm alrededor de paredes u otros elementos, y entre cada unidad (en caso de que se utilicen varias) para que haya una circulación de aire adecuada para cada instrumento.
6. Encienda el instrumento:
- Interruptor de alimentación encendido
 - Interruptor de alimentación apagado

Cable de repuesto

Si es necesario sustituir el cable de alimentación, se debe utilizar un cable de 1mm² de código armonizado H05VV, conectado a un enchufe IEC320. **EN CASO DE DUDA, PÓNGASE EN CONTACTO CON UN ELECTRICISTA.**

CONDICIONES DE TRABAJO

El ciclador térmico está diseñado para utilizarse en las condiciones siguientes:

- Uso en interior
- Intervalo de temperatura ambiente +5°C a +40°C
- Humedad relativa no superior al 95%
- Fluctuaciones del suministro eléctrico no superiores al 10%
- Categoría de sobrevoltaje II IEC 60364-4-443
- Nivel de contaminación 2

Nota: Las especificaciones de control corresponden a una temperatura ambiental de 20°C. Las especificaciones pueden empeorar si se utiliza el instrumento fuera del intervalo de temperatura comprendido entre 10°C y 30°C.

Se han realizado pruebas para comprobar la interferencia de radiofrecuencia del instrumento, el cual cumple la normativa EN61326.

GARANTÍA

El instrumento está garantizado contra cualquier defecto en el material o la fabricación durante el período especificado en la tarjeta de garantía que se adjunta. Este período entra en vigor a partir de la fecha de compra. Durante este período, se reemplazarán sin cargo alguno todas las piezas defectuosas, a condición que el defecto sea resultado de un accidente, uso incorrecto o negligencia. Tenga en cuenta que los objetos punzantes, p.ej.: bolígrafos, lápices y uñas, pueden dañar fácilmente la pantalla del ciclador térmico. Este tipo de daño se considerará como un uso incorrecto, e invalidará la garantía de este componente.

El distribuidor del instrumento proporcionará información sobre las reparaciones realizadas bajo esta garantía.

Este manual se ha preparado con una finalidad informativa para los clientes de Bibby Scientific Ltd, y ninguna parte del manual se deberá considerar como una garantía, condición o reflejo con respecto a la descripción, comerciabilidad, idoneidad para un fin determinado o de otro tipo de la unidad o sus componentes.

Con independencia de la descripción y las especificaciones del instrumento que se indican en el manual del operario, Bibby Scientific Ltd se reserva el derecho de realizar cambios en el instrumento o en cualquiera de sus componentes cuando lo estime oportuno.

INFORMAZIONI SULLA SICUREZZA E L'INSTALLAZIONE

SICUREZZA DELL'OPERATORE

Leggere attentamente il presente manuale prima di usare il ciclatore termico. Se non si usa l'apparecchiatura nel modo descritto nel presente manuale, la protezione fornita dall'unità potrebbe risultarne diminuita.

Tutti gli strumenti Bibby Scientific Ltd sono progettati per rispettare i requisiti di sicurezza internazionali e sono montati con un sezionatore di sovratemperatura. In caso di problemi di sicurezza, spegnere l'unità dalla presa di rete centrale e togliere la spina dall'alimentazione elettrica.

AVVERTENZA

Le ALTE TEMPERATURE SONO PERICOLOSE in quanto possono provocare serie ustioni agli operatori e dare fuoco al materiale combustibile. Gli utenti devono conoscere i seguenti pericoli potenziali:



- PRESTARE ATTENZIONE ED INDOSSARE GUANTI PROTETTIVI PER LE MANI
- NON usare sostanze combustibili vicino ad oggetti caldi
- NON mettere in funzione lo strumento nei pressi di liquidi o gas infiammabili
- NON collocare alcun tipo di liquido direttamente nello strumento, usare sempre le parti di consumo in plastica idonee

Dopo aver riscaldato i campioni, ricordare che le parti dello strumento, cioè il coperchio ed il blocco ed eventuali accessori associati potrebbero essere molto caldi.

DISIMBALLAGGIO

Durante il disimballaggio, assicurarsi di aver tolto quanto segue dall'imballo:

- Ciclatore termico
- Cavo di alimentazione di rete
- Scheda di garanzia
- Certificato di decontaminazione

Si consiglia all'utente di conservare l'imballaggio originale nel caso in cui occorresse restituire lo strumento per assistenza o riparazioni. Se l'unità non è correttamente imballata e trasportata nel suo imballo originale, Bibby Scientific Ltd non accetta alcuna responsabilità per eventuali danni che dovessero verificarsi.

Notare come lo schermo del ciclatore termico si danneggia facilmente con oggetti appuntiti come penne, matite ed unghia. Questo tipo di danni sarà considerato come uso improprio e renderà nulla la garanzia per questo componente.

INSTALLAZIONE

Occorre trasportare lo strumento usando entrambe le mani. Non spostare né trasportare lo strumento quando è in funzione o collegato all'alimentazione elettrica di rete.

1. Tutti gli strumenti Bibby Scientific Ltd sono forniti con un cavo di alimentazione; può essere integrale o plugin.

2. Il modello TC-3000G dispone di alimentazione idonea per voltaggi in corrente alternata tra 90 e 260V. Collegare il cavo di alimentazione ad una spine idonea in accordo alla tabella sottoriportata.

Connessione	220/240V, Alimentazione 50/60Hz	Alimentazione 110V/120V, 50/60Hz
Sotto tensione	marrone	nero
Neutro	blu	bianco
Terra	verde/giallo	verde

3. SOLO REGNO UNITO: la spina con fusibile fornita con il cavo di rete è dotata di un fusibile da 10 Amp per proteggere lo strumento e l'utente.

4. Inserire il cavo di rete nella presa che si trova sul retro dello strumento.

5. Collocare l'unità su un banco piatto idoneo o in una cappa aspirante se necessario, assicurandosi che gli sfiati delle prese d'aria nella parte inferiore non siano ostruiti. Posizionare lo strumento con una distanza minima attorno di 200 mm. dalle pareti o da altri oggetti e tra ciascuna unità, nel caso in cui si usino unità multiple, in modo da consentire un flusso d'aria efficace per ciascuno strumento.

6. Accendere lo strumento:

- Interruttore di rete Acceso
- Interruttore di rete Spento

Cavo di ricambio

Qualora occorra sostituire il cavo di rete, si dovrà utilizzare un cavo di 1mm² codice armonizzato H05VV-F collegato ad una spina IEC 320. **IN CASO DI DUBBIO, RIVOLGERSI A UN ELETTRICISTA QUALIFICATO.**

CONDIZIONI DI ESERCIZIO

Il ciclatore termico è stato progettato per funzionare nelle seguenti condizioni:

- uso interno
- range di temperatura ambiente da +5°C a +40°C
- altitudine massima 2000 m.
- umidità relativa non superiore all'95%
- oscillazione dell'alimentazione di rete non superiore al 10%
- categoria di sovratensione II IEC 60364-4-443
- grado di inquinamento 2

Nota: le specifiche di controllo sono indicate ad una temperatura ambiente di 20°C. Le specifiche potrebbero peggiorare fuori da una temperatura ambiente compresa tra 10°C e 30°C.

Lo strumento è stato collaudato per interferenze da radiofrequenze ed è certificato secondo la norma EN61326.

GARANZIA

Lo strumento è garantito da qualsiasi difetto nei materiali o nella lavorazione per il periodo specificato nella scheda di garanzia allegata. Questo periodo è valido dalla data di acquisto; entro tale periodo, tutte le parti difettose saranno sostituite gratuitamente, a condizione che il difetto non sia la conseguenza di un incidente, un uso improprio o negligenza. Lo schermo del ciclatore termico può essere danneggiato da oggetti appuntiti come penne, matite ed unghia. Tale tipo di danno sarà considerato uso improprio e renderà nulla la garanzia per questo componente.

L'assistenza secondo quanto stabilito dalla presente garanzia deve essere ottenuta dal fornitore dello strumento.

Il presente manuale è stato preparato ad uso dei clienti di Bibby Scientific Ltd e niente di quanto in esso contenuto costituisce garanzia, condizione o rappresentanza riguardo la descrizione, la commerciabilità, l'idoneità allo scopo o altrimenti dell'unità o dei componenti.

Nonostante la descrizione e le specifiche dello strumento contenuti nel manuale dell'operatore, Bibby Scientific Ltd si riserva il diritto di apportare le modifiche ritenute opportune agli strumenti o a qualsiasi loro componente.

BEFORE SWITCHING ON

TC-3000G

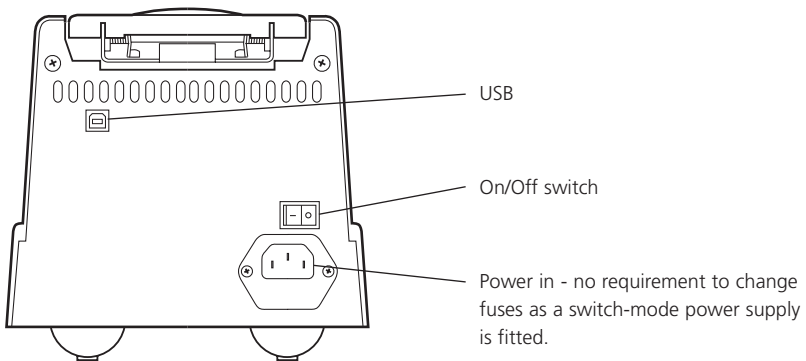

CONTACT INFORMATION

For technical, sales or servicing information, contact your local Bibby Scientific Ltd dealer or:

UK and Rest of World

Bibby Scientific Ltd
Beacon Road, Stone
Staffordshire ST15 0SA, UK
Tel: +44 (0)1785 812121
Fax: +44 (0)1785 813748
e-mail: techne@bibby-scientific.com
www.bibby-scientific.com

France

Bibby Scientific France SAS
ZI du Rocher Vert - BP 79
77793 Nemours Cedex
France
Tel: +33 1 64 45 13 13
Fax: +33 1 64 45 13 00
e-mail: bsf@bibby-scientific.fr
www.bibby-scientific.com

Middle East

Techne Middle East Ltd.
PO Box 27887, Engomi 2433
Nicosia
Cyprus
Tel: +357 22 660427
Fax: +357 22 660356
e-mail: sales@techneme.com

North and South America

Techne Inc.
3 Terri Lane, Suite 10
Burlington, N.J. 08016, USA
Tel: 800-225-9243
Fax: 609-589-2571
e-mail: labproducts@techneusa.com
www.techneusa.com

Italy

Bibby Scientific Italia Srl
Via Alcide de Gasperi 56
20077 Riozzo di Cerro al Lambro
Milano, Italia
Tel: +39 (0)2 98230679
Fax: +39 (0)2 98230211
e-mail: marketing@bibby-scientific.it
www.bibby-scientific.it

Far East

Bibby Scientific (Asia) Ltd
Room 607 Yen Sheng Centre
64 Hoi Yuen Road Kwun Tong
Kowloon Hong Kong
Tel: +852 3583 1581
Fax: +852 3583 1580
e-mail bibby@bibby-scientificasia.com
www.bibby-scientificasia.com

TC-3000G SPECIFICATION

Temperature

Gradient range	20°C to 80°C
Maximum gradient	15°C
Minimum gradient	1°C
Temperature range	4°C to 99°C
Temperature set point precision	0.1°C
Block uniformity (over full range)	± 0.2°C
Temperature accuracy	± 0.2°C
Pre-run sample cooling	Yes
End of program cooling below ambient	Yes

Heating/Cooling Rate

Heating rate, between 55°C and 90°C on a 50°C to 95°C step:	
0.2 ml micro tubes	3.3°C/sec
0.5 ml micro tubes	3.3°C/sec
Cooling rate, between 90°C and 55°C on a 95°C to 50°C step:	
0.2 ml micro tubes	2.0°C/sec
0.5 ml micro tubes	2.0°C/sec

Heated Lid

Adjustable heated lid	Yes
Heated lid enable/disable	Yes
Selectable heated lid temperature	100°C to 115°C
Over-temperature cut-out	Fixed at 145°C
Temperature sensor	Thermistor
Heater type	Etched foil
Heater power	33W
Warm up time	4 min approximately (ambient to 105°C)

The heated lid will only come on
if the set temperature is above 35°C

Programming

Program naming using alpha keys	Yes
Program password protection	Yes
Number of programs (3 step)	80
Maximum number of steps per stage	35
Maximum number of stages per program	25
Minimum hold time	1 sec
Maximum hold time	18 hrs
Incremental/decremental temperature	Yes
Incremental/decremental step hold time	Yes
Programmable ramp rate (heat or cool)	Variable in 0.1°C/sec steps
Programmable ramp rate resolution	0.1°C

Running Programs

Pause button	Yes
Stop button	Yes
End of program alarm	Yes
Auto restart on power fail	Yes

Interconnectivity

Connection to PC control program	Yes
Software updates from Bibby Scientific Ltd web-site	Yes

Dimensions

Height	185mm
Width	185mm
Length	335mm

Communication Ports

PC connection to run "Gensoft" the PC control software.	USB
---------------------------------------------------------	-----

Power

Power consumption	230W
-------------------	------

The TC-3000G unit is supplied with a switched mode power supplier so the unit automatically recognises the input voltage.

USER OPERATION AND CONSUMABLES

HEATED LID

The heated lid has a rotating knob to adjust the lid pressure on the samples, allowing for a variety of consumables to be used. To adjust the pressure:

- Adjust the orange rotating knob anticlockwise to give the least pressure.
- Place the samples in the block and place the lid in the down position.
- Gently rotate the knob clockwise until you can feel pressure beginning to be applied.
- Rotate the knob a further quarter of a turn and this will give the correct pressure.

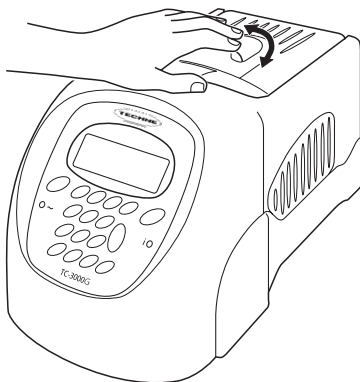

Do not over-tighten the knob as this will cause deformation of the silicone rubber mat (where used) and reduce the effectiveness of the lid. Once the pressure has been set it does not need to be adjusted unless a different block or consumable is used.

The silicone rubber mat supplied with the unit (Part number 6106196) is for use with 48 well microplates when sealing using a plastic adhesive film. The mat should be placed on top of the sealing film to ensure good thermal contact with the heated lid.

TUBES OR REACTION VESSELS

Bibby Scientific Ltd does not recommend any specific tube or reaction vessel other than those described in this manual. We recommend using reaction volumes between 20 and 200 μ l. The tubes must withstand a pressure of 1 atmosphere at 100°C. Any vessel must be able to withstand the temperatures you are using without any danger of them deforming to the point where they fracture.

To test your tubes, put 25 μ l of water into each of 5 tubes and subject them to a typical thermal cycling protocol. At the end of the program, measure the volume remaining using a micropipette. A loss of more than 1 or 2 μ l indicates a vapour leak.

The amount of volume loss you observe and the change in reactant concentrations you can tolerate determine the minimum volume that can be used. Typical volume losses of 1 μ l in 30 cycles allow the use of samples of 20 μ l or less.

During the final cool-down, a ring of condensation may form above the liquid level but below the top of the sample block. This is normal and does not effect the reaction.

0.5ML TUBES

In order to fit the maximum number of tubes in the block, they need to be placed so that all the hinges are in the same relative orientation. An example is illustrated below.

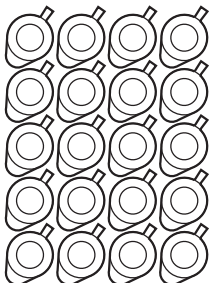

Place the tubes in the block in the same orientation in order to achieve the maximum capacity.

Always make sure the pressure on the heated lid is balanced by spreading the tubes across the block or inserting some dummy tubes if necessary.

PLATES AND SEALS

The 48 x 0.2ml block of the TC-3000G will accept 48-well plates as well as individual and strip 0.2ml tubes. To avoid the possibility of sample evaporation Bibby Scientific Ltd recommends that plates are sealed with appropriate caps or heat seals. We do not recommend the use of adhesive seals, but if their use is unavoidable then the supplied silicone rubber mat should be placed on top of the sealing film to ensure good thermal contact with the heated lid.

SWITCHING ON

```
TC-3000G
Version      x.xx
Block       48x0.2ml GRAD
```

When you switch on the unit a screen similar to the one shown here will appear briefly. This indicates the software version and block type installed in the unit.

```
Programs [0]
Information
Configuration
Gradient calculator
[ ↑ ↓ , ← to select ]
```

When the initial screen has disappeared the screen shown here will automatically appear. There are four options:

1. 'Programs' for creating and running programs;
2. 'Information' for obtaining information about the unit e.g. serial number;
3. 'Configuration' for setting up program defaults and settings.
4. Gradient calculator for displaying column temperatures of a set gradient.

Each of these is explained in detail in the following sections.

FRONT PANEL CONTROLS

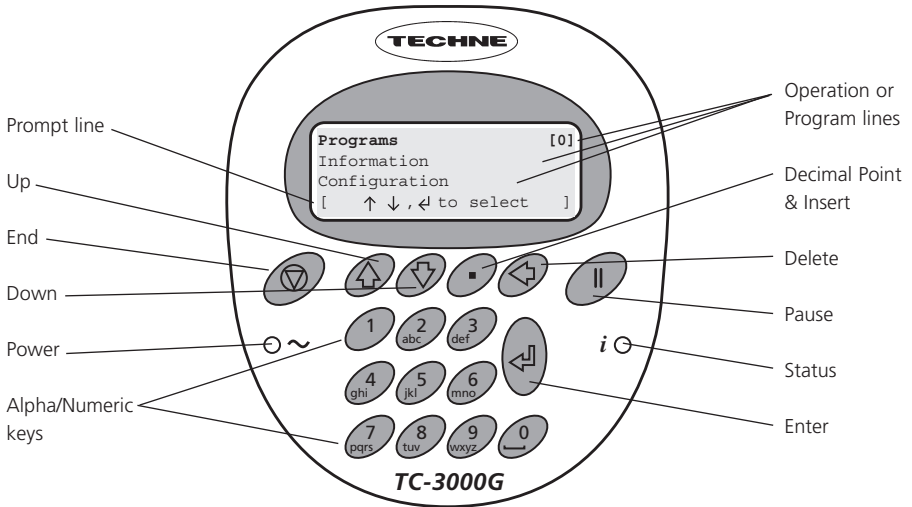

THE LCD DISPLAY

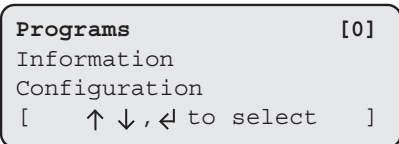

The TC-3000G has a four line LCD display. The top three lines are information or program lines, while the bottom line is a prompt line. The active line flashes on screen and is shown in bold in this manual.

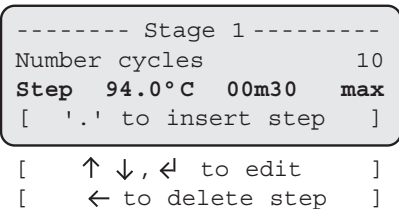

The bottom line may change or flash between two or three different prompts depending upon which program line is active. An example of a prompt line which flashes between three different prompts is shown here.

INDICATORS

○ ~ Power: This indicator is lit when there is power to the TC-3000G.

i ○ Status: This indicator is lit when the unit is running a program. It is off when the unit is stopped. It will flash and beep slowly when the unit is paused. It will flash after a five second quick sequence of beeps when the unit reaches its final hold temperature.

THE KEYS

The End, Finish or Exit key



The "End" or "Finish" key is used to finish editing programs or to exit a program. It is also used to exit a sequence of key operations.

The Up arrow key



The "Up arrow" key is used for scrolling up through the lines on the screen. It is also used to increase certain fields when editing.

The Down arrow key



The "Down arrow" key is used for scrolling down through the lines on the screen. It is also used to decrease certain fields when editing.

The Decimal Point and Insert key



The "Decimal Point" key is used when editing numeric fields. It is also used as an Insert key during program editing to insert additional steps and other field sets.

The Delete key



The "Delete" key is used during program editing to delete steps and stages.

The Pause key



The "Pause" key is used during program editing to insert a pause after a stage, to insert increment and decrement times and temperatures and to set a gradient across the block. It is also used to pause a program when it is running.

The Enter or Accept key



The "Enter" key is used to enter an operation or the edit mode. It is also used to 'Accept' a field or program change.



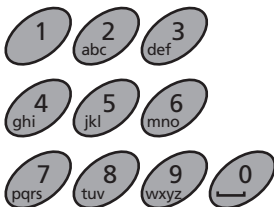







The Alpha/Numeric keys



The "Alpha/Numeric" keys are used to enter numbers and letters during programming. If it is a numeric field then numbers will be inserted; if it is an alpha field then letters will be inserted. Each key will cycle through the letters shown on the key (0 will insert a space). To insert a number, press and hold the appropriate key.

PROGRAMMING THE TC-3000G

The table below illustrates the symbols which appear on the LCD display and the relevant keypad button to which they refer.

	In the prompt line is equivalent to the "End" key.	
	On a program line means the program is locked; it can be copied and then edited but not edited directly.	
	Up arrow	
	Down arrow	
	Enter	
	Pause	

The following terms are used when programming the thermal cyclers:

- Stage** A 'Stage' is the name given to the main repeated part of a program containing the 'Steps' to be repeated. A program can contain a maximum of 25 stages although typically only one or two are used.
- Cycle** A 'Cycle' is the number of repetitions of a 'Stage'
- Step** A 'Step' is a user defined program line containing a temperature, a hold time and ramp rate. Typically three steps are created within one 'Stage'.

```

Programs [0]
Information
Configuration
[   ↑ ↓ , ← to select ]
    
```

To enter the **programming** section of the software, highlight 'Programs' using the "Up Arrow" or "Down Arrow" keys ↑ ↓
Press "Enter" ←

```

* * New Program * * [ ]
2 STEP TEMPLATE 501  ⏏
3 STEP TEMPLATE 502  ⏏
[   ↑ ↓ , ← to select ]
    
```

This screen lists all the programs saved on the unit. Use the "Up Arrow" and "Down Arrow" keys to scroll through the list. ↑ ↓

The number next to the program name is the unique "Speed dial" number allocated to the program for rapid retrieval (see below).

PROGRAMMING OPTIONS

There are two options available for creating programs on the TC-3000G:

1. Copy and edit one of the pre-written templates.
2. Create a new program from the defaults.

OPTION 1: CREATING PROGRAMS USING TEMPLATES

There are two pre-written basic PCR templates: a two-step and a three-step template. These can be copied and modified as required.

```

2 STEP TEMPLATE
Heated Lid          105°C
Preheat Lid         on
Sample cooling       on
Pause               off
-----
In denat            94°C 5m00
Hot Start           off
----- Stage 1 -----
Number cycles       30
Step 94.0°C 0m30 max
Step 68.0°C 1m00 max
-----
Final Extn 72.0°C 5m00
Final hold          10.0°C
    
```

```

3 STEP TEMPLATE
Heated Lid          105°C
Preheat Lid         on
Sample cooling       on
Pause               off
-----
In denat            94.0°C 5m00
Hot Start           off
----- Stage 1 -----
Number cycles       30
Step 94.0°C 0m30 max
Step 55.0°C 0m30 max
Step 72.0°C 0m30 max
-----
Final Extn 72.0°C 5m00
Final hold          10.0°C
    
```

Other templates available include Ice bucket (incubation at 4°C), Ligation (incubation at 15°C) and an RT-PCR template.

```

* * * New Program * * *
2 STEP TEMPLATE 501  [F]
3 STEP TEMPLATE 502  [F]
[  ↑ ↓, ← to select  ]
    
```

Use the "Down Arrow" key ↓ to select an existing 'Template' program from the menu, e.g. '2 Step Template' or '3 Step Template'.

Press the "Enter" key ↵ to accept it.

```

2 STEP TEMPLATE [501]
Run program
View program
[  ↑ ↓, ← to select  ]
    
```

The Template is already defined and can be run as it is or easily copied, modified and saved under a new name.

```

Run program
View program
Copy program
[  ↑ ↓, ← to select  ]
    
```

Use the "Down Arrow" key ↓ to select 'Copy Program' Press the "Enter" key ↵ to accept it.

```

UNNAMED #
Heated Lid      105°C
Preheat Lid     on
[   ↑ ↓ , ← to edit   ]
    
```

A new name can now be given to the copied program (see below).

To give a program a name

```

█ UNNAMED #
Heated Lid      105°C
Preheat Lid     on
[   ↑ ↓ , ← to edit   ]
    
```

To type in a name for the program, press "Enter" ← and a cursor will appear in the position shown.

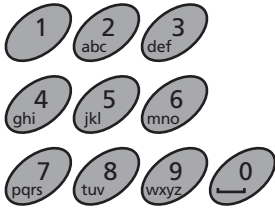

Using the keypad, type in the name you wish to give the program.

The letters will scroll round with successive presses; for example the "2" key will give 'A' with one press; 'B' with two presses; 'C' with three presses and '2' with four presses. Five presses will again give 'A'.

When the name is complete, press "Enter" ←

```

DONNA
Heated Lid      105°C
Preheat Lid     on
[   ↑ ↓ , ← to edit   ]

[   ▽ to save   ]
    
```

There are now two options:

1. Save the program and run it as it is or
2. Edit the program then save and run it.

To save the program

```

DONNA
Heated Lid      105°C
Preheat Lid     on
[   SAVE?   ]

[   ← YES or ▽ NO   ]
    
```

A program can only be run once it has been saved. Press the "End" ▽ key.

The prompt line will flash between 'SAVE?' and 'YES or NO'.

Press "Enter" ← for 'Yes' to save the changes you have made.

If you press "End" ▽ for 'No' then all the changes you have made will be lost.

```

DONNA [7]
Run Program
View Program
[   ↑ ↓ , ← to select   ]
    
```

The program is now ready to run and will be allocated with a unique 'Speed dial' number which can be used to rapidly locate the program from the main start-up screen.

The "Up Arrow" or "Down Arrow" keys ↑ ↓ can be used to scroll through the remaining list of options.

To edit a field or step in an existing program

```

Programs [0]
Information
Configuration
[ ↑ ↓ , ← to select ]
    
```

```

DAVID 8 [D]
DONNA 7
[ ↑ ↓ , ← to select ]
    
```

```

DONNA [7]
Run program
View program
Edit program
Copy program
Delete program
Set password
[ ↑ ↓ , ← to select ]
    
```

Edit a selected field or step

```

DONNA
Heated Lid 105°C
Preheat Lid on
[ ↑ ↓ , ← to edit ]
    
```

```

[ ▽ to save ]
    
```

When the unit is switched on the display will show this screen.

If known, type in the 'Speed dial' number for the required program and press "Enter" ← This will take you directly to the required program.

If you do not know the 'Speed dial' number, press "Enter" ← to access the list of stored programs.

Either:

1. Scroll to the required program using the "Up Arrow" or "Down Arrow" keys ↑ ↓ or
2. Type the first letter of the program name in the 'New program' field; this will then list all the program names beginning with that letter. Use the "Up Arrow" or "Down Arrow" keys ↑ ↓ to select the required program.

Press "Enter" to accept ←

The full set of options for a program is shown here; these are shown on the LCD screen three lines at a time.

Use the "Down Arrow" and/or the "Up Arrow" keys ↑ ↓ to select the option you require.

Press the "Enter" key ← to select the option.

Select 'Edit program' and a screen similar to this will appear.

Use the "Down arrow" and/or the "Up arrow" keys ↑ ↓ to select the field or step you want to edit.

You can now edit the active field or step by first pressing the "Enter" key ←

```

DONNA
Heated Lid      █ 105°C
Preheat lid      on
[ edit temperature ]

[ ← to disable ]
    
```

```

DONNA
Heated Lid      105°C
Preheat lid      █ on
[ ↑ ↓ to change ]

[ turn on/off ]
    
```

```

DONNA
Preheat Lid      █ on
Sample cooling    off
    
```

```

Pause           off
-----
In denat  █ 4.0°C  00m30
[ edit temperature ]

[ ← to disable ]
    
```

```

Pause           off
-----
In denat  94.0°C  █ 00m30
[ edit time ]

[ .for hrs/mins ]
    
```

```

-----
Fin extn 72.0°C      5m00
Fin hold  10.0°C
[ ↑ ↓, ← to edit ]

[ ▽ to save ]
    
```

To edit a temperature, type in the required temperature. In the example here, the heated lid temperature is being edited.

Press "Enter" \leftarrow to accept.

Use the "Down Arrow" and/or the "Up Arrow" keys \uparrow \downarrow to select the next field or step you wish to edit.

To edit a field with on/off settings, first select the field and press "Enter" \leftarrow

Use the "Up Arrow" and "Down Arrow" keys to toggle \uparrow \downarrow between the settings.

Press "Enter" \leftarrow to accept.

Sample cooling enables the block to be actively cooled to 4°C whilst the heated lid is reaching the correct temperature.

To edit a step with both a temperature and a time, first press "Enter" \leftarrow and type in the new temperature. Press "Enter" \leftarrow again. Now type in the new time. The default is minutes.

1. For whole minutes, type the number required then "Enter" \leftarrow .
2. To toggle between minutes and hours, use the "Decimal Point" key.
3. For values less than 1 minute, first press the "Decimal Point" key followed by the number of seconds required.
4. For minutes and seconds, type the number of minutes followed by the "Decimal Point" key then the number of seconds.

Once the values have been added, press "Enter" \leftarrow to accept.

Once you have finished editing and you are happy with the changes, press the "End" key ∇ followed by the "Enter" key \leftarrow to save.

If you press the "End" key ∇ a second time for 'No' then all the changes you have made will be lost.

To copy a selected program

```

UNNAMED #
Heated Lid      105°C
Preheat Lid     on
[   ↑ ↓ , ← to edit   ]
[   ▽ to save         ]

```

To delete a selected program

```

DONNA
delete program
SURE?
[   ← Yes or ▽ No     ]

```

To set a password for a selected program

```

DONNA
New passwd █
[   ← to accept       ]
[   ▽ to exit         ]

```

OPTION 2: CREATING A NEW PROGRAM

A second option is to create a completely new program without using templates.

```

UNNAMED #
Heated Lid      105°C
Preheat Lid     on
Sample cooling   on
Pause           off
-----
In denat       94.0°C   5m00
Hot Start      off
-----
Final extn     72.0°C   5m00
Final hold     10.0°C

```

If you select 'Copy program' a screen similar to this will appear and the software will automatically give the program the next number until it is named.

Press "Enter" \leftarrow and type in a new name. You will then be able to edit the program as previously described.

If you select 'Delete program' a screen similar to this will appear.

Press "Enter" \leftarrow to delete the program or "End" ∇ to return to the program screen.

If you want to password protect the program so that other users cannot edit it, select 'Set password'. A screen similar to this will appear. Type in the password you wish to give it and press "Enter" \leftarrow . The program list will then display the key symbol \boxplus next to the name to show that it is locked. Other users will still be able to copy/view your program but not edit it.

A number of typical values are pre-entered including:

Heated lid temperature
Preheat lid
Sample cooling
Initial denaturation
Hot start
Final extension
Final hold

These values can be edited and the additional stages and steps required for cycling can be added by following the instructions detailed on the following pages.

EXAMPLE PROGRAMS

A couple of example thermal cycling programs are shown below.

Typical 3-Step PCR

```

Heated Lid          105°C
Preheat Lid         on
Sample cooling       on
Pause              off
-----
In denat  94.0°C    5m00
Hot Start          off
----- Stage 1 -----
Number cycles          30
Step  94.0°C  0m30  max
Step  55.0°C  0m30  max
Step  72.0°C  0m30  max
-----
Final Extn  72.0°C    5m00
Final hold   10.0°C
  
```

3-Step PCR with multiple 'Stages'

```

Heated Lid          105°C
Preheat Lid         on
Sample cooling       on
Pause              off
-----
In denat  94.0°C    5m00
Hot Start          off
----- Stage 1 -----
Number cycles          10
Step  94.0°C  0m30  max
Step  60.0°C  0m30  max
Step  72.0°C  0m30  max
----- Stage 2 -----
Number cycles          20
Step  94.0°C  0m30  max
Step  55.0°C  0m30  max
Step  72.0°C  0m30  max
-----
Final Extn  72.0°C    5m00
Final hold   10.0°C
  
```

PROGRAMMING

```

* * New Program * * [ ]
2 STEP TEMPLATE  501  ↓
3 STEP TEMPLATE  502  ↓
[   ↑ ↓ , ← to select ]
  
```

```

UNNAMED #
Heated Lid          105°C
Preheat Lid         on
[   ↑ ↓ , ← to edit ]
[   ▽ to save ]
  
```

To add a stage and then edit it

```

In denat  94.0°C    5m00
Hot Start          off
-----
[   ← to insert stage ]
  
```

Create a new program by selecting ** New Program ** from the menu and press "Enter" ←

Give the program a name and edit any of the default fields as described above.

Use the "Down Arrow" ↓ key to scroll to the dotted line below 'Hot Start'; it will start to flash.

Press "Enter" ← to insert a stage.

```

----- Stage 1 -----
Number cycles          █
Step  94.0°C 00m30  max
[  ← edit no.cycles  ]
    
```

A new stage will be inserted which consists of a 'Number cycles' field and one step.

Edit the number of cycles by typing the number required then press "Enter" ↵

```

----- Stage 1 -----
Number cycles          10
Step  94.0°C 00m30  max
[  '.' to insert step  ]
[  ↑ ↓, ← to edit    ]
[  ← to delete step  ]
    
```

Use the "Down Arrow" ↓ key to move to the step.

Press "Enter" ↵ to edit the step as described above.

Press "Enter" ↵ again to accept.

To insert additional steps

```

----- Stage 1 -----
Number cycles          10
Step  94.0°C 00m30  max
[  '.' to insert step  ]
[  ↑ ↓, ← to edit    ]
    
```

To insert a new step before the first step, use the "Up Arrow" or "Down Arrow" ↑ ↓ keys to select 'Number cycles'.

Press the "Decimal Point" key to insert a new step.

To insert a new step after an existing step, use the "Up Arrow" or "Down Arrow" ↑ ↓ keys to select the step.

Press the "Decimal Point" key to insert a new step.

To delete a step

```

----- Stage 1 -----
Number cycles          10
Step  94.0°C 00m30  max
[  '.' to insert step  ]
[  ↑ ↓, ← to edit    ]
[  ← to delete step  ]
    
```

Use the "Up Arrow" or "Down Arrow" ↑ ↓ keys to select the step you wish to delete.

Press "Delete" ← to delete the step.

```

----- Stage 1 -----
Number cycles          10
Step  94.0°C 00m30  max
[  DEL STEP ?        ]
[  ← Yes or ▽ No    ]
    
```

The prompt line will flash between 'DEL STEP?' and 'YES or NO'.

Press "Enter" ↵ to delete the step.

or

Press "End" ▽ to return to editing the step.

To add a new stage before an existing one

```

----- Stage 1 -----
Number cycles      10
Step  94.0°C  00m30  max
[   ↵ to insert stage ]

[   ← to delete stage ]

```

Use the "Up Arrow" or "Down Arrow" ↑ ↓ keys to highlight the stage number.

Press "Enter" ↵

A new stage will be added before the existing stage. The other stage numbers will be adjusted as appropriate. The new stage can now be edited as described above.

To add a new stage at the end

```

-----
Final Extn 72.0°C   5m00
Final hold           10.0°C
[   ↵ to insert stage ]

```

Use the "Up Arrow" or "Down Arrow" ↑ ↓ keys to highlight the dotted line below the last stage.

Press "Enter" ↵

A new stage will be added with the next consecutive number. The new stage can now be edited as described above.

To delete a stage

```

----- Stage 1 -----
Number cycles      10
Step  94.0°C  00m30  max
[   ↵ to insert stage ]

[   ← to delete stage ]

```

Use the "Up Arrow" or "Down Arrow" ↑ ↓ keys to highlight the stage you wish to delete.

Press "Delete" ←

```

----- Stage 1 -----
Number cycles      10
Step  94.0°C  00m30  max
[   DEL STAGE?   ]

[   ↵ Yes or ▽ No ]

```

The prompt line will flash between 'DEL STAGE?' and 'YES' or 'NO'.

Press "Enter" ↵ to delete the stage.

To insert a 'pause' into a program

```

Step 94.0°C 00m30 max
----- Stage 2 -----
Number cycles █
Step 94.0°C 00m30 max
[ '.' to insert step ]
[ ↑ ↓ , ← to edit ]
    
```

```

Step 94.0°C 00m30 max
----- Stage 2 -----
Number cycles 0
Step 94.0°C 00m30 max
[ CHANGE TO PAUSE ]
[ ← Yes or ▽ No ]
    
```

```

----- Stage 2 -----
Pause
-----
[ ← to insert step ]
[ ← to delete step ]
    
```

To insert a pause after an existing stage, follow the steps for inserting a stage as above.

Highlight the 'Number cycles' line then press "Pause" | |

The prompt line will flash between 'CHANGE TO PAUSE?' and 'YES or NO'.

Press "Enter" ← to insert a pause.

The stage number will then be highlighted with 'Pause' as the only line.

TO PROGRAM A GRADIENT

A gradient of temperatures across the block can be useful in optimising the annealing conditions for primers; a gradient can be set around a temperature in any step of a program. The set temperature is the temperature required in the middle columns of the block and the gradient is the variation at the two extremes of the block; the left hand columns being the coolest and the right hand columns the hottest.

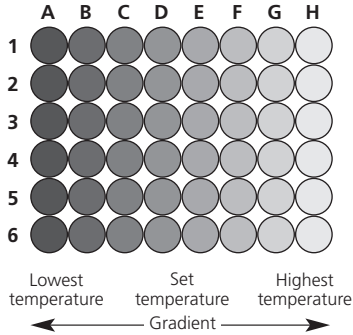

The maximum temperature gradient which can be set in the TC-3000G is 15°C; the lowest temperature is 20°C and the hottest temperature is 80°C. The minimum gradient is 1°C. Examples are given in the table below:

Lowest temperature (°C)	Set temperature (°C)	Highest temperature (°C)	Gradient (°C)
20.0	27.5	35.0	15
52.5	60.0	67.5	15
70.0	75.0	80.0	10
52.5	55.0	57.5	5
59.5	60.0	60.5	1

It is important to remember that the greater the gradient, the poorer the uniformity across the block, therefore fine-tuning may be required to establish the optimum temperature. While the gradient is mainly linear there are small variations at the extremes of the gradient due to a loss of heat from the hottest part of the block and a gain of heat from the adjacent column on the coldest. This is the reason why the first column does not reach the lowest ideal temperature of the gradient and the last column cannot reach the highest temperature.

A gradient calculator is included in the software which can be used to display more accurately the temperatures of the block for any given gradient. The gradient calculator is located in the menu on the first screen of the cyclor software (see also the section GRADIENT CALCULATOR).

```

Number cycles      30
Step  94.0°C  00m30  max
Step  58.0°C  00m30  max
[  ↑ ↓ , ← to edit  ]

[  ← to delete step  ]
[  '.' to insert step ]
    
```

Use the "Up Arrow" or "Down Arrow" ↑ ↓ keys to move to the step where you want to program a gradient.

Press "Enter"↵ to go into edit mode.

Press "Pause" | |

```

Number cycles      30
Step  94.0°C  00m30  max
Step  58.0°C  00m30  max
[  CHANGE STEP ?  ]

[  ← Yes or ▽ No  ]
    
```

The prompt line will change to flash between 'CHANGE STEP?' and 'YES' or 'NO'.

Press "Enter" ↵

Now press the "Up Arrow" key ↑

```

Number cycles      30
Step  94.0°C  00m30  max
grad  58.0°C  00m30  max
[  ↑ ↓ , ← to edit  ]
    
```

Using the "Up Arrow" key ↑ the line will toggle between grad, fst (for increment/decrement) and step. Select grad meaning "gradient".

Press "Enter" ↵ twice to go into edit mode.

```

Number cycles      30
Step  94.0°C  00m30  max
grad  58.0°C  00m30  max
[  edit temperature ]
    
```

Use the "Alpha/numeric" keys to change the values of the grad line to the set temperatures and/or times you require.

Press "Enter" ↵ after each field you change. You will exit 'Edit Mode' when you reach the end of the line.

```

Step  94.0°C  00m30  max
Step  58.0°C  00m30  max
gradient      5.0°C
[  edit temperature ]
    
```

Use the "Down Arrow" key ↓ to move onto the 'gradient' line.

Press "Enter" ↵ to edit the gradient range. A gradient range between 1 and 15°C can be entered.

Press "Enter" ↵ to accept.

```

Step  94.0°C  00m30  max
Step  75.0°C  00m30  max
gradient      15.0°C
[  edit temperature ]
    
```

If the step temperature is edited such that, for the currently entered gradient range, the unit will be forced outside the gradient limits, the gradient range will be reduced so as to preserve the set temperature.

```
Step 94.0°C 00m30 max
Step 75.0°C 00m30 max
gradient 10.0°C
[ gradient reduced ]
```

A warning prompt will be given on the screen.

```
Step 94.0°C 00m30 max
Step 75.0°C 00m30 max
gradient 15.0°C
[ edit temperature ]
```

If the gradient range is edited such that, for the currently entered step temperature, the unit will be forced outside the gradient limits, the step temperature will be reduced so as to preserve the gradient range.

```
Step 94.0°C 00m30 max
Step 72.5°C 00m30 max
gradient 15.0°C
[ temp reduced ]
```

A warning prompt will be given on the screen showing whether the temperature has been reduced or increased.

```
Cycle 7/30 56m08
Sample 55.5°C → 60.5°C
Hold @ 58.0°C 00m17
[ ▽ to STOP ]
```

When the program is running, the screen will indicate the temperature range of the columns in the gradient step.

```
[ || to pause ]
[ ↵ for info ]
```

TO PROGRAM INCREMENT OR DECREMENT TEMPERATURE OR TIME

Under normal circumstances, the Hold Temperature of all steps is constant. However, it is possible to automatically increment or decrement the temperature of a specified step of a programme.

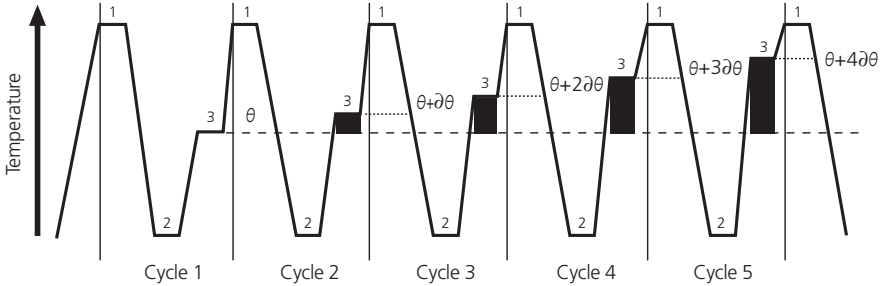

Temperature profile of incremented Hold Temperature at step 3 of each cycle

The Hold Temperature of the incremented/decremented step is the defined Hold Temperature plus the summation of the increments/decrements. The first cycle is never incremented/decremented, only subsequent cycles. If you select a decrement, the Hold Temperature is prevented from falling below 4°C. If you select an increment, the Hold Temperature is prevented from rising above 99°C.

Similarly, under normal circumstances, the Hold Time of all steps is constant. However, it is possible to automatically increment or decrement the duration of a specified step of a program.

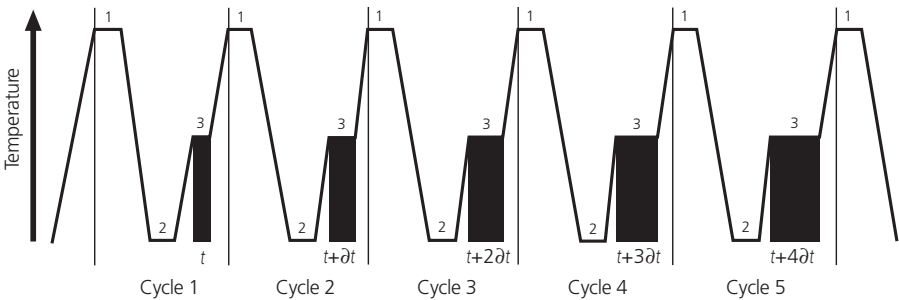

Temperature profile of incremented Hold Time at step 3 of each cycle

The Hold Time of the incremented/decremented step is the defined Hold Time plus the summation of the increments/decrements. The first cycle is never incremented/decremented, only subsequent cycles. If you select a decrement, the Hold Time is prevented from falling below one second.

```

Number cycles          30
Step  94.0°C  00m30  max
Step  58.0°C  00m30  max
[      , to edit      ]

[ ← to delete step   ]
[ \.' to insert step ]
    
```

```

Number cycles          30
Step  94.0°C  00m30  max
Step  58.0°C  00m30  max
[ CHANGE STEP ?      ]

[ ← Yes or ▽ No     ]
    
```

```

Number cycles          30
Step  94.0°C  00m30  max
fst  55.0°C  00m30  max
[ ↑ ↓, ← to edit    ]

[ ▽ to save         ]
    
```

```

Number cycles          30
Step  94.0°C  00m30  max
fst █  65°C  00m30  max
[ edit temperature   ]
    
```

```

Step  94.0°C  00m30  max
fst   65.0°C  00m30  max
lst   55.0°C  00m30
[ ↑ ↓, ← to edit    ]

[ ← to delete step   ]
[ \.' to insert step ]
    
```

Use the "Up Arrow" or "Down" Arrow" ↑ ↓ keys to move to the step where you want an increment or decrement temperature or time

Press "Enter" ← to go into edit mode.

Press "Pause" | |

The prompt line will change to flash between 'CHANGE STEP?' and 'YES' or 'NO'.

Press "Enter" ←

Now press the "Up Arrow" key ↑

Using the "Up Arrow" key ↑ the line will toggle between grad, fst and step. Select "fst" meaning "first".

Press "Enter" ← twice to go into edit mode.

Use the "Alpha/numeric" keys to change the values of the 'fst' line to the first temperatures and/or times you require.

Press "Enter" ← after each field you change.

You will exit 'Edit Mode' when you reach the end of the line.

Use the "Down Arrow" key ↓ to move onto the "lst" line, meaning "last".

Press "Enter" ← to edit the step.

```

Step  94.0°C  00m30  max
fst   65.0°C  00m30  max
lst  55.0°C  1m30
[      edit time      ]

[      .For hrs/mins  ]
    
```

Use the "Alpha/numeric" keys to change the values of the 'lst' line to the final temperatures and/or times you require.

Press "Enter" \leftarrow for each field you change.

You will exit 'Edit Mode' when you reach the end of the line.

When you run the program it will automatically increment or decrement in equal steps from the first time and/or temperature to the last over the number of cycles in the stage. For example: if the first temperature is 65°C and the last temperature is 55°C, over 30 cycles the temperature will decrease 0.33°C each cycle. Similarly, in the example shown, the time would increase from 30 seconds to 1 minute 30 seconds in 2 second increments.

To save the program

```

----- Stage 1 -----
Number cycles           10
Step  94.0°C  00m30  max
[      SAVE?          ]

[      ↵ Yes or ▽ No  ]
    
```

A program can only be run once it has been saved. Press the "End" ∇ key.

The prompt line will flash between 'SAVE?' and 'YES or NO'.

Press "Enter" \leftarrow for 'Yes' to save the changes you have made.

If you press "End" ∇ for 'No' then all the changes you have made will be lost.

```

                GEORGE      (10)
Run Program
View Program
[      ↑ ↓ , ↵ to select  ]
    
```

The program is now ready to run and will be allocated with a unique "Speed dial" number which can be used to rapidly locate the program from the main start-up screen.

Use the "Up Arrow" and "Down Arrow" $\uparrow \downarrow$ keys to scroll through the list of options.

Stopping what you are doing

At any time during programming the TC-3000G, when you are satisfied with the program, you can finish and accept what you have done by first pressing the "End" ∇ key, then follow the instructions on screen. If you are not sure, wait for the instructions in the prompt line to scroll back to the first line that you see.

TO RUN A PROGRAM

```

Programs [0]
Information
Configuration
[ ↑ ↓ , ← to select ]

```

```

Programs [7]
Information
Configuration
[ ↑ ↓ , ← to select ]

```

```

* * New Program * * [ ]
2 STEP TEMPLATE 501 9
3 STEP TEMPLATE 502 9
[ ↑ ↓ , ← to select ]

```

```

DAVID 8 [D]
DONNA 7
[ ↑ ↓ , ← to select ]

```

```

DONNA [7]
Run Program
View Program
[ ↑ ↓ , ← to select ]

```

```

DONNA
[ RUN PROGRAM? ]
[ ← Yes or ▽ No ]

```

When the unit is switched on the display will show this screen.

If known, type in the 'Speed dial' number for the required program and press "Enter" ←. This will take you directly to the required program.

If you do not know the 'Speed dial' number, press "Enter" ← to access the list of stored programs.

Next either:

1. Scroll down to the required program using the "Up Arrow" and "Down Arrow" ↑ ↓ keys.
2. Or type the first letter of the program name in the "New program" field; this will then list all the program names beginning with that letter. Use the "Up Arrow" and "Down Arrow" keys ↑ ↓ to select the required program.

Press "Enter" to accept ←. For example 'Donna'.

To run the program, select 'Run program' and press "Enter" ←.

A screen similar to this one will appear.

Press "Enter" ← to start the run.

```

Cycle 4/30          56m08
Sample  58.0°C
Hold @  58.0°C     00m17
[      ▽ to STOP  ]

[      || to PAUSE ]
[      ↵ for info  ]
    
```

During the run the LCD screen will report:

1. The cycle number
2. The time remaining (counting down in seconds)
3. The sample temperature (whether holding or ramping)
4. The current step of the run
5. A count down of the hold time.

An example is shown here.

Manual pause

```

Cycle 24/30        19m26
Sample  72.0°C
Hold @  72.0°C     00m10
[      PAUSE?     ]

[      ↵ Yes or ▽ No ]
    
```

To pause a program while it is running, press "Pause" || The run will continue but the prompt line will alternate 'PAUSE?' and 'YES or NO'

To confirm that you want the program to pause press "Enter" ↵

If you have pressed the "Pause" key by mistake and you want the program to continue, press "End" ▽

The unit will emit a beeping sound while paused.

To resume the run, press "Pause" || followed by "Enter" ↵ to continue.

```

Cycle 24/30        19m26
Sample  72.0°C
Paused
[      ▽ to STOP  ]

[      || to CONTINUE ]
[      ↵ for info    ]
    
```

Manual stop

```

Cycle 24/30        10m39
Sample  94.0°C
Hold @  94.0°C     00m10
[      STOP PROGRAM? ]

[      ↵ Yes or ▽ No ]
    
```

To stop a program while it is running, press "End" ▽

The run will continue but the prompt line will alternate 'STOP PROGRAM?' and 'YES or NO'

To confirm that you want to stop the program press "Enter" ↵

If you have pressed the "End" ▽ key by mistake and you want the program to continue, press "End" ▽ again.

When a program is stopped the unit will emit a beeping sound and the original program screen will appear.

Program Information

```

DONNA
Heated Lid           on
Status               ramping
[   ↵ to exit   ]
    
```

Pressing "Enter" ↵ while a program is running will give information about the current run including which program is actually running and the unit status e.g. holding or ramping.

An example is shown here.

INFORMATION

```

Programs             [0]
Information
Configuration
[   ↑ ↓, ↵ to select ]
    
```

The **Information** field on the front screen contains all the unit-specific information such as serial number and software version.

Press "Enter" ↵ to access the unit information.

```

Block                48x0.2ml
Block s/n            139160-2
Unit s/n             GP0000-01
S/w version          14.zz
H/w version          01
Comms address        1
Unit cycles          624
Block cycles         69
    
```

The complete list is displayed here.

Note that the "Comms address" must be unique for each unit if more than one cycler is linked to a PC using the Gensoft control software.

CONFIGURATION

Warning! The Configuration software should only be accessed by designated personnel, as some parameters can be changed or may be lost when using it.

```

Programs             [0]
Information
Configuration
[   ↑ ↓, ↵ to select ]
    
```

The **Configuration** field on the front screen allows a system administrator access to set up all the default settings for the programs, time and date settings and to change and remove passwords.

```

CONFIGURATION
Password             pad█
[   ↵ to accept   ]

[   ▽ to exit   ]
    
```

Access to the 'Configuration' set up is password protected.

To enter configuration, use the alpha keys to type in 'pad'

Press "Enter" ↵

```

Program defaults
Settings
Passwords
Controller reset

```

Program defaults

```

Program defaults
Settings
Passwords
Controller reset

```

```

Heated lid           105°C
Preheat lid           on
Sample cooling         on
Pause                 off
-----
In denat    94.0°C    5m00
Hot start           off
-----
Final extn  72.0°C    5m00
Final hold   10.0°C
[  ↑ ↓ , ← to select ]

```

Settings

```

Program defaults
Settings
Passwords
Controller reset

```

There are a number of options which can be changed; these are listed here.

Use the "Up Arrow" and "Down Arrow" ↑ ↓ keys to select then press "Enter" ↵ to access any of the options. Each option is discussed in detail below.

Highlight 'Program defaults' then press "Enter" ↵

The complete list of program defaults is given here. These are the values that all new programs will take when you start to create a new program.

To edit any line use the "Up Arrow" or "Down Arrow" keys ↑ ↓ to select the line you wish to change.

Press "Enter" ↵ then change the value using the numerical keys. Press "Enter" ↵ to accept the new value.

To edit a field with on/off settings, first select the field and press "Enter" ↵

Use the "Up Arrow" and "Down Arrow" ↑ ↓ keys to toggle between the settings. Press "Enter" ↵ to accept.

When you have set all the defaults, press the "Enter" ↵ key to go back to the Configuration menu.

Note: altering the default values does not change existing programs.

Highlight 'Settings' then press "Enter" ↵

```

Set date      xx / xx / xx
Set time      xx : xx
Date format   dmy
Auto restart  on
Beeper       on
Coms address  1
Coms speed    4800
[  ↑ ↓ , ← to select ]

```

Passwords

```

Program defaults
Settings
Passwords
Controller reset

```

```

* * Admin passwd * *
DONNA
GEORGE
[  ↑ ↓ , ← to select ]

```

```

      ADMIN PASSWD
Password  █
Confirm
[  ← to accept ]

```

```

* * Admin passwd * *
DONNA
GEORGE
[  DEL PASSWORD? ]
[  ← Yes or ▽ No ]

```

The complete list of settings is given here.

Auto restart "on" will allow the unit to restart from where it left off should there be a power failure and the power returns.

The "Comms address" identifies individual units and must be unique if there are several units linked to each other.

The optimum "Coms speed" is set at 4800. When using the Gensoft control software, ensure all cyclers are set to the same value.

Edit any line as described for 'Program defaults' above. Press "Enter" ← to accept the new value.

When you have finished, press the "Enter" ← key to go back to the 'Configuration' menu.

The 'Passwords' function allows the administrator to change the 'Admin password' (which allows access to Configuration) and also to delete any passwords associated with programs.

Highlight 'Passwords' then press "Enter" ←

The screen will appear as opposite.

We suggest that you change the 'Admin password' at this stage in order to protect the configuration settings.

Use the "Up Arrow" ↑ key to highlight 'Admin passwd

'Press "Enter" ← and type in the new password. Repeat to confirm and accept.

The screen will go back to the 'Configuration' menu.

To delete a password associated with a program, use the "Up Arrow" and "Down Arrow" ↑ ↓ keys to highlight the program.

Press "Enter" ←

Press "Enter" ← again to delete the password.

Controller reset

Program defaults
Settings
Passwords
Controller reset

CONTROLLER RESET
This will delete
all programs
[SURE ?]
[← Yes or ▽ No]

The 'Controller reset' will delete all saved programs from the unit.

Highlight 'Controller reset' then press "Enter" ←

To delete all the programs, press "Enter" ←

GRADIENT CALCULATOR

It is not possible to view the actual temperatures of each column in the program or while the unit is running. Therefore for any set gradient, the gradient calculator can be used to calculate the temperatures for each of the columns and display them on the screen. This allows the user to determine the optimal amplification conditions for the assay.

```

Programs [0]
Information
Configuration
Gradient calculator
[ ↑ ↓ , ← to select ]
  
```

The **gradient calculator** field on the front screen allows a user to input a temperature and gradient range. It then calculates the temperatures for each of the columns.

```

Gradient calculator
Temp 50.0°C   Grad 5.0°C
Column 1      47.5°C
[ ↑ ↓ , ← to select ]
  
```

From the front screen scroll down to Gradient calculator.

Press "Enter" ←

```

Gradient calculator
Temp 55.0°C   Grad 5.0°C
Column 1      47.5°C
[   edit temperature   ]
  
```

Press "Enter" ← again to edit the temperature and gradient range.

```

Gradient calculator
Temp 55.0°C   Grad 10.0°C
Column 1      50.5°C
Column 2      51.6°C
Column 3      53.2°C
Column 4      55.2°C
Column 5      56.9°C
Column 6      58.2°C
Column 7      59.1°C
Column 8      59.6°C
[ ↑ ↓ , ← to select ]
  
```

Press "Enter" ← when finished and use the "Up Arrow" and "Down Arrow" ↑ ↓ keys to scroll through the list of column temperatures.

RUNNING THE TC-3000G FROM A PC

The TC-3000G can be run from a PC using Bibby Scientific Ltd's Gensoft software. Instructions for using Gensoft are included in a separate manual.

Connecting one unit to a PC

To connect a single TC-3000G unit, connect the unit to the PC using the USB cable, part number 6205046.

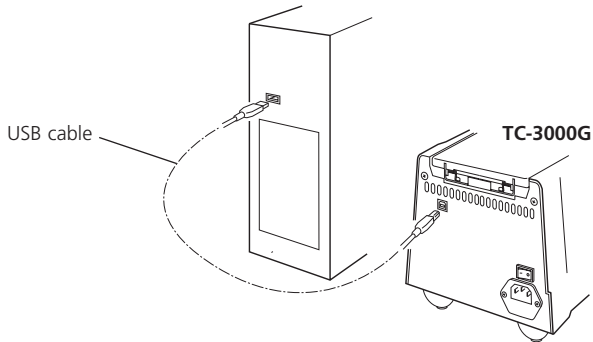

Connecting several TC-3000G units to a PC.

If you are driving two or more units then you will need a USB cable for each unit, part number 6205046 plus a hub, which will connect multiple units together.

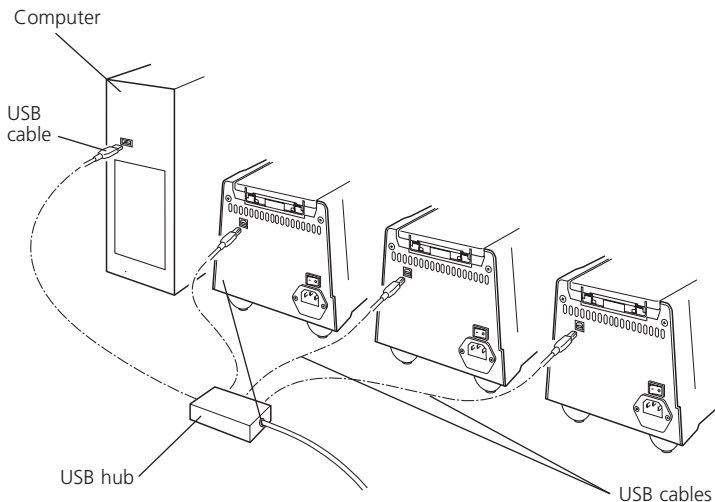

NOTES ON TRANSFERRING PROTOCOLS FROM OTHER THERMAL CYCLERS

The TC-3000G can heat up to 3.3°C/s and provides the highest levels of temperature uniformity. Many slower machines have historically begun the countdown on hold times before the set temperature is reached in order to avoid any overshooting in sample temperature. The slower the heating rate the more significant the loss in hold time, i.e. if a 30 second hold time is set at 55°C then perhaps 5 to 10s will be lost in between the start of the time countdown and actually reaching the set temperature. The overall effect of this method of control is that your sample, if cooling from a higher temperature, is subjected to an environment with an elevated temperature compared to the target temperature for a significant part of the hold time.

The TC-3000G provides the user with 'what-you-program-is what-you-get'. Due to the rapid and responsive nature of the Peltier heating system, the time between the timer countdown initiating and actually reaching the set temperature has been reduced to as little as 1s. This ensures that the sample is only subjected to the exact temperature required.

Taking the above into consideration it must therefore be noted that care must be taken when re-optimizing protocols from a slower machine.

Trouble Shooting

1. The optimum annealing temperature may in fact be higher than the set temperature used in the slower machine. Try increasing it by 1 or 2°C.
2. The hold time can be reduced once the optimum temperature has been found. Try reducing it by 5 to 10s.

USER MAINTENANCE

CLEANING YOUR TC-3000G

Before cleaning your unit, disconnect from the power supply and allow it to cool to below 50°C.

CLEANING YOUR BLOCK

The heating/cooling block, including wells and flat surfaces, should be cleaned regularly to ensure optimum heat transfer to the samples. Always clean the block if there has been a spillage. Use a cloth or cotton buds dipped in a fresh, 50:50 water/isopropanol solution and make sure that no deposits are left in the wells.

In the case of radioactive spillages the heater block can be removed from the unit for more detailed cleaning. Bibby Scientific Ltd recommends that you use a proprietary cleaning agent and follow the manufacturer's instructions. The heating/cooling block is made of aluminium, therefore an agent such as Neutracon (from Decon Labs Ltd.), suitable for nonferrous metals should be used. However, remember that other parts of the unit are made of ferrous materials and may be damaged by spillage onto them.

HEATER BLOCK REMOVAL

 Removing the block may expose the possibility of electric shock; disconnect the unit from the mains and allow to cool below 50°C before continuing. Remove the four screws on the underside of the unit and drop the block/fan assembly down. Unplug the assembly from the wiring and remove the assembly from the unit. Refitting the block/fan assembly is the reverse procedure; be careful of the wires as you refit the block.

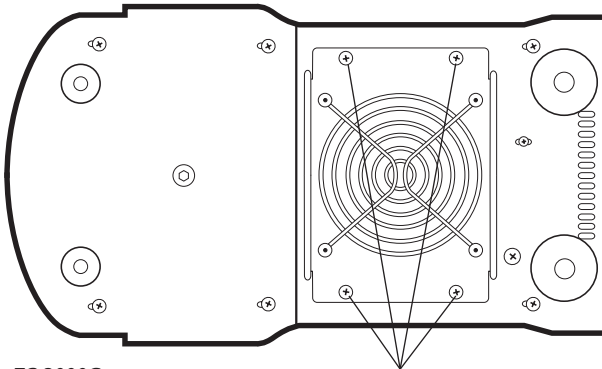

Underside of the TC-3000G

Four screws which hold the block/fan assembly in place

CLEANING YOUR CASE

The outer case of the TC-3000G can be cleaned with a cloth dipped in water or ethanol (50:50 methanol/water or 99:1 water/formaldehyde can also be used). No part of the case or cover should be immersed in the solvents. Do not use aggressive solvents such as acetone, or abrasive cleaners. Before using any cleaning or decontamination method except those recommended here, the responsible person should check with Bibby Scientific Ltd that the proposed method will not damage the equipment.

SOME FREQUENTLY ASKED QUESTIONS

Q1 What is the 'Pause' function at the start of the program used for?

A1 Some users prefer to preheat the heated lid before placing the samples into the unit. The pause feature is used to stop the unit after the 4 minute heated lid preheat step. It will also sound an audible alarm indicating that the machine is ready for the sample tubes or plate to be added. Pressing the "Pause" key followed by the "Enter" key will commence the remaining program.

Q2 Why do you have to press some keys twice to make the unit do what you want it to do?

A2 With many of the program features there is a fail-safe function which asks if you are sure you want to perform a particular action. You are required to press one key to select a function followed by a second to accept it.

Q3 What is 'Hot Start'?

A3 A "hot start" is used for reducing non-specific product formation during the first cycle of amplification. The 'Hot Start' programming step is used to pause the instrument at a specific temperature, typically around 70°C, after the initial template denaturation. The reason is to allow the manual addition of unmodified Taq DNA polymerase which may lose activity if added during the initial 5min denaturation. Heat-activated Taq or Hot Start enzymes do not require this step.

Q4 What is the incremental function?

A4 Incremental timing and temperature are used to increase or decrease either the time or temperature incrementally over the number of cycles in a stage.

Incrementation of extension time is used with 'Long PCR' which is when large template fragments are to be amplified (e.g. 27kb lambda DNA, 40kb genomic DNA).

Decremental temperature is used for protocols such as 'Touchdown PCR' where one starts with a high annealing temperature in the first cycle and gradually decreases the temperature over the number of cycles in the stage. This ensures that only the specific product is amplified.

Q5 The heat-up ramp-rate in the specification is 3.3°C/second yet I can only manually set it to 2.0°C/second. Why is this?

A5 If you set the ramp-rate to max the block will heat at 3.3°C/second the unit sets its own control parameters. If you program a ramp-rate the control parameters reduce the ramp-rate. This is a feature of the software and not the actual ramp-rate.

If you require further technical or applicational assistance please contact Bibby Scientific Ltd at: **technehelp@bibby-scientific.com**.

For servicing information please contact: **service@bibby-scientific.com**.

We are continually striving to improve our thermal cyclers and software. If you have any comments and suggestions on how we can do things better please send them to us at:

techne@bibby-scientific.com

ADDITIONAL INFORMATION

Brief fault finding notes and a list of replacement parts are given in this section.

Note that this equipment should only be dismantled by properly trained personnel. Removing the outer cover exposes potentially lethal mains voltages. There are no user serviceable parts within this equipment.

FAULT FINDING

Should you have any problems with your unit which cannot be easily remedied, you should contact your supplier and return the unit if necessary. Please include details of the fault observed and remember to return the unit in its original packing. Bibby Scientific Ltd accepts no responsibility for damage to units which are not properly packed for shipping: if in doubt, contact your supplier, giving the full serial number of the unit and software version number (shown when the unit is first switched on).

FUSES

If neither the power light nor display on the front panel is lit, one of the two fuses may have blown. Check that there is no external cause, such as a faulty plug or lead. Check both fuses and replace the faulty fuse with a new one of the correct value (fuse values are given on the label next to the power inlet). Note that fuses should only be replaced by a qualified electrician.

The holder for the two fuses is built into the mains input socket. First remove the power cable and then gently prise the fuse drawer open with a flat-bladed screwdriver or similar tool.

Each fuse can be removed by using the screwdriver as a lever.

Exchange both fuses in the fuse holder for a working fuse of the correct value. Finally, replace the fuse drawer in the fuse compartment and push the drawer shut.

Fuses which blow repeatedly indicate a serious fault and you should return the unit to your supplier for repair.

THE HEATED LID OVER-TEMPERATURE CUT-OUT

The heated lid is fitted with an independent circuit to protect it from overheating. In the unlikely event of an over-temperature problem with the lid, the unit is fitted with a thermal fuse which will remove power to the heater plate should the maximum temperature be exceeded. If this fault occurs, contact your local supplier for repair.

INSULATION TESTING

This equipment is fitted with RFI suppression circuitry. Any check of the electrical insulation by means of high voltage dielectric testing (for example as in BS EN 61010-1) must be carried out using only a DC voltage.

This unit contains semiconductor components which may be damaged by electric field effects.

INTERCHANGEABLE BLOCKS

The block can be removed and replaced by another of the same sort or of a different sort. The software will register the change and set up the unit for the new block.

Remove the four screws on the underside of the unit and drop the block/fan assembly down. Unplug the assembly from the wiring and remove the assembly from the unit. Refitting the block/fan assembly is the reverse procedure; be careful of the wires as you refit the block.

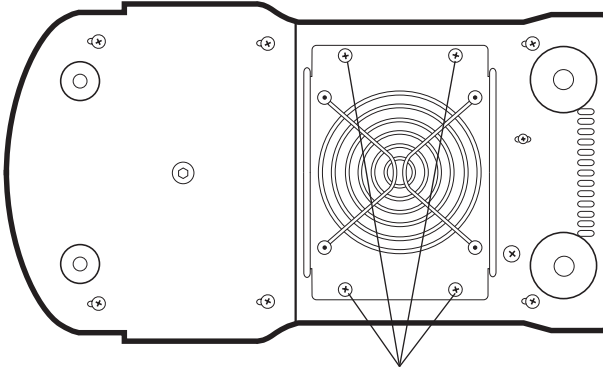

Underside of the TC-3000G

Four screws which hold the block/fan assembly in place

ACCESSORIES

The following accessories can be obtained from Bibby Scientific Ltd or your Bibby Scientific Ltd dealer:

Item No	Description	Quantity
FTC3G/02/B	0.2ml Tube block for TC-3000G	1
FTC3G/05/B	0.5ml Tube block for TC-3000G	1
FTUB02TW	0.2ml Micro tubes	Pack of 1000
FTUB05TW	0.5ml Micro tubes thin wall	Pack of 1000
FSTRIP2	Strips of 0.2ml tubes for use with flat or domed caps	Pack of 125 strips
FSTRIP3	Strips of 0.2ml tubes, each tube has individual flat cap	Pack of 120 strips
FSTRIP4	Strips of 0.2ml tubes with attached, hinged strip of domed caps	Pack of 125 strips
F8CAP2	Strips of 8 domed caps for use with FSTRIP2	Pack of 125 strips
F8CAP3	Strips of 8 flat caps for use with FSTRIP2	Pack of 125 strips
FCOOL	Mini cooler. Suitable for all 0.2ml tubes, strip tubes & plates	1
F24PLNS	24 well plate, non-skirted	40 plates
F48PLNS	48 well plate, non-skirted	20 plates
F24MAT	24 well sealing mat (silicone) for use with F24PLNS	10 mats
F48MAT	48 well sealing mat (silicone) for use with F48PLNS	10 mats

REPLACEMENT PARTS

The following replacement parts can be obtained from Bibby Scientific Ltd or your Bibby Scientific Ltd dealer:

Item No	Description	Quantity required
FCABRTUK	Mains cable and plug, 230V UK	1
FCABRTEU	Mains cable and Schuko plug, 230V Europe	1
FCABRTUS	Mains cable and 3-pin plug, 100V/120V US type	1
6500342	Fuse T6.3A	2
6106196	Heated lid mat	1



Bibby Scientific Ltd

Beacon Road Stone
Staffordshire ST15 0SA
United Kingdom
Tel: +44 (0)1785 812121
Fax: +44 (0)1785 813748
email: techne@bibby-scientific.com
www.bibby-scientific.com

Bibby Scientific France SAS

ZI du Rocher Vert - BP 79
77793 Nemours Cedex
France
Tel: +33 1 64 45 13 13
Fax: +33 1 64 45 13 00
e-mail: bsf@bibby-scientific.fr
www.bibby-scientific.com

Techne Inc.

3 Terri Lane Suite 10
Burlington NJ 08016
USA
Tel: 800-225-9243
Fax: 609-589-2571
email: labproducts@techneusa.com
www.techneusa.com

Bibby Scientific Italia Srl

Via Alcide de Gasperi 56
20077 Riozzo di Cerro al Lambro
Milano Italia
Tel: +39 (0)2 98230679
Fax: +39 (0)2 98230211
e-mail: marketing@bibby-scientific.it
www.bibby-scientific.it

Bibby Scientific (Asia) Ltd

Room 607 Yen Sheng Centre
64 Hoi Yuen Road Kwun Tong
Kowloon Hong Kong
Tel: +852 3583 1581
Fax: +852 3583 1580
e-mail bibby@bibby-scientificasia.com
www.bibby-scientificasia.com