

CompactConnect

Basics

[Installation](#)

[Connection Sensor - Computer](#)

[RS485/ RS422 \[CT/ CTlaser/ CTratio\]](#)

[Easy Start-Up](#)

[Basic Settings](#)

[Digital Displays](#)

[Views](#)

[External Displays](#)

[Multiple Software Calls](#)

[Start Measurement](#)

[Scaling of the Temperature Axis](#)

[Stop Measurement and Save Data](#)

[Measurement Configuration](#)

[Opening of Files](#)

Special Features

[Loop Maintenance](#)

[Saving the Sensor Configuration](#)

[Emissivity Calculation](#)

[Smart Averaging](#)

[Binary Chat Program](#)

[Double Sensoring/ Input Monitoring](#)

[Diagram Compression](#)

Menus

[Menu Overview](#)

CT / CTlaser / CTvideo

[Sensor Setup CT/ CTlaser/ CTvideo - Signal Processing](#)

[Emissivity and Transmissivity](#)

[Material Table](#)

[Ambient Temperature Compensation](#)

[Post Processing](#)

[Signal Graphs](#)

[Sensor Setup CT/ CTlaser/ CTvideo - Output Signals](#)

[Output Channel 1](#)

[Output Channel 2](#)

[Visual Alarms](#)

[Sensor Setup CT/ CTlaser/ CTvideo - Adv. Settings](#)

[Head Parameter](#)

[Lock Programming Keys](#)

[Device Adjustment/ Temperature unit](#)

[RS485 Multidrop Address](#)

[Video Settings](#)

[Video Snapshots](#)

CompactConnect

CTratio

[Sensor Setup CTratio – Output Signals](#)

[Output Channel 1](#)

[I/O pins](#)

[Sensor Setup CTratio – Signal Processing](#)

[Emissivity/ Slope/ Attenuation](#)

[Post Processing](#)

[Sensor Setup CTratio – Visual Alarms](#)

[Sensor Setup CTratio – Advanced Settings](#)

[Lock Programming Keys](#)

[Temperature unit](#)

[RS485 Multidrop Address](#)

[Calibration](#)

CSlaser / CSvideo / CX

[Sensor Setup CSlaser/ CSvideo/ CX](#)

[General \[CX\]](#)

[General \[CSlaser/ CSvideo\]](#)

[Analog Output \(mA\)](#)

[Digital Output](#)

[Open Collector Alarm Output](#)

[Post Processing – Peak/ Valley Hold](#)

[Calibration](#)

[Video Settings](#)

[Video Snapshots](#)

CS/ CSmicro

[Sensor Setup/ General](#)

[IN/ OUT \(green\) – ext. Emissivity/ Ambient temp.](#)

[IN/ OUT \(green\) – ext. Trigger](#)

[IN/ OUT \(green\) – Communication input](#)

[IN/ OUT \(green\) – Alarm Output \(open collector\)](#)

[IN/ OUT \(green\) – Temp. Code Output \(open collector\)](#)

[Analog Output \(mA\)/ Alarm Output](#)

[OUT \(yellow\) – Analog Output \(mV\)/ Alarm Output](#)

[OUT \(yellow\) – 3-state Output](#)

[OUT \(yellow\) – Digital Outputs](#)

[Status LED – LED Alarm/ Automatic Aiming Support](#)

[Status LED – Self Diagnostic](#)

[Status LED – Temperature Code Indication](#)

[Signal Processing](#)

[Vcc Adjust](#)

[Calibration](#)

Installation

Insert the installation CD into the according drive on your computer. If the autorun option is activated the installation wizard will start automatically. Otherwise please start **CDsetup.exe** from the CD-ROM.

After pressing the button **Install Compact Connect** the software will be installed on your PC. The installation wizard will place a launch icon on the desktop and in the start menu: **[Start]\Programs\CompactConnect**.

Now please press the button **Install Adapter driver** – all necessary device drivers will be installed. After connecting new sensors or new USB adapter cables to your PC the system will allocate them to the correct driver automatically.

If the **Found New Hardware Wizard** appears you can select **“Connect to Windows Update”** or **“Install the software automatically”**.

The button **Install Ethernet Driver** will only be needed if the Ethernet interface is used (CT/ CTlaser). **EXIT** will close the installation wizard.

Minimum system requirements:

- Windows XP, Vista, 7
- USB interface
- Hard disc with at least 30 MByte free space
- At least 128 MByte RAM
- CD-ROM drive

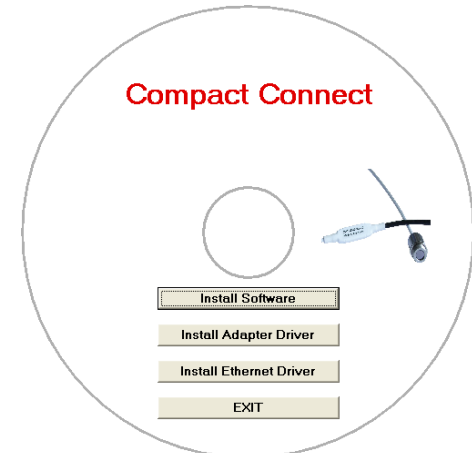

Connection Sensor - Computer

If you connect your sensor to your PC and start the software, the following message will appear (if option **Auto scan device** is activated). ► **Basic Settings/ Options:**

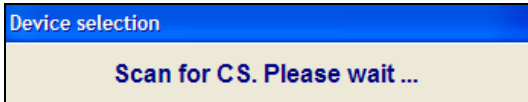

If the Auto Scan Device option is deactivated, please open at first **[Menu: Preferences\ Interface]**.

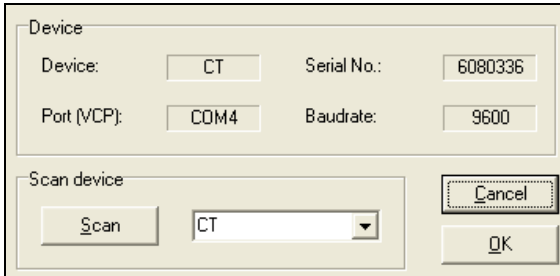

You can predefine the search for connected sensors as follows:

- All
- CS/ CSM/ CX/ CSL/ CSM v2
- CT (incl. CTlaser, CT XL, CTratio)

Then please press the **Scan** button. All sensors found will be shown in a selection screen:

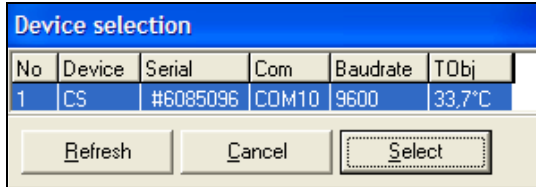

The screenshot shows a dialog box titled "Device selection" with a blue header. It contains a table with the following data:

No	Device	Serial	Com	Baudrate	TObj
1	CS	#6085096	COM10	9600	33,7°C

Below the table are three buttons: "Refresh", "Cancel", and "Select". The "Select" button is highlighted with a dashed border.

Example 1: A sensor (CS) was found. Press **Select** to close the window.

Refresh starts a new search.

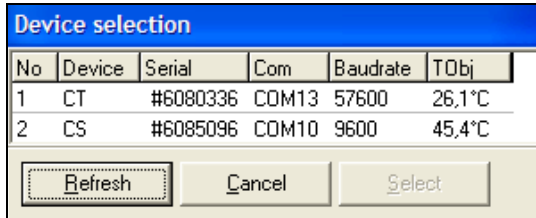

The screenshot shows a dialog box titled "Device selection" with a blue header. It contains a table with the following data:

No	Device	Serial	Com	Baudrate	TObj
1	CT	#6080336	COM13	57600	26,1°C
2	CS	#6085096	COM10	9600	45,4°C

Below the table are three buttons: "Refresh", "Cancel", and "Select". The "Refresh" button is highlighted with a dashed border.

Example 2: Two sensors (CT and CS) were found. Please activate with the cursor the desired unit and after that press the **Select** button to close the window.

Refresh starts a new search.

After the selection of a sensor you will get to the previous screen again. Here you will find now information about the used virtual COM port (VCP), the serial number and the baud rate.

ONLY CS/ CSMICRO

If CS/ CSMicro sensors are selected you will find in addition the button **Power On** in this screen. With this function you can operate your sensor as analog device (mV or mA output). The USB interface of your computer will act only as power supply in this case.

After you have pressed **Power On** the sensor will be powered via USB, but operates in the analog mode (mV output via OUT pin).

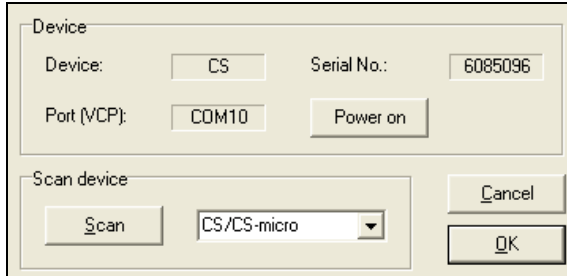

The screenshot shows a software window with the following fields and buttons:

- Device:** Device: CS, Serial No.: 6085096
- Port (VCP):** COM10, Power on button
- Scan device:** Scan button, CS/CS-micro dropdown menu, Cancel button, OK button

To use this feature the window must stay open – if you press OK the window will close and the sensor will go back to the communication mode.

To finish please press **OK**. The window will be closed.

If **Auto start device** is activated ► **Basic Settings/ Options** the measurement starts and the temperature values will be shown in the diagram.

After the sensor selection the status line (below the time axis) shows the following information:

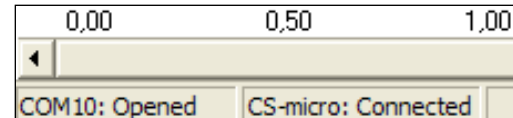

COMxx: Opened active COM port

CT/ CS/ CSmicro: Connected successful communication with the connected sensor

RS485/ RS422 [CT/ CTlaser/ CTratio]

If a RS485 interface is used please activate the **RS485 Mode [Menu: Preferences\ Interface]**. After selection of **COM port, Baud rate** and **Sensor address** (both of these values must be identical with the settings on the unit) please press **Connect**. In RS485 mode up to 32 sensors can be connected in one network. The CompactConnect can only display one sensor at once.

For a faster data transfer we recommend the **RS422 mode**. You will need also the RS485 module and the RS485-USB adapter [**ACCTRS485USBK**]. To activate the RS422 mode you have to call this function with the programming keys on the sensor at first (menu item: multidrop address). Now you can connect the sensor as described under ► **Connection Sensor – Computer**. The RS485 Mode must be deactivated in this case.

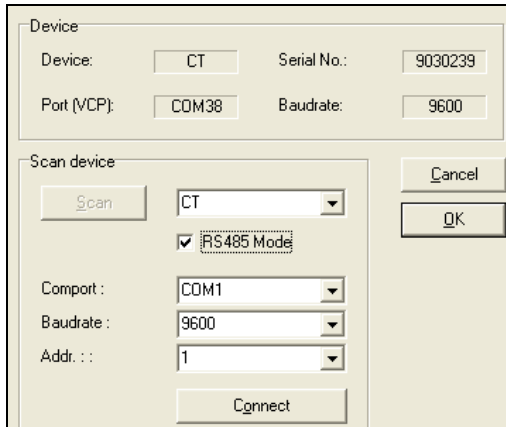

The screenshot shows a software window with the following fields and controls:

- Device:** CT, Serial No.: 9030239
- Port (VCP):** COM38, Baudrate: 9600
- Scan device:** Scan button, dropdown menu set to CT, RS485 Mode, Cancel button, OK button
- Comport:** COM1
- Baudrate:** 9600
- Addr.:** 1
- Connect** button

Easy Start-Up

If you restart the software and the last used sensor is connected to the computer and the **Auto scan device** option is activated ► **Basic Settings/ Options** the connection will be made automatically (without sensor selection window).

If this option is deactivated, please press the **Connect** button in the tool bar or **[Menu: Device\ Scan Device]**.

The button **Disconn.** or **[Menu: Device\ Disconnect Device]** breaks the connection to the sensor and closes the COM port.

Basic Settings

LANGUAGE

You can choose the desired **language** in the menu **[Menu: Preferences\ Language]**.

OPTIONS

The menu item **[Menu: Preferences\ Options]** allows the following settings:

<input type="checkbox"/> Ask for saving	Decimal separator
<input type="checkbox"/> Force data saving after "stop"	<input checked="" type="radio"/> System
<input type="checkbox"/> Scan non-USB devices	<input type="radio"/> User defined: <input type="text"/>
<input checked="" type="checkbox"/> Auto scan device	Application title:
<input type="checkbox"/> Auto start device	<input checked="" type="radio"/> Application name
<input checked="" type="checkbox"/> Enable button to toggle LASER	<input type="radio"/> User defined: <input type="text"/>
<input checked="" type="checkbox"/> Warning message if LASER ON	Temperature unit
<input checked="" type="checkbox"/> Enable button to toggle Video	<input checked="" type="radio"/> °C <input type="radio"/> °F
<input checked="" type="checkbox"/> CS rev. 2 - Input monitoring	System priority
<input type="button" value="Setup uncommitted value"/>	Priority : <input type="text" value="normal"/>
<input type="button" value="Cancel"/>	<input type="button" value="OK"/>

Scan non-USB devices

Activate this option, if you use sensors with other interfaces (non-USB) e.g. CT with RS232 or Ethernet interface.

Auto scan device

If activated, after each program start the software is looking for connected devices.

Auto start device

Enable button to toggle LASER

Warning message if LASER ON

Enable button to toggle Video

CS rev. 2 – Input monitoring

Application title

Temperature unit

If activated, after each program start the measurement will be started automatically (if connected sensors have been found before).

[CTlaser, CSLaser, CTratio only] If activated, an additional button to switch on and off the laser will be shown in the tool bar and in the menu **[Menu: Device]**

[CTratio only] If activated, a warning message will appear inside the diagram (if the laser is activated) that the measurement has been stopped **[▶ Sensor manual CTratio]**

[CTvideo, CSvideo only] If activated, additional buttons for Video and Snapshot will be shown in the tool bar.

[CS/ CSmicro v2 only] Must be activated for display of additional values (mV in, Vcc, Eps, TAmb)

Selection between the program name of the manufacturer or a user defined name. The title will be shown in the top line of the program window.

Selection between °C and °F **[CS, CSmicro only]**.

For all sensors of the CT series this selection has to be made under: **[Menu: Device\ Device Setup]**.

[▶ Sensor Setup CT – Temperature unit](#)

The further options are described under **[▶ Stop Measurement and Save Data.](#)**

DIAGRAM SETTINGS

The menu item Settings [**Menu: Diagram\ Settings**] enables the selection of the following diagram options:

	Digital Display	Diagram Display	Diagram Auto range	Pen width:	Color
TProcess	<input checked="" type="checkbox"/>	<input checked="" type="checkbox"/>	<input checked="" type="checkbox"/>	2	Blue
TInt	<input type="checkbox"/>	<input type="checkbox"/>	<input type="checkbox"/>	2	White
TBox	<input checked="" type="checkbox"/>	<input type="checkbox"/>	<input type="checkbox"/>	2	Red
TAct	<input type="checkbox"/>	<input type="checkbox"/>	<input type="checkbox"/>	2	White
T_2C	<input checked="" type="checkbox"/>	<input type="checkbox"/>	<input type="checkbox"/>	2	Green
T_1C	<input type="checkbox"/>	<input type="checkbox"/>	<input type="checkbox"/>	2	Teal
Attenuation	<input type="checkbox"/>	<input type="checkbox"/>	<input type="checkbox"/>	2	Green
x-axis time range [s]:			5,000		

OK Cancel

Digital Display

Selection which signals should be displayed as digital display

Diagram Display

Selection which signals should be displayed as graph

Diagram Auto range

Selection, for which signal graphs an auto scaling should be active

Pen Width

Pen width of the temperature graphs **[1...5]**

Color

Color of the temperature graph and digital displays

x-axis time range

Time frame on the x-axis, which should be displayed at the beginning of a measurement

Digital Displays

If the sensor is connected to your computer and you start the software, the object temperature **TProcess** will be shown as digital display (top right).

You can add additional displays **[Menu: View\ Digital]**. Dependent on the sensor type the available signals may vary.

TProcess includes the current post processing functions (average, peak hold, etc.).

The once selected displays will also appear after a restart of the software. The **size** can be changed if you put the cursor on the line beneath the display and pull it down. The buttons of the tool bar will also be moved (depending on the display size).

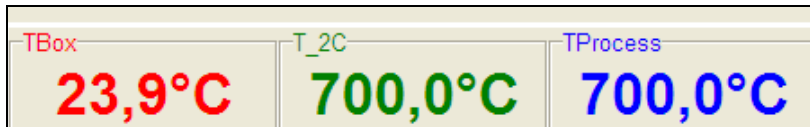

The colors of the different displays are equal to the colors selected under **[Menu: Diagram\ Settings]** for the corresponding temperature graphs. ► **Basic Settings**

Double Sensoring/ Input Monitoring

On the CS and CSmicro mV (Rev. 2) the following additional values can be visualized in the diagram and shown as digital display:

mV in	Voltage at pin IN/ OUT if used as functional input (display of an free scalable uncommitted value)
Vcc	Supply voltage
Eps	Emissivity value
TAmb	Value for external ambient temperature compensation

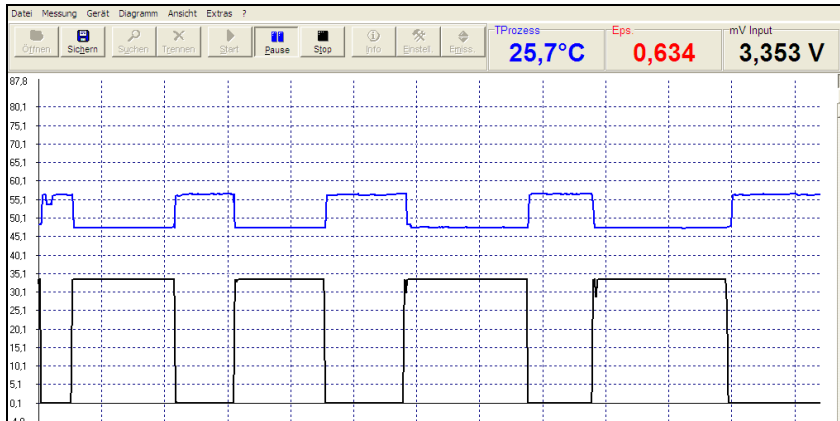

Example: External emissivity setting via an analog voltage at the pin IN/ OUT. The graph allows an analysis of the process temperature change in dependence on the set emissivity.

For a display of the input monitoring please activate **CS rev. 2 – Input Monitoring**

[Menu: Preferences\ Options]

After this please push the button **Setup uncommitted value**. You can enter the desired name and unit for the uncommitted value and make the range scaling:

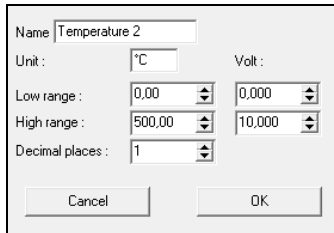

Now you can open the device settings **[Menu: Device\ Device Setup]** and select double sensing on the tab **OUT**. After closing and restart the software with the [command line parameter](#) **/DS=xx,yy**¹⁾ the program will start directly in the diagram mode. The sensor is operating in the burst mode now.

A return to the sensor configuration is only possible by starting the CompactConnect without parameter.

¹⁾ /DS=xx,yy: xx = COM-Port number yy = device type (CS= CSv2 / CSM LT= CSMBV / CSM 3M= CSMBV3M)

Example:

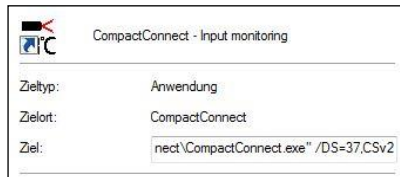

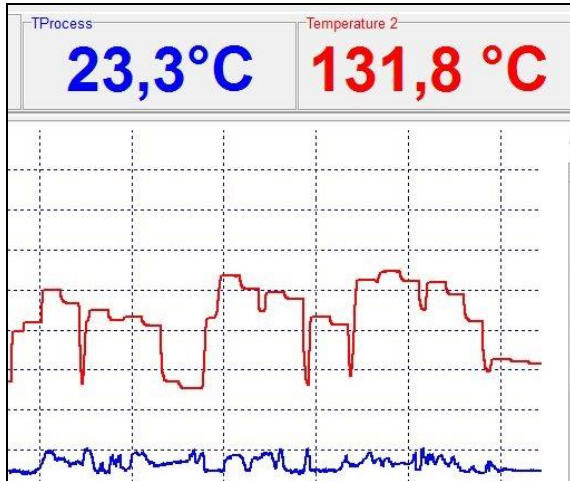

Example: Double sensing with a second IR sensor (value “Temperature 2”) whose output is connected directly to the IN/ OUT-Pin of the CS/ CSmicro.

Views

The CompactConnect allows the creation of free definable screens and views:

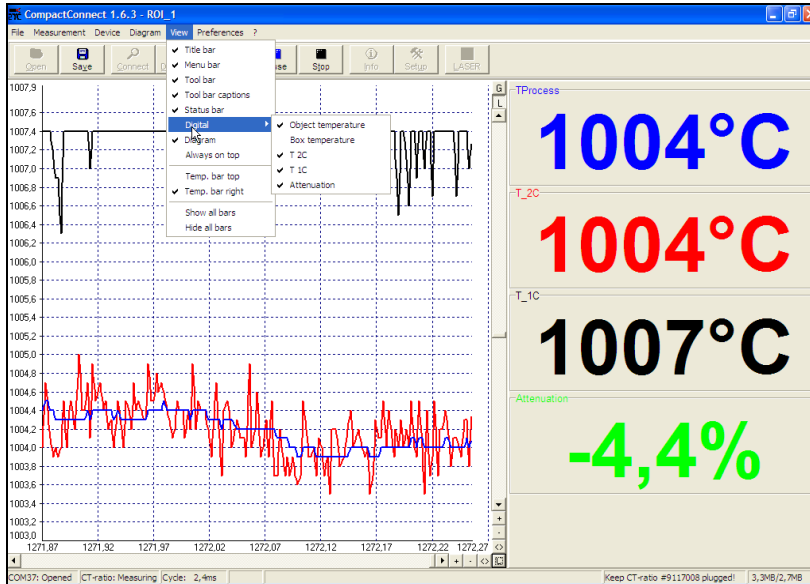

The digital displays can be arranged optional on top or right side [**Menu: View\ Temp. displays top or Temp. displays right**].



You can show the digital displays also separate by hiding of selected information (e.g. title bar, menu bar, etc.) in any size ► **Digital Displays** and, if desired, also always on top of your PC screen [**Menu: View\ Always on top**].

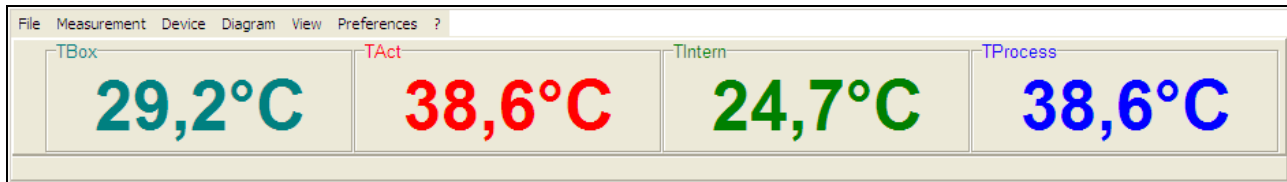

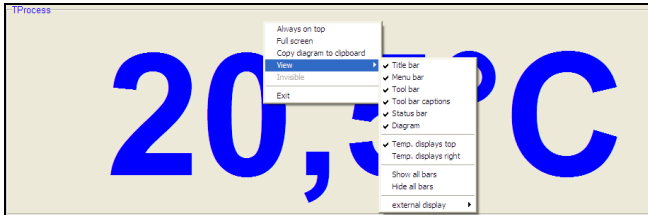

The view menu can also be called from the context menu (right mouse button).

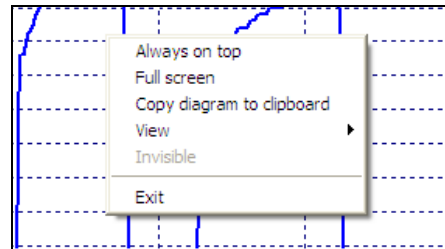
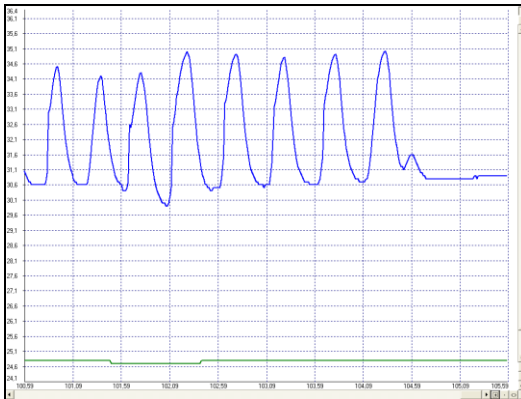

Separate diagram screen – this screen can be inserted into other applications (Word e.g.) by using the copy to clipboard function (right mouse button). This functionality allows an easy print-out of a diagram.

External Displays

By double click on one of the digital displays **[Menu: View\ External Display]** you can start an external display for the respective signal. This display will appear initially in the same color than the respective display in the software. By drag and drop these external displays can be placed at any desired location on the PC screen (the position of the according software display will not change). For an easy positioning a mark will appear on the left of the display if crossed with the cursor:

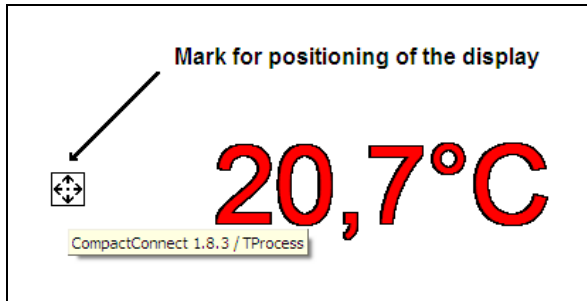

To distinguish between several displays the name of the software/ instance (for multiple software calls) as well as the signal name will be shown shortly.

There are different options available for the design of the external displays which can be called with the right mouse button:

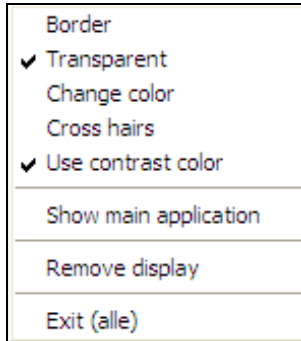

Border

Presenting the display with a border – in this mode the size of the display can be changed.



Transparent

Transparent presenting – useful for a positioning of the display in front of pictures or wallpapers.



Change color

For changing the display color

Cross hairs

To show cross hairs which can be positioned independent on the external display.



Use contrast color

Dependent on the used background the presenting of the display figures with contrast color (black edging) can be useful.

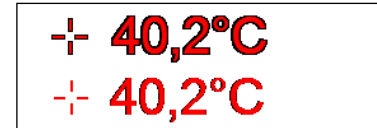

Show main application

Calls the window of the main application (out of the invisible mode e.g.)

Remove display

Closes the associated external display

Exit (all)

Closes all external displays as well as the main application.

Application examples for external displays

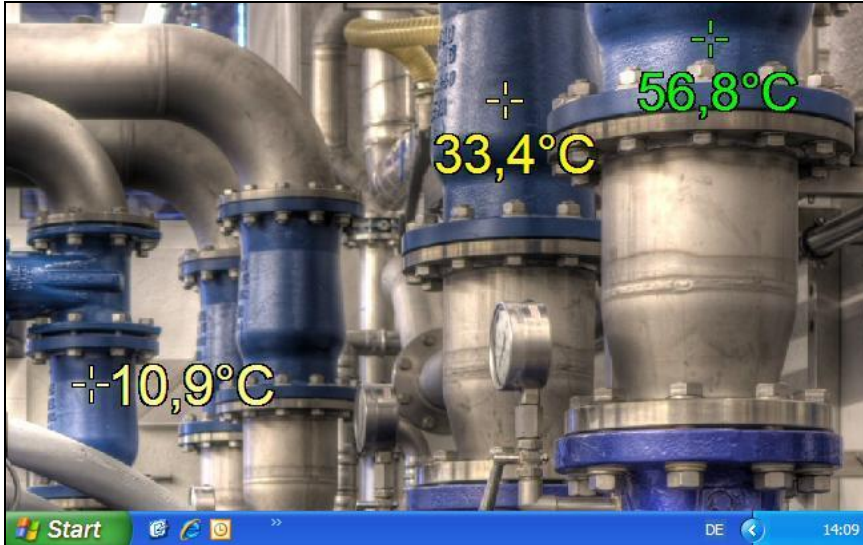

Temperature displays in front of a static machine view

The picture of an industrial plant or of a process is used as wallpaper on the computer. The single instances of the CompactConnect are running in the invisible mode. The external displays are positioned that they are showing the real measurement targets on the plant. After a reboot of the computer the CompactConnect is started automatically via the autostart feature and the external displays are appearing on the previously defined positions.

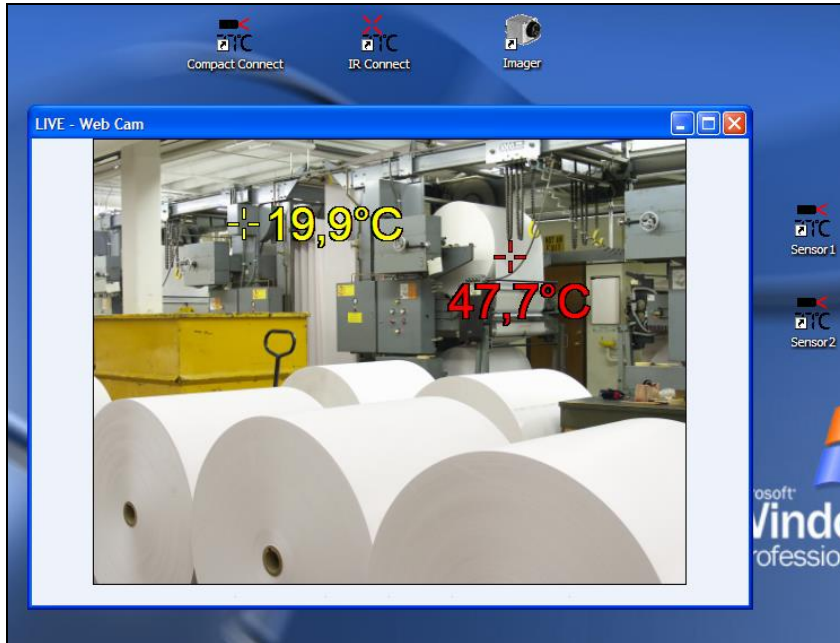

Temperature displays in front of a live picture

A camera is showing the live picture of an industrial plant or a machine. As in the previous example the external displays are pointing to the real measurement targets on site showing the current temperatures inside the live picture.

Multiple Software Calls

Command Line Parameters

The software can be started with different command line parameters.

You will get an overview if you enter **[blank space] /?** behind the program call in the shortcut (properties).

If you start the application now the following window will appear:

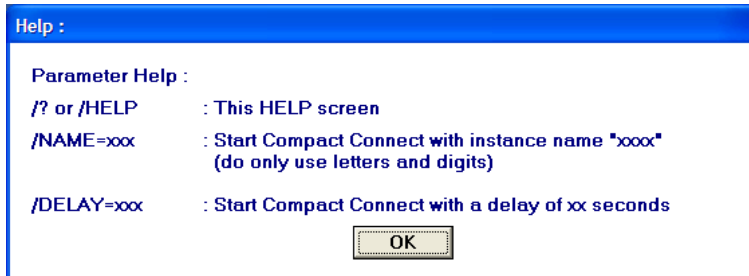

The parameter **/NAME** allows a multiple start of separate software instances for displaying different instruments simultaneously.

The parameter **/DELAY** should be used, if several instances of the software are started at the same time. It prevents possible conflicts which can be caused by simultaneous access to the virtual COM ports.

Also a combination of both parameters is possible (see next page).

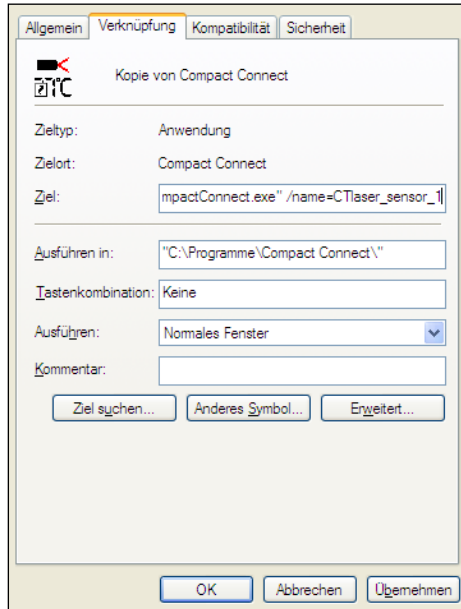

Please make at first a copy of the existing shortcut on your desktop. Under properties you have to add now at the end of the line:

"C:\Programme\Compact Connect\CompactConnect.exe"
a blank space and after:
/Name=example

Example can be the desired sensor or measurement location name.

To start those different instances automatically shortcuts can be copied into the **autostart** folder or called with the help of a **batch file (*.bat)**:

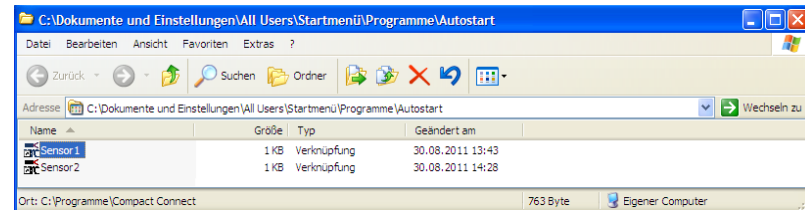

Autostart folder with two instances of the CompactConnect

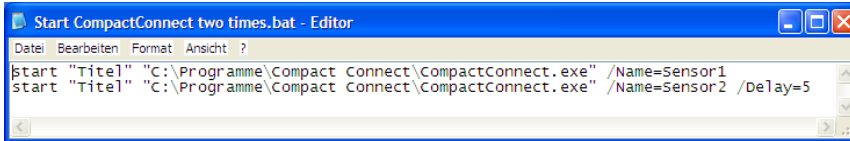

```
Start CompactConnect two times.bat - Editor
Datei Bearbeiten Format Ansicht ?
start "Title1" "C:\Programme\Compact Connect\CompactConnect.exe" /Name=Sensor1
start "Title1" "C:\Programme\Compact Connect\CompactConnect.exe" /Name=Sensor2 /Delay=5
```

Batch file for an automatized call of two instances of the CompactConnect

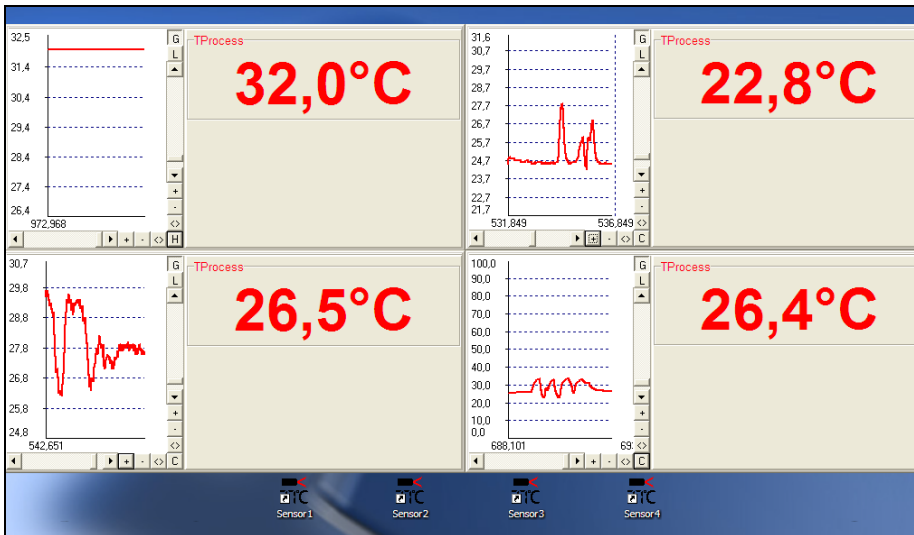

Four displays with diagrams are showing the temperature of four via USB connected sensors

Start Measurement

To start a measurement please press the **Start** button in the tool bar [Menu: Measurement\ Start].



Control elements of the time axis:

- 1 Scroll bar
- 2 Zoom in (increase)
- 3 Zoom out (decrease)
- 4 Whole range
- 5 H: Hold/ C: Continue

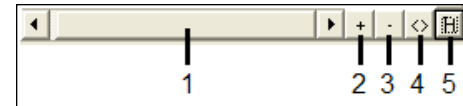

Any activation of a control element of the time axis or of the **Pause** button will stop the further actualization of the measurement graph. The measurement itself continues in the background. To return to the current measurement graph please press the **Pause** button again [**Menu: Measurement\ Pause**] or **C**.

During the stopped status any parts of the diagram can be selected with the **Time scroll bar**. With the zoom in-button **+** these parts can be stretched (enlarged) and with the zoom out-button **-** clinched (minimized).

Time information



During the **Pause** mode the real date and time can be displayed for a certain position by clicking into the diagram. In addition the according temperature values of that position are shown.

Scaling of the Temperature Axis

With **global scaling** the temperature range of the diagram will automatically be adapted to the respective peak values. The range will remain as set during the whole measurement.

With **local scaling** the temperature range of the diagram will be adapted dynamically to the respective peak values. After the respective peak has left the diagram in the further process of the measurement, the range will be readapted. This option enables an optimum display of the temperature graph.

A **manual scaling** can be done at any time using the control elements of the temperature axis.

Activation of the desired option:
Control elements (temperature axis) or [Menu: Diagram].

Control elements of the temperature axis:

- | | |
|---|---------------------|
| 1 | Global auto scaling |
| 2 | Local auto scaling |
| 3 | Scroll bar |
| 4 | Zoom in (increase) |
| 5 | Zoom out (decrease) |
| 6 | Whole range |

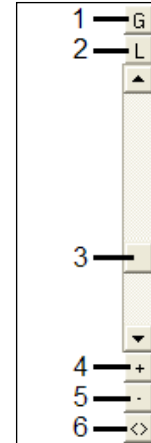
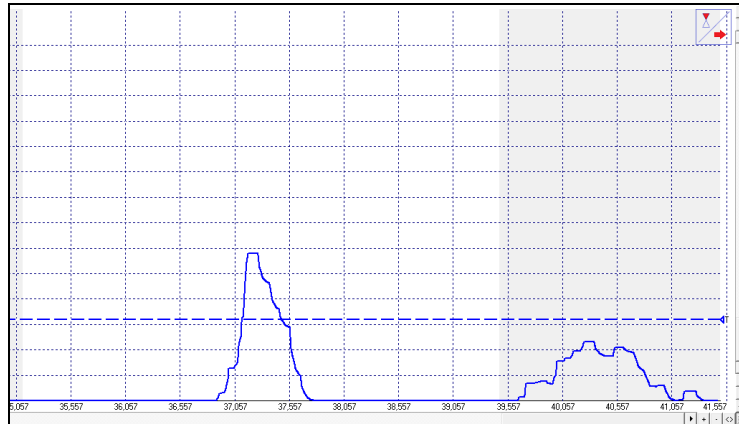
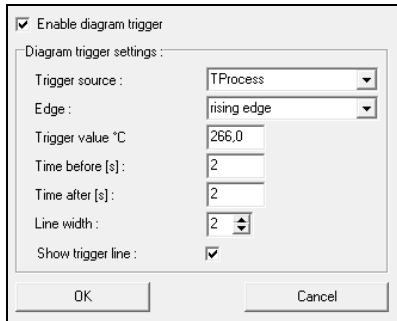

Diagram Compression

With this function you can activate an automatic on-hold of the diagram update and recording via a temperature threshold. In the example below the diagram will only be updated if the process temperature exceeds the threshold value of 266 °C. The made settings also allow a recording of 2 s before and 2 s after the temperature event.



During the on-hold a blinking trigger symbol is shown in the right top corner of the diagram. The allocation of the events to certain process phases is possible without any problem as the real time of the computer will be recorded automatically.

Especially on discontinued processes the amount of data can be reduced with this feature.

Stop Measurement and Save Data

To stop the current measurement please press the **Stop** button [**Menu: Measurement\ Stop**].

The **Save** button [**Menu: File\ Save as**] opens an explorer window to select destination and file name [**file type: *.dat**].

The menu [**Menu: Preferences\ Options**] enables the following settings for data protection:

Options dialog box settings:

- Ask for saving:
- Force data saving after "stop":
- Scan non-USB devices:
- Auto scan device:
- Auto start device:
- Enable button to toggle LASER:
- Warning message if LASER ON:
- Enable button to toggle Video:
- CS rev. 2 - Input monitoring:
- Setup uncommitted value: [button]
- Decimal separator: System, User defined: [text box: .]
- Application title: Application name, User defined: [text box:]
- Temperature unit: °C, °F
- System priority: Priority: normal [dropdown]

Ask for saving¹⁾

If activated, each **Stop** and new **Start** will be followed by the query:
There is unsaved Data. Save now?

Force data saving after „stop“¹⁾

If activated, after each **Stop** an explorer window for saving the data will be opened automatically.

Decimal separator

System uses the computer system based separator for saving the data. If you want to use a **user defined** you can enter the desired separator in the according field.

¹⁾ If none of both options is activated, a new measurement will be started after termination of one measurement and pressing of the **Start** button again. In this case the former data are deleted!

The further options are described under [▶ Basic Settings](#).

Measurement Configuration

With the menu item **[Menu: Measurement\ Settings]** you can define the following parameter for the measurement:

Max. data count

Limitation of the maximum number of data values – when achieved the measurement will be stopped.

Stop/ Overwrite

If the maximum number of data values is achieved, at **Stop** the current measurement will be terminated automatically/ at **Overwrite** the measurement will continue and the first values will be overwritten (principle of ring memory)

Memory

Memory, calculated from the max data count value

Recording interval

Time between single data
[1ms...10s]

Recording time

Maximum time of measurement, calculated from **Max data count** and **Recording interval**

A change of the parameter **Max data count** will have influence on the **Memory** and **Recording time**.

A change of the parameter **Recording interval** will have influence on the **Recording time** only.

Communication mode

At **Auto** setting (recommended) the connected sensor works in **Realtime mode** (=Burst mode: Sensor is sending data continuously) if the recording interval is <200 ms. If the recording interval is >200 ms the sensor works in the **Standard mode** (= Polling mode: Temperature values will be polled by the software).

The current real cycle time will be shown in the status line:

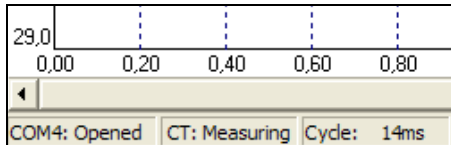

Opening of Files

To open a saved file please press the button **Open** [Menu: File\ Open].

You can select the desired file in an explorer window which will be opened [file type: *.dat].

The temperature files can also be opened and edited with any text editor or with Microsoft Excel.

If you open a file with a spreadsheet program you will find beside the relative time (starting with 000:00:00 – column A) also the absolute time for each measurement value (column N).

On video devices and if the function “Automatic Snapshots” is activated you will find further information to the recorded snapshots in the columns O and P:

	A	B	C	D	E	F	G	H	I	J	K	L	M	N	O	P
1	[Connect DataFile][2.0]															
2	Date:	10.01.2014														
3	Time:	13:49:45														
4	Unit:	°C														
5	Resolution:	0,001/0,100														
6	Values:	11														
7	Time	TObj	Tint	TBox	TAct	T2C	T1C	ATTENUA	Epsilon	mVin	Vcc	TAmb	Compress	Time abs	Imageldx	ImageVal
020	000:00:06,012	268,5	26,6	0	268,5	0	0	0	0	0	0	0	0	13:49:55:063	2014-01-10 - 13-49-54.jpg	268,5
571	000:00:07,563	271,8	26,6	0	271,8	0	0	0	0	0	0	0	0	13:49:56:614	2014-01-10 - 13-49-56.jpg	271,8
8739	000:00:12,731	267,7	26,7	0	267,7	0	0	0	0	0	0	0	0	13:50:13:306	2014-01-10 - 13-50-13.jpg	267,7

Sensor Setup CT/ CTlaser/ CTvideo – Signal Processing

The button **Setup** [Menu: Device\ Device Setup] opens a window for the setting of all sensor parameters.

The dialog window is separated into 3 categories:

- Signal processing Emissivity, Transmissivity, Tamb compensation, Post processing
- Output signals Output channels and Alarm settings
- Advanced settings Head parameter, Device adjustment, Multidrop address, Lock of programming keys, Temperature unit

The screenshot shows the 'Signal processing' tab of the sensor setup dialog. At the top, it displays 'Serial No.: 6080336' and 'Firmware Rev.: 42'. Below this are three tabs: 'Signal processing' (selected), 'Output signals', and 'Advanced settings'. The main area is divided into three columns: 'Emissivity / Transmissivity', 'Ambient control', and 'Post processing'.
- **Emissivity / Transmissivity:** 'Emiss. mode' is set to 'Fixed value'. 'Emissivity' is 0,950. There is an 'Edit material table' button. 'Transmissivity' is 1,000.
- **Ambient control:** 'Amb. mode' is 'Internal (Head)'. 'Fixed value' is 300,0. 'Low range temperature' and 'High range temperature' are both 23,7.
- **Post processing:** 'Mode' is 'Averaging'. 'Avg. time [s]' is 0,5. 'Hold time [s]' is 0,0. 'Threshold [°C]' is 0,0. 'Hysteresis [°C]' is 160,0. There is an unchecked checkbox for 'Smart averaging'.
At the bottom, there are buttons for 'Save Config', 'Load Config', 'Cancel', and 'OK'.

Emissivity and Transmissivity

In the selection field **Emiss. mode** in section **Signal processing/ Emissivity, Transmissivity** you can choose between three options to set the emissivity:

Fixed value: The value can be set in the input field **Emissivity**

External: The value is determined by a voltage on the functional input F2.
[0–10 V: 0 V ► $\varepsilon=0,1$ | 9 V ► $\varepsilon=1,0$ | 10 V ► $\varepsilon=1,1$]

Table: Input of up to eight different emissivity values and corresponding alarm values A and B in a **Material Table**. A combination of low and high values on the functional inputs F1 to F3 selects the different table values.

A non connected input represents: F1=High | F2, F3=Low.
[High level: $\geq +3$ V...+36 V | Low level: $\leq +0,4$ V...-36 V]

In the input field **Transmissivity** you have to enter the transmissivity of optional optical components like an additional lens (CF-optics ACCTCF e.g.) or a protective window (ACCTPW e.g.).

Table entry	F1	F2	F3
0	0	0	0
1	0	0	1
2	0	1	0
3	0	1	1
4	1	0	0
5	1	0	1
6	1	1	0
7	1	1	1

Signal processing
Output signals

Emissivity / Transmissivity

Emiss. mode: Fixed value

Emissivity: 0,950

Edit material table

Transmissivity: 1,000

Material Table

After selection of **Table** in the field **Emiss. mode** you can press the button **Edit material table**.

You can now preset the emissivity values for up to 8 different materials. Thereto you have to set the cursor in the respective field of the table.

Two alarms (A and B) can be allocated for each material/ emissivity value. For the output of the alarm the following selection is possible:

- Alarm 1 (blue)
- Alarm 2 (red)
- Output channel 1
- Output channel 2
- <none>

	Eps.	Alarm A Value	Alarm A output to	Alarm B Value	Alarm B output to
0	0.650	105.0	Alarm 1 (blue)	300,0°C	Alarm 2 (red)
1	0.830	200,0°C	Alarm 2 (red)	71,0°C	Alarm 1 (blue)
2	0.945	185,0°C	output channel 1	65,0°C	<none>
3	0.920	87,0°C	output channel 2	-20,0°C	Alarm 1 (blue)
4	0.800	310,0°C	Alarm 2 (red)	0,0°C	<none>
5	0.680	155,0°C	Alarm 1 (blue)	200,0°C	Alarm 2 (red)
6	0.770	38,5°C	Alarm 1 (blue)	55,0°C	Alarm 2 (red)
7	0.960	620,0°C	Alarm 1 (blue)	700,0°C	Alarm 2 (red)

Set all:

OK Cancel

Output channel 1 and 2 can only be selected if they are defined as digital (section **Output signals**) before.

Other properties like normally open/ close and source (the source of output channel 1 [TObj] cannot be changed) have to be defined in section **Output signals** too.

The selection of **Set all** (below the columns) will cause a take over of an entered value for all fields of the according column.

Ambient Temperature Compensation

In dependence on the emissivity value of the object a certain amount of ambient radiation will be reflected from the object surface. To compensate this impact, the software provides the feature **Ambient control**:

- **Internal (Head):** The ambient temperature will be taken from the head-internal Pt1000 probe (factory default setting).
- **External:** The ambient temperature will be determined by a voltage on the functional input-pin F3 **[0 – 10 V ► -40 – 900 °C; range scalable]**. With an external probe or with a second CT a real-time ambient temperature compensation can be realized.
- **Fixed value:** A fixed value can be entered in the edit box **Fixed value** (if the ambient radiation is constant).

Especially if there is a big difference between the ambient temperature at the object and head temperature the use of Ambient control with **External input** or **Fixed value** is recommended.

Advanced settings |

Ambient control

Amb. mode: Internal (Head) ▼

Fixed value: 300.0 ▼

Low range temperature: 23.7 ▼

High range temperature: 23.7 ▼

Post Processing

In section **Signal processing/ Post processing** you can select the following functions:

- Averaging
- Peak hold
- Valley hold
- Adv. peak hold
- Adv. valley hold
- Off

Averaging

In this mode an arithmetic algorithm will be performed to smoothen the signal. The **Avg. time** is the time constant. This function can be combined with all other post processing functions. The minimum adjustable average time is 0,1s; on the models 1M, 2M and 3M 1ms (0,001s). On these models values below 0,1s can be increased/ decreased only by values of the power series of 2 (0,002, 0,004, 0,008, 0,016, 0,032, ...).

Peak hold

In this mode the sensor is waiting for descending signals. If the signal descends the algorithm maintains the previous signal peak for the specified **Hold time**. The minimum adjustable hold time is 0,1s; on the models 1M, 2M and 3M 1ms (0,001s).

After the hold time the signal will drop down to the second highest value or will descend by 1/8 of the difference between the previous peak and the minimum value during the hold time. This value will be held again for the specified time.

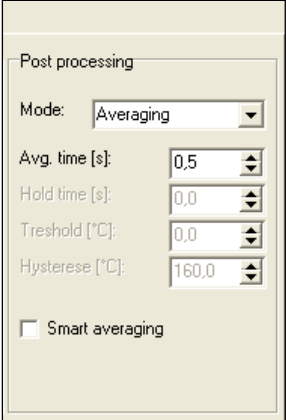

The screenshot shows a configuration window titled "Post processing". It contains the following settings:

- Mode: Averaging (selected in a dropdown menu)
- Avg. time [s]: 0,5 (spin button)
- Hold time [s]: 0,0 (spin button)
- Threshold [°C]: 0,0 (spin button)
- Hysteresis [°C]: 160,0 (spin button)
- Smart averaging: (checkbox)

After this the signal will drop down with slow time constant and will follow the current object temperature.

► Signal Graphs

Therefore, if periodic events will be measured (bottles on a conveyor e.g.) this peak hold function avoids a drop down of the signal to the conveyor temperature in-between 2 events.

Valley hold

In this mode the sensor waits for ascending signals. If the signal ascends the algorithm maintains the previous signal valley for the specified **Hold time**. The definition of the algorithm is according to the peak hold algorithm (inverted).

Advanced Peak hold

In this mode the sensor waits for local peak values. Peak values which are lower than their predecessors will only be taken over if the temperature has fallen below the **Threshold** value beforehand. If **Hysteresis** is activated a peak in addition must decrease by the value of the hysteresis before the algorithm takes it as a new peak value.

Advanced Valley hold

This mode is the inverted function of Advanced Peak hold. The sensor waits for local minima. Minimum values which are higher than their predecessors will only be taken over if the temperature has exceeded the **Threshold** value beforehand. If **Hysteresis** is activated a minima in addition must increase by the value of the hysteresis before the algorithm takes it as a new minimum value.

Peak picking function [1M/ 2M/ 3M only]

In order to detect fast events which are shorter than 1ms you have to set the **Avg. time** to 0,0s and activate the **Peak hold** function. In this mode the sampling rate is 250 μ s.

You can display the object temperature **TProcess** (with post processing) and also the current object temperature **TActual** (without any post processing) in the diagram. In this way the result and functionality of the selected post processing features can easily be traced and controlled.

Smart Averaging

If activated, a dynamic average adaptation at high signal edges is active.

If **Off** is activated, no post processing will happen ($T_{Process} = T_{Actual}$).

Signal Graphs

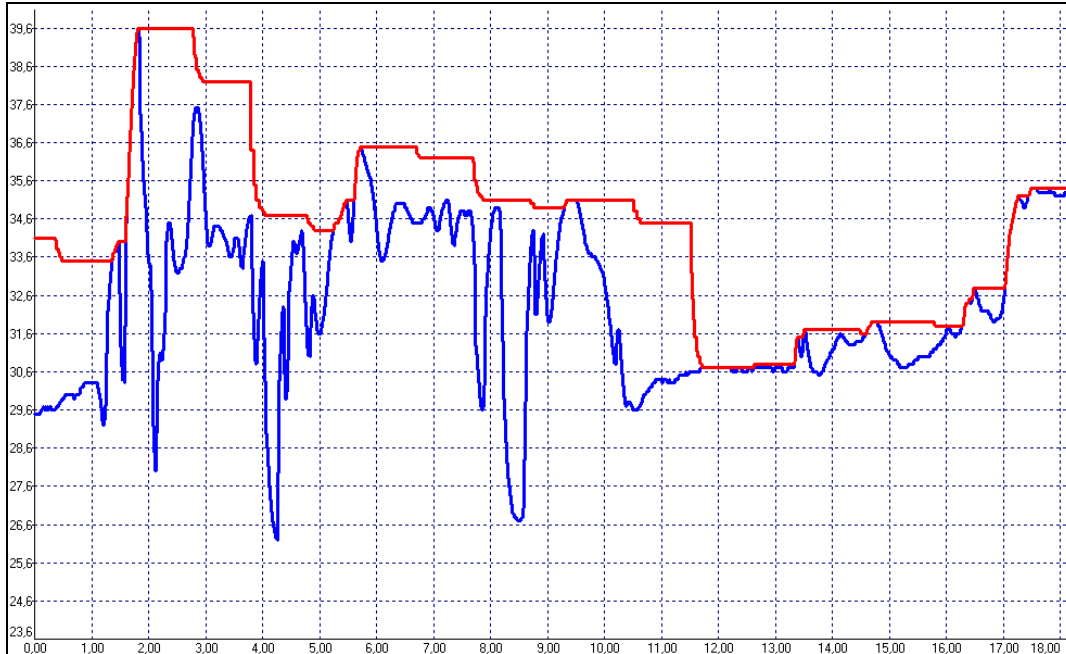

- TProcess with Peak Hold (Hold time = 1s)
- Actual without post processing

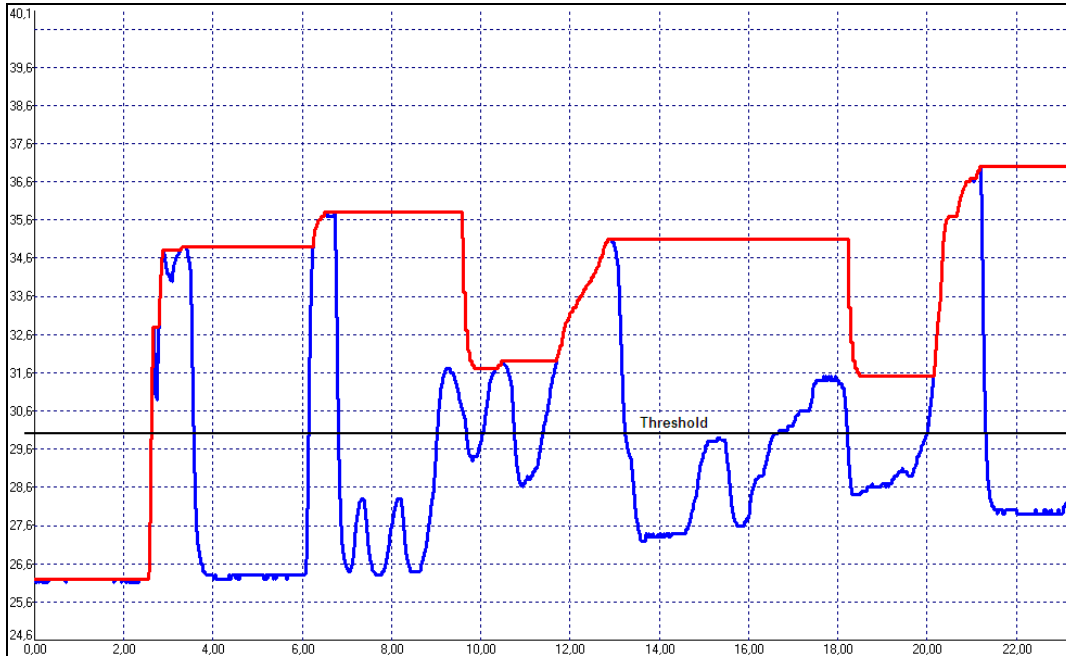

- TProcess with Advanced peak hold (Threshold = 30 °C/ Hysteresis = 1 °C)
- TActual without post processing

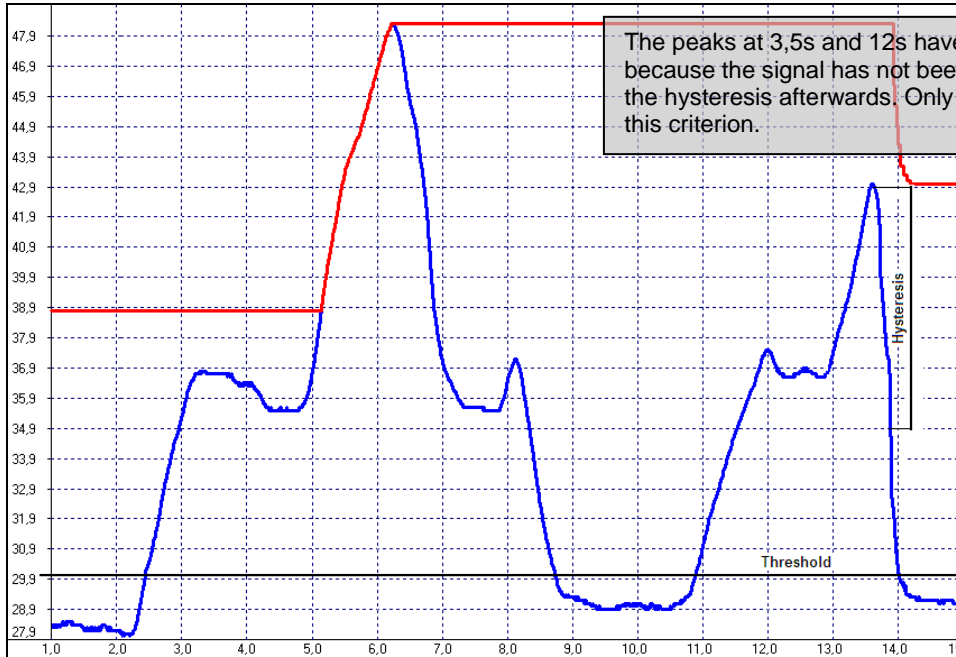

- TProcess with Advanced peak hold (Threshold = 30 °C/ Hysteresis = 8 °C)
- Actual without post processing

Sensor Setup CT/ CTlaser/ CTvideo – Output Signals

You can set up the **Output channels 1 and 2** and the **Visual alarms** in section **Output signals**.

Serial No.: 9030239 Firmware Rev.: 1028

Signal processing | **Output signals** | Advanced settings

Output channel 1 (TProc.):

Mode: digital analog

Normally: open closed

Output: Mode: 0.5V

Connect your hardware to pin: **OUT-mV/mA**

Adjust output slope

Alarm [°C]: 80,0

Output channel 2 (THead):

Mode: digital analog

Normally: open closed

Range: 0.10V 0.5V

Source: THead

Alarm [°C]: 60,0

Visual alarms:

Alarm 1 30,0

Alarm 2 100,0

Normally: open closed

Source: TProces

Presets: Blue Backlight, Standard visual alarms

Save Config Load Config Cancel OK

Overview Alarm outputs

- **Output channel 1 and 2** if Mode is set to digital
- **Visual alarms**
 - = color alarms in the LCD display
 - = alarms of the optional relays interface
 - = AL2 output (open collector/ only Alarm 2)

Output Channel 1

The output channel 1 is used for output of the object temperature **TProcess**.

If **analog** is activated the following analog output signals are available in the selection field **Output: Mode**:

- 0-5 V
- 0-10 V
- 0/4-20 mA
- Thermocouple (t/c J or t/c K)

After you have selected the desired output you can adjust the temperature range of the sensor by pressing the button **Adjust output slope**. The range limits can either be entered directly in the input fields or by shifting the output function graph (by catching the points **Low** or **High** with the cursor).

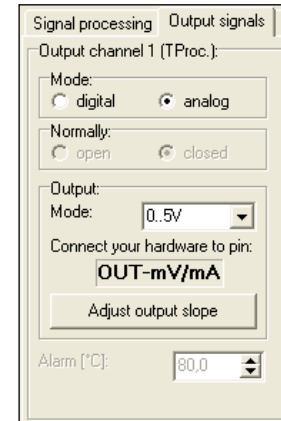
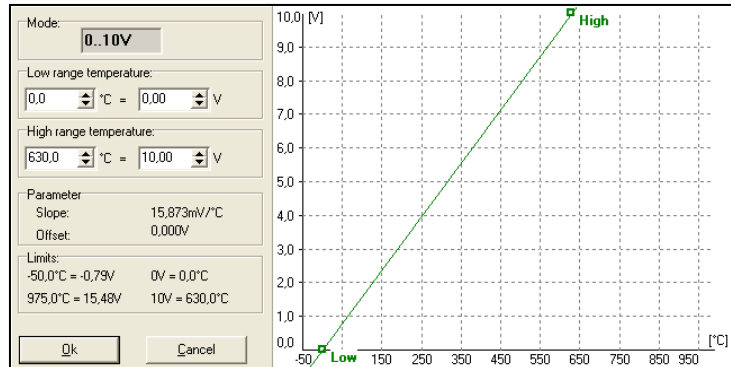

Alternatively the output channel 1 can also be used as an alarm output. Thereto you have to choose the mode **digital**. The selection **Normally open/ closed** defines the output as High or Low alarm.

Please enter the alarm value (threshold) in the input field **Alarm**.

The selected output signal (0-5 V/ 0-10V/ 0-20 mA/ 4-20 mA) is also valid if the channel is used as alarm output. Dependend on the alarm status either the lower or the upper range limit value will be given out.

Output Channel 2 [LT/ G5/ P7 only]

This channel is normally used as output for the head temperature **THead** (Analog mode preset). The output signal is 0-5 V or 0-10 V [according -20...180 °C or -20...250 °C on CHot models].

Alternatively the output channel 2 can also be used as an alarm output. For this you have to choose the mode **digital**. The selection **Normally open/ closed** defines the output as High or Low alarm.

In the selection field **Source** the alarm signal source can be selected between **TObj**, **THead** and **TBox**.

Please enter the alarm value (threshold) in the input field **Alarm**.

The output can be selected between 0-5 V and 0-10V.

Dependent on the alarm status either the lower or the upper range limit value will be given out.

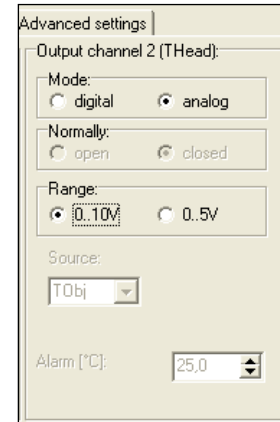

Advanced settings

Output channel 2 (THead):

Mode:

digital analog

Normally:

open closed

Range:

0..10V 0..5V

Source:

TObj

Alarm [°C]: 25,0

Visual Alarms

The **Alarms 1 and 2** (Visual Alarms) will cause a change of the backlight color of the LCD display of the electronic box and in addition they are available via the optional relay interface. In addition the Alarm 2 can be used as open collector output on pin **AL2** at the CT electronics (24V/ 50mA).

Also here the selection **Normally open/ closed** defines the alarm as High or Low alarm.

In the selection field **Source** the alarm signal source can be selected between **TProcess**, **THead** and **TBox**. Both alarms will cause the following color change of the LCD display:

- blue: alarm 1 active
- red: alarm 2 active
- green: no alarm active

The standard mode for the visualization of the alarms can be reset with the button

Standard visual alarms.

The button **Blue Backlight** is a presetting to achieve a permanent blue backlight on the LCD display.

All alarms (Alarm 1, Alarm 2, Output channel 1 and 2 if used as alarm output) have a fixed hysteresis of 2 K (CThot: 1K).

The screenshot shows a configuration window for 'Visual alarms'. It is divided into two columns for 'Alarm 1' and 'Alarm 2'. Each column has a numerical input field (30,0 for Alarm 1, 100,0 for Alarm 2), a 'Normally:' section with radio buttons for 'open' and 'closed' (both are selected), and a 'Source:' dropdown menu set to 'TProces'. Below these columns is a 'Presets:' section with two buttons: 'Blue Backlight' and 'Standard visual alarms'.

On the models 1M, 2M and 3M the hysteresis at Alarm 2 can be adjusted in addition:

Visual alarms:

Alarm 1	Alarm 2
800,0	1400,0
Normally: <input type="radio"/> open <input checked="" type="radio"/> closed	Normally: <input checked="" type="radio"/> open <input type="radio"/> closed
Source: TProcess	Source: TProcess
	Hysteresis : 0,0

Sensor Setup CT/ CTlaser – Advanced Settings

In section **Advanced settings** the following settings can be made:

- Head parameter
- Device adjustment
- Multidrop address
- Lock/ Unlock of programming keys
- Temperature unit

The screenshot shows the 'Advanced settings' tab of the CompactConnect software interface. At the top, it displays 'Serial No.: 7030242' and 'Firmware Rev.: 42'. The 'Advanced settings' tab is selected, showing three main sections: 'Head parameter', 'Device adjustment', and 'Multidrop address'. The 'Head parameter' section contains three input fields with the values 'F4JG', '62KF', and '0HB4', and a 'Change head parameter' button below them. The 'Device adjustment' section has 'Offset: 0.0' and 'Gain: 1,000' with spinners, and a 'Reset Offset/Gain' button. The 'Multidrop address' section has a 'Multidrop address: 1' spinner and a warning message: 'Changing the address takes effect after closing this dialog. Check fixed address in interface setup!'. Below these sections is the 'User Interface' section with an 'Unlocked' button and a 'Temperature unit' section with radio buttons for '°C' (selected) and '°F'. At the bottom, there are buttons for 'Save Config', 'Load Config', 'Cancel', and 'OK'.

Serial No.: 7030242	Firmware Rev.: 42	
Signal processing	Output signals	Advanced settings
Head parameter	Device adjustment	Multidrop address
F4JG 62KF 0HB4	Offset: 0.0 Gain: 1,000	Multidrop address: 1
Change head parameter	Reset Offset/Gain	Changing the address takes effect after closing this dialog. Check fixed address in interface setup!
User Interface	Temperature unit	
Unlocked	<input checked="" type="radio"/> °C <input type="radio"/> °F	
Save Config	Cancel	OK
Load Config		

Head Parameter

With exception of the CTfast (LT15F/ LT25F) an exchange of sensing heads and electronics on all models of the CT- and CTlaser-series is possible.

The 3x4-digit code (resp. 5x4-digit code) contains the calibration data of the head. For a correct temperature measurement it is necessary, that the sensing head code (labeled on each head or head cable) is matching the entered code in the corresponding electronic box.

From the factory side this has been done already – a change of the setting by pressing the button **Change head parameter** is only necessary, if the head will be exchanged.

Lock Programming Keys

With this function you can lock the programming keys on the CT electronics to avoid a non authorized change of parameters on the unit. Pressing the button will set the unit into the **locked** or **unlocked** mode.

In the locked mode all parameter and settings can be displayed on the unit by pressing the **Mode** button – a change of parameters with the **Up** or **Down** button is not possible.

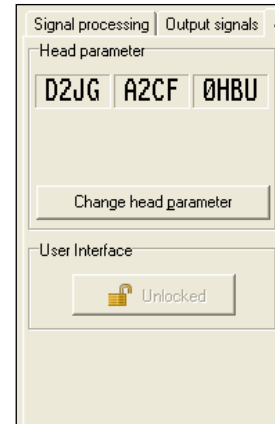

Device Adjustment

For certain applications or under certain circumstances a temperature offset or a change of the gain for the temperature curve may be useful.

The factory default settings for Offset and Gain are:

- Offset: 0,0 K
- Gain: 1,000

A changed **Offset** causes a parallel shifting of the temperature curve and therewith it has a linear effect on the temperature reading (change constant independent on object temperature). A change of the **Gain** will have a non-linear effect on the temperature reading (change depends on object temperature).

Temperature unit

Selection between °C and °F as temperature unit.

RS485 Multidrop Address

In combination with a RS485 interface you can build a network of several CT sensors (max. 32 sensors).

For the digital communication each sensor must have its own address which you can enter in the input field Multidrop address.

► RS485/ RS422

The screenshot shows the 'Advanced settings' dialog box for the CompactConnect device. At the top, it displays 'Firmware Rev.: 42'. The dialog is divided into several sections:

- Device adjustment:** Contains two spinners for 'Offset' (set to 0,0) and 'Gain' (set to 1,000). Below them is a button labeled 'Reset Offset/Gain'.
- Multidrop address:** Contains a spinner for 'Multidrop address' (set to 1). Below it is a note: 'Changing the address takes effect after closing this dialog. Check fixed address in interface setup!'.
- Temperature unit:** Contains two radio buttons: '°C' (which is selected) and '°F'.

Video Settings

If a CTvideo or CSvideo is connected you will see the live video picture automatically in the right part of the software window. With the button **Video** [Menu: **View\enable Video**] you can switch on and off the video display.

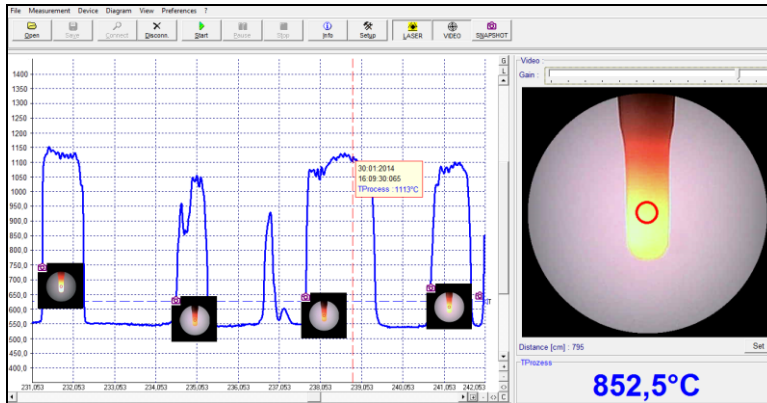

The Video Settings dialog box contains the following controls:

- Red: 1,00
- Green: 1,00
- Blue: 1,00
- Brightness: 1,00
- Rotation angle: 0
- Gain: 180
- Black and White:
- Mirror-X:
- Mirror-Y:
- Anti flicker mode: Off
- Target circle: Width: 5, Style: Solid, Color: Red
- Background: Background color: Black, BG Circle Diameter: 650, Background circle color: Black
- Buttons: OK, Standard

The location and size of the measurement spot is shown in the video picture. This enables an exactly positioning of the sensor to the target.

With the right mouse button you can open **Setup Videodisplay** (if the cursor is placed on the video display).

The following settings can be made here:

Red/ Green/ Blue:	Gain setting for the different color channels
Brightness:	Setup of brightness
Rotation angle ¹⁾ :	Stepless rotation of the video picture for a correct display of the measurement object independent on the installation position of the sensor
Gain ²⁾ :	Setup of gain – in combination with brightness adaptation to different luminosities of objects
Black and White:	Switch to b/w video display
Mirror-X:	Picture mirroring in x axis
Mirror-Y:	Picture mirroring in y axis
Anti flicker mode:	Filter for a suppression of 50Hz or 60Hz flickering
Target circle:	Setup of line Width, Style (Solid, Dotted line) and Color of the spot marking
Background:	Setup of the colors for background, circle background and circle diameter – with this parameter you can adjust the magnification of the video display.

¹⁾ The display rotation can also be done outside this dialog: with the left mouse button you can grab the picture and rotate it by moving the mouse to the left or to the right side.

²⁾ The slider for gain is in addition also available right on top of the video picture.

Underneath the video picture you will find a field for input of the measurement distance. Please enter here by pushing the **Set** button the distance sensor – object after you did the focusing of the optics:

Distance [cm] : 795	Set
---------------------	-----

The settings are stored for the connected sensor and kept also after software termination.

With the **Standard** button the factory default setting can be easily restored.

Video Snapshots

With the software you can make manually or automatically triggered snapshots.

Beside the picture you can display additional information which is stored inside the snapshot file:

{TAB}	TAB	tabulator
{DATE}	DATE	current date
{TIME}	TIME	current time
{TPRO}	TPRO	T _{Process} Process temperature
{TACT}	TACT	T _{actual} current object temperature without signal processing
{TAMB}	TBOX	T _{Box} temperature of the electronic box (CTvideo)
{TBOX}	TINT	T _{int} internal sensor temperature
{TINT}	SERNO	serial number
{SERNO}	RANGE	measurement range
{RANGE}	FWREV	revision of the sensor firmware
{FWREV}	DEV	sensor type
{DEV}	COMPANY	manufacturer (information taken from the corporate.ini file)
{COMPANY}		

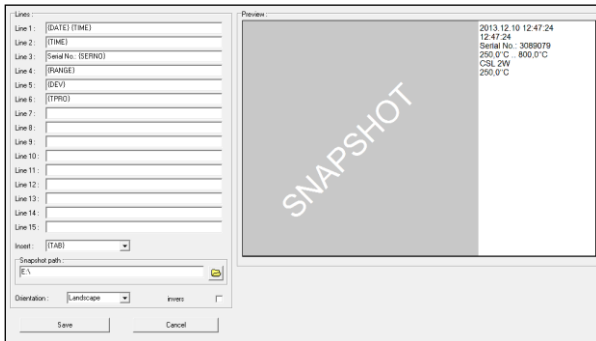

You can open the snapshot configuration under **[Menu: Preferences\ Video snapshot setup]**.

Each line (1-15) can contain a combination of free text and data fields. To insert a field please click into the according line and select the field under **Insert**.

With **invert** white letters on black background can be displayed.

You can define the location for saving a snapshot under **Snapshot path**.

If you press the button **Snapshot** [Menu: **View\ Video snapshot**] a picture will be stored.

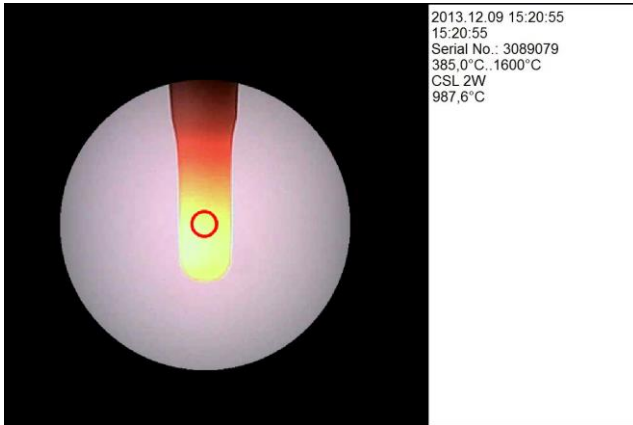

Example for a snapshot

Automatic Snapshots

You can make automatic snapshots which are either time triggered (fixed interval) or temperature triggered (Threshold). Please open [**Menu: Measurement\ Automatic snapshot**]. After activation you can select under **Trigger source** different temperature signals (TProcess, Tint, TBox, TActual) or **Time** for a time triggered recording.

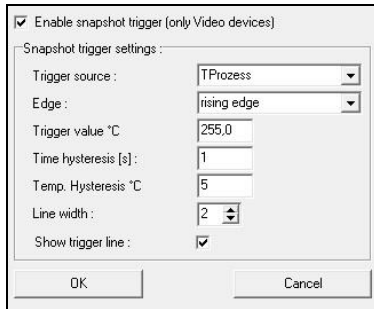

Edge	Snapshot triggering on rising or falling signal edge
Time hysteresis	Minimum gap between two snapshots
Temp. Hysteresis	Snapshot will be triggered only if the signal drops by the value of the hysteresis under the threshold (rising edge) or over the threshold (falling edge)
Line width	Line width of the trigger line if shown in the diagram (Show trigger line activated)

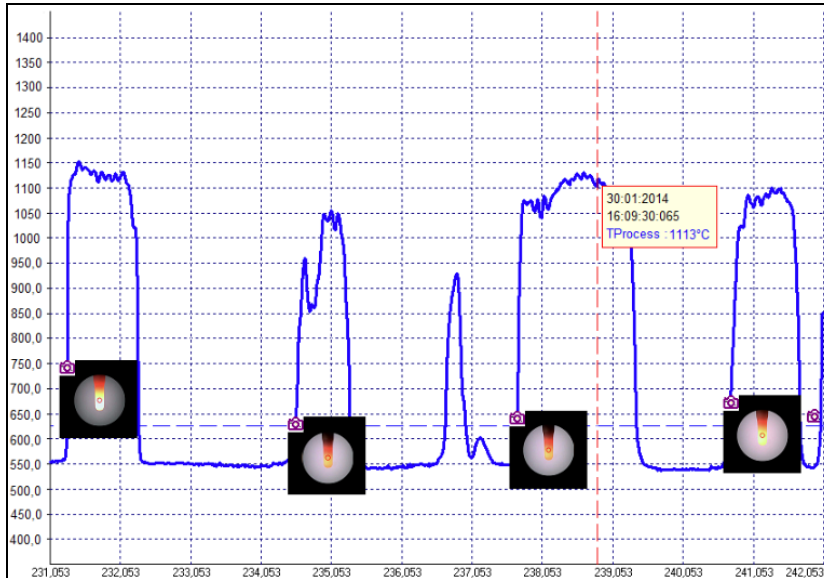

Temperature-Time-Diagram with automatic snapshots – a mouse click on the camera icon opens a thumbnail of the according picture; double click opens the snapshot in full screen.

If you save the diagram as *.dat file all related pictures will be saved automatically in a folder which is located in the same directory and which has the same name as the dat-file.

Sensor Setup CTratio – Output Signals

The button **Setup** [Menu: Device\ Device Setup] opens a window for the setting of all sensor parameters.

The dialog window is separated into 4 categories:

- Output signals Setting of Output channel 1 and Digital I/O pins
- Signal processing Setting of Emissivity/ Slope and Post processing
- Visual alarms Display main value and Backlight/ Alarm setting
- Advanced settings Device adjustment, Multidrop address, Lock of programming keys, Temperature unit

Serial No.: 7101001 Firmware Rev.: 5003

Output signals | Signal processing | Visual alarms | **Advanced settings**

Output channel 1 (TProcess):

Source : T_2C

Output:
Mode: 0.5V

Connect your hardware
to pin:

OUT-mV/mA

Adjust output slope

Digital I/O:

Dig. I/O 1 Dig. I/O 2

Function: Function:

[Dig. Alarm] [Dig. Alarm]

Source: Source:

[Attenuation] [T_2C]

Value: [%] Value: [°C]

99.0 1000.0

Normally: Normally:

open open

closed closed

"I/O 1" acts as : "I/O 2" acts as :

OUTPUT **OUTPUT**

Save Config Cancel

Load Config OK

Output Channel 1

The output channel 1 is used for output of the object temperature **TProcess**.

The following signal sources are available in the selection field **Source**:

- T 2C 2C temperature
- T 1C 1C temperature
- Attenuation Signal attenuation in %

The following analog output signals are available in the selection field **Output: Mode**:

- 0-5 V
- 0-10 V
- 0/4-20 mA

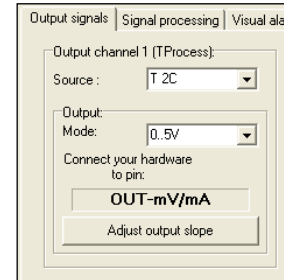
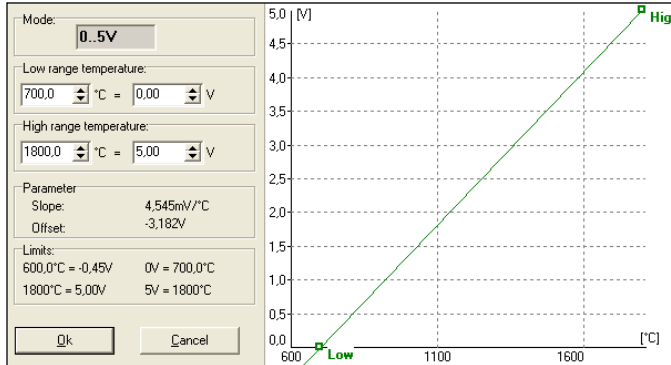

After selection of the desired output you can adjust the temperature range of the sensor by pressing the

button **Adjust output slope**. The range limits can either be entered directly in the input fields or by shifting the output function graph (by catching the points **Low** or **High** with the cursor).



I/O pins

The CTratio has two I/O pins which can be programmed as in- or outputs using the software. The following options are available:

Function	I/O pin acts as	Description
Digital Alarm	output (dig.)	Open collector output/ definition as HIGH- or LOW alarm via norm. open/ norm. close options in software dialog.
Valid LO	input (dig.)	The output follows the object temperature as long as there is a Low level at the I/O pin. After discontinuation of the Low level the last value will be held.
Valid HI	input (dig.)	The output follows the object temperature as long as there is a High level at the I/O pin. After discontinuation of the High level the last value will be held.
Hold 	input (dig.)	The last value will be held if there is a signal with a rising edge on the I/O pin.
Hold 	input (dig.)	The last value will be held if there is a signal with a falling edge on the I/O pin
Slope external	input (analog)	External adjustment of the slope value using an analog voltage (0-10 V)
Emiss. external	input (analog)	External adjustment of the emissivity value using an analog voltage (0-10 V)
Hold Reset LO	input (digital)	Reset of a hold function on a Low level at the I/O pin
Hold Reset HI	input (digital)	Reset of a hold function on a High level at the I/O pin

High-Pegel: > 0,8 V

Low-Pegel: < 0,8 V

If you select the function **Digital Alarm** the following signal sources can be selected:

T_2C	Temperature value 2-color-mode
T_1C	Temperature value 1-color-mode
Attenuation	Signal attenuation in %
TBox	Temperature of the electronics
TProcess	Signal which was selected for Output channel 1

The definition as Low or High alarm can be done by switching between **Normally: open** and **Normally: closed**.

Digital I/O:

Dig. I/O 1	Dig. I/O 2
Function: Dig. Alarm	Function: Dig. Alarm
Source: Attenuation	Source: T_2C
Value: [%] 99,0	Value: [°C] 1000,0
Normally: <input type="radio"/> open <input checked="" type="radio"/> closed	Normally: <input checked="" type="radio"/> open <input type="radio"/> closed
"I/O 1" acts as: OUTPUT	"I/O 2" acts as: OUTPUT

If you select the function **ext. Slope** or **ext. Emiss.** the I/O pin is set as analog input. The scaling can be done using the input fields Slope@ 0V (Emiss.@ 0V) or Slope@ 10V (Emiss.@ 10V).

Digital I/O:

Dig. I/O 1	Dig. I/O 2
Function: Slope external	Function: Dig. Alarm
Source: Slope @ 0V	Source: T_2C
Slope @ 0V 0,800	Value: [°C] 1000,0
Slope @ 10V 1,200	
Current value: 0,800	Normally: <input checked="" type="radio"/> open <input type="radio"/> closed
"I/O 1" acts as: INPUT	"I/O 2" acts as: OUTPUT

If you select the function **Hold Reset LO** or **Hold Reset HI** the I/O-Pin is set as digital input. An activated hold function (MAX, MIN, advanced MAX, advanced MIN) will be reset if a low or high level is at the I/O pin.

The screenshot shows a configuration window titled "Digital I/O:". It is divided into two columns for "Dig. I/O 1" and "Dig. I/O 2".

- Dig. I/O 1:** The "Function:" dropdown is set to "Hold Reset LO".
- Dig. I/O 2:** The "Function:" dropdown is set to "Dig. Alarm". The "Source:" dropdown is set to "T_2C". The "Value : [°C]:" is set to "1000.0". Under "Normally:", the "open" radio button is selected.

At the bottom of the window, there are two buttons: "I/O 1" acts as: **INPUT** and "I/O 2" acts as: **OUTPUT**.

Sensor Setup CTratio – Signal Processing

In this category you can adjust the parameters **Emissivity**, **Slope**, **Attenuation** and select the functions and define the parameters for **Signal processing**.

Serial No.:	7101001	Firmware Rev.:	5003
Output signals: Signal processing Visual alarms Advanced settings			
Emissivity/Slope		Post processing (TProcess)	
Slope:	<input type="text" value="1,000"/>	2C Temp. : [°C]:	<input type="text" value="700,0"/>
Emissivity:	<input type="text" value="1,000"/>	1C Temp. : [°C]:	<input type="text" value="600,0"/>
max. Attenuation:	<input type="text" value="95,0"/>		
		Source:	T 2C
		Mode:	Peak hold
		Avg. time [s]:	<input type="text" value="0,20"/>
		Hold time [s]:	<input type="text" value="0,5"/>
		Threshold [°C]:	<input type="text" value="65,0"/>
		Hysteresis [°C]:	<input type="text" value="10,0"/>
		<input checked="" type="checkbox"/> Smart averaging	
		min. difference [°C]:	<input type="text" value="5,0"/>
<input type="button" value="Save Config"/>		<input type="button" value="Cancel"/>	
<input type="button" value="Load Config"/>		<input type="button" value="OK"/>	

Emissivity/ Slope/ Attenuation

The **Emissivity** (ϵ – Epsilon) is a material constant factor to describe the ability of a body to emit infrared energy. The emissivity only affects measurements in the 1-color-mode.

The **Slope** is the quotient of the emissivities of both of the overlapping wavelengths and therewith the deciding parameter for measurements in 2-color-mode.

Attenuation : The temperature measurement will stop if the attenuation exceeds this limit.

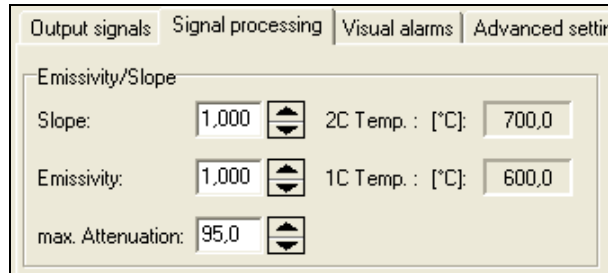

The screenshot shows a software interface with four tabs: 'Output signals', 'Signal processing', 'Visual alarms', and 'Advanced settings'. The 'Advanced settings' tab is active. Under the heading 'Emissivity/Slope', there are three rows of controls:

- 'Slope:' with a numeric input field containing '1,000' and a vertical arrow button.
- '2C Temp. : [°C]:' with a numeric input field containing '700,0'.
- 'Emissivity:' with a numeric input field containing '1,000' and a vertical arrow button.
- '1C Temp. : [°C]:' with a numeric input field containing '600,0'.
- 'max. Attenuation:' with a numeric input field containing '95,0' and a vertical arrow button.

To use the full range up to 1800 °C in the 1-color-mode the attenuation has to be limited to **50%**.

NOTE: By clicking at the button beside the dialog box (increase value/ decrease value) and simultaneous movement of the mouse upwards or downwards the values will be changed continuously. Dependent on the distance of the cursor from the initially position the color of the arrow button will change and also the speed of value increasing/ decreasing.



A close-up of the 'Slope' control from the dialog box. It consists of a text label 'Slope:', a numeric input field containing the value '1,200', and a blue upward-pointing arrow button.

Post Processing

In the category Signal processing/ Post processing you can select the following functions:

- Average
- Peak hold
- Valley hold
- Advanced Peak hold
- Advanced Valley hold
- Off

You will find the description of the single functions under ► **Post Processing**. The field **Source** shows the output signal (= TProcess) which has been selected in the category **Output signals**.

Smart Averaging

If activated, a dynamic average adaptation at high signal edges is active. In addition you can enter the minimum temperature difference (**min. difference**) to trigger this function.

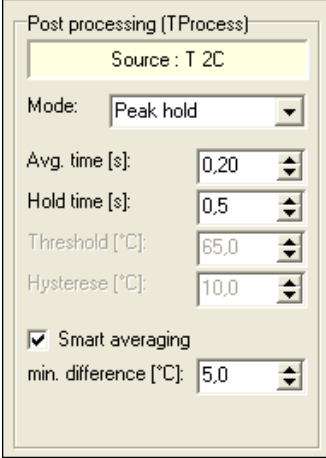

The image shows a configuration dialog box titled "Post processing (TProcess)". The "Source" is set to "T 2C". The "Mode" is set to "Peak hold". The "Avg. time [s]" is 0,20, "Hold time [s]" is 0,5, "Threshold [°C]" is 65,0, and "Hysteresis [°C]" is 10,0. The "Smart averaging" checkbox is checked, and the "min. difference [°C]" is set to 5,0.

Parameter	Value
Source	T 2C
Mode	Peak hold
Avg. time [s]	0,20
Hold time [s]	0,5
Threshold [°C]	65,0
Hysteresis [°C]	10,0
Smart averaging	<input checked="" type="checkbox"/>
min. difference [°C]	5,0

Sensor Setup CTratio – Visual Alarms

In this category you can make settings regarding **display** and **LCD backlight** (= visual alarms). Basically you can select between the two modes **Ranges** and **Threshold**.

Independent on the selected signal for the analog output you can select a signal (**Display main value/Source**) out of the following listing, which will be displayed on the LCD of the electronics:

T_2C	Temperature value 2-color-mode
T_1C	Temperature value 1-color-mode
Attenuation	Signal attenuation in %
TBox	Temperature of the electronics
TProcess	Signal which was selected for Output channel 1

In the **Threshold** mode only two values can be entered (for **blue** and **red**).

In the **Ranges** mode at **Backlight settings** one signal can be allocated to up to eight alarm limits. The selected signal (under **Source**) can be selected independently from the signal shown in the display and independently from the analog output.

By combining the different colors up to seven different backlight conditions can be realized.

Serial No.: 2096538 Firmware Rev.: 5019

Output signals | Signal processing | Visual alarms | Advanced settings

Display main value :
Source : T_2C

Backlight alarm mode :
 Ranges Threshold

Backlight settings :
Source : T Process

from	to	Blue	Green	Red
700.0 [°C]	900.0 [°C]	<input checked="" type="checkbox"/>	<input type="checkbox"/>	<input checked="" type="checkbox"/>
900.0 [°C]	1000.0 [°C]	<input type="checkbox"/>	<input checked="" type="checkbox"/>	<input type="checkbox"/>
1000.0 [°C]	1800.0 [°C]	<input type="checkbox"/>	<input type="checkbox"/>	<input checked="" type="checkbox"/>
700.0 [°C]	700.0 [°C]	<input type="checkbox"/>	<input type="checkbox"/>	<input type="checkbox"/>
700.0 [°C]	700.0 [°C]	<input type="checkbox"/>	<input type="checkbox"/>	<input type="checkbox"/>
600.0 [°C]	600.0 [°C]	<input type="checkbox"/>	<input type="checkbox"/>	<input type="checkbox"/>
600.0 [°C]	600.0 [°C]	<input type="checkbox"/>	<input type="checkbox"/>	<input type="checkbox"/>
600.0 [°C]	600.0 [°C]	<input type="checkbox"/>	<input type="checkbox"/>	<input type="checkbox"/>

Set display to STANDARD

Save Config Load Config Cancel OK

In dependence on the set ranges the display backlight color will change. If the relay interface is used the color change to **Blue** or to **Red** is also representing the threshold values for the relays:

- Blue** ▶ **Low alarm (Relay 1)**
- Red** ▶ **High alarm (Relay 2)**

The following signals can be selected as source for the display backlight:

T_2C	Temperature value 2-color-mode
T_1C	Temperature value 1-color-mode
Attenuation	Signal attenuation in %
TBox	Temperature of the electronics
TProcess	Signal which was selected for Output channel 1
blue display	
green display	
red display	

The button **Set display to STANDARD** will set the **Display main value** as well as the **Source** for backlight to TProcess and the alarm values back to standard values.

Sensor Setup CTratio – Advanced Settings

In the category **Advanced settings** the following parameter can be adjusted:

- Temperature unit
- Lock/ Unlock of programming keys
- Multidrop address
- Calibration

The screenshot shows the 'Advanced settings' tab of the CompactConnect configuration software. At the top, it displays 'Serial No.: 7101001' and 'Firmware Rev.: 5003'. The 'Advanced settings' tab is selected, showing several configuration options:

- Temp. unit:** Radio buttons for °C (selected) and °F.
- User Interface:** A button with a lock icon and the text 'Unlocked'.
- Multidrop address:** A dropdown menu currently set to '1'. Below it, a note states: 'Changing the address takes effect after closing this dialog. Check fixed address in interface setup!'.
- Calibration:** A section with four spinners: 'Gain 2C: 1,000', '2C Temp.: [°C]: 700,0', 'Gain 1C: 1,000', and '1C Temp.: [°C]: 600,0'.

At the bottom, there are four buttons: 'Save Config', 'Load Config', 'Cancel', and 'OK'.

Lock Programming Keys

With this function you can lock the programming keys on the CTratio electronics to avoid a non authorized change of parameters on the unit. Pressing the button will set the unit into the **locked** or **unlocked** mode. In the locked mode all parameter and settings can be displayed on the unit by pressing the **Mode** button – a change of parameters with the **Up** or **Down** button is not possible.

Temperature unit

Selection between °C and °F as temperature unit.

RS485 Multidrop Address

In combination with a RS485 interface you can build a network of several CTratio sensors (max. 32 sensors). For the digital communication each sensor must have its own address which you can enter in the input field Multidrop address.

► RS485/ RS422

Calibration

You can enter gain factors for the 2C-channel and 1C-channel. Factory default both values are set to 1,000.

Sensor Setup CSLaser/ CSvideo/ CX

The button **Setup** [Menu: Device\ Device Setup] opens a dialog window for set up the parameters of the sensor.

General [CX]

Transmission:	Transmissivity setting
Avg. Time (s):	Average time setting
Smart averaging:	Function for dynamic average adaptation at high signal edges
Emissivity Source:	Fixed value
Emissivity:	Emissivity setting (Fixed value)
Ambient temp. source ¹⁾ :	Selection between Internal (THead) , or Fixed value
Ambient temperature:	Value input for mode Fixed value

General [CSlaser/ CSvideo]

General | mA output | Output | Alarm | Post Processing | Calibration

General setup

Transmission:

Avg. Time [s]: Smart averaging

Emissivity:

Ambient temp. source:

Ambient temperature [°C]:

Emissivity switches:

Enable emissivity switches

Emissivity switches = 0,97

Emissivity = fixed value (0,900)

"IN" pin is configured as

communication input

Transmission:	Transmissivity setting
Avg. Time (s):	Average time setting
Smart averaging:	Function for dynamic average adaptation at high signal edges
Emissivity:	Emissivity setting (Fixed value)
Ambient temp. source ¹⁾ :	Selection between Internal (THead) or Fixed value
Ambient temperature:	Value input for mode Fixed value
Emissivity switches:	Activation or Deactivation of the emissivity switches on the sensor. (CSlaser only)

If the switches are activated the consequent emissivity is the result of the multiplication of the emissivity set on the sensor and the emissivity set in the software.

Emissivity:

Ambient temp. source:

Ambient temperature [°C]:

Emissivity switches:

Enable emissivity switches

Emissivity switches = 0,97

Emissivity = fixed value * switches (0,873)

1) For the compensation of the ambient temperature the internal head temperature is used if Internal (THead) is selected. In dependence on the emissivity value of the object a certain amount of ambient radiation will be reflected from the object surface. Therefore for certain applications it may be useful taking the ambient temperature on the object site for compensation (if significant different from head ambient temperature e.g.).

The following settings can be made:

- **Fixed value:** You can enter a value which represents the ambient radiation in the field **Ambient temp.**

Analog Output (mA)

General | **mA output** | Output | Alarm | Post Processing | Calibration

mA Output :

Temp @ 4mA [°C]:

Temp @ 20mA [°C]:

Failsafe settings :

Headtemp. Failsafe

Temp min: °C mA

Temp max: °C mA

Objecttemp. Failsafe

Temp min: °C mA

Temp max: °C mA

"IN" pin is configured as
communication input

mA output

Temp @ 4 mA: Lower limit temperature range
 Temp @ 20 mA: Upper limit temperature range

Failsafe settings¹⁾: Definition of failsafe modes

If the sensor will be connected to the supply voltage, the unit is checking for the first 300ms if a USB adapter is connected. In this case the bidirectional communication mode will be activated automatically.

¹⁾ The settings for failsafe mode enable a defined level on the analog output in dependence on preset temperature limits for object temperature and/ or sensing head temperature (**Temp min** and **Temp max**).

Digital Output

In the selection field **Mode** you can select between **communication output** (bidirectional digital communication for interaction with the software) and **burst output**.

General | mA output | Output | Alarm | Post Processing | Calibration

Mode:

- communication output
- communication output
- burst output

"IN" pin is configured as
communication input

Save Config | Factory default | Cancel
Load Config | OK

Burst output

Value 1...3:

Selection between:

<none>

Process temperature

Internal temperature

Emissivity

Transmissivity

Ambient temperature

Act. target temperature

In the burst mode the sensor works in a unidirectional communication mode – the sensor is sending data continuously. The burst string can be configured by selection of value 1 to 3.

▶ Command List on software CD]

Open Collector Alarm Output

This function activates an additional alarm output (open collector output) at the **RxD pin (green)**.

The screenshot shows the 'Alarm' configuration window in the CompactConnect software. The window has tabs for 'General', 'Output', 'Alarm', 'PostProcessing', and 'Calibration'. The 'Alarm' tab is active. It features a checked 'Alarm' checkbox, a 'Source' dropdown menu set to 'target temp', a 'Mode' dropdown menu set to 'normally off', and a 'Temp' input field set to '30.0 °C'. Below these fields, a text box indicates that the 'IN' pin is configured as an 'alarm output'. At the bottom, there are buttons for 'Save Config', 'Factory default', 'Cancel', 'Load Config', and 'OK'.

Alarm [open collector]

Source: Selection between:
 Target temperature
 Head temperature

Mode: normally off/ on

Temp.: alarm value

The RxD pin acts as alarm output.
[▶ Sensor manual: Electrical Installation]

Post Processing – Peak/ Valley Hold

General | Output | Alarm | Post Processing | Calibration

Post processing

Hold mode: Peak hold

Hold time [sec]: 1.0

"TIN" pin is configured as
communication input

Save Config | Factory default | Cancel

Load Config | OK

Hold mode:

Selection between:

Off

Peak hold

Valley hold

Advanced peak hold

Advanced valley hold

Peak hold Trigger off

Valley hold Trigger off

Hold time (sec.):

Hold time adjustment

(999,9 = infinite)

In the **Peak hold** mode the sensor is waiting for descending signals. If the signal descends the algorithm maintains the previous signal peak for the specified **Hold time**.

In the **Valley hold** mode the sensor waits for ascending signals. If the signal ascends the algorithm maintains the previous signal valley for the specified **Hold time**.

You will find a detailed description of these functions under **Post Processing**.

Calibration

The screenshot shows the 'Calibration' tab of a software interface. It features two input fields: 'Gain' with a value of 1,000 and 'Offset' with a value of 0,0. Below these fields, a message states '-TIN' pin is configured as communication input'. At the bottom, there are four buttons: 'Save Config', 'Factory default', 'Cancel', and 'Load Config' (highlighted with a red box), and 'OK'.

Gain: Adjustment of Gain
Offset: Adjustment of a temperature offset

For certain applications or under certain circumstances a temperature offset or a change of the gain for the temperature curve may be useful.

The factory default settings for Gain and Offset are:

- Gain: 1,000
- Offset: 0,0 K

A changed **Offset** causes a parallel shifting of the temperature curve and therewith it has a linear effect on the temperature reading (change constant independent on object temperature). A change of the Gain will have a non-linear effect on the temperature reading (change depends on object temperature).

Sensor Setup CS/ CSmicro

The button **Setup** [Menu: Device\ Device Setup] opens a dialog window for set up the parameters of the sensor.

General

Signal processing	Vcc adjust		Calibration
General	IN/OUT (green)	OUT (yellow)	Status LED
General setup			
Transmission:	<input type="text" value="1.000"/>		
Avg. Time [s]:	<input type="text" value="0.100"/>		
Avg. mode:	<input type="text" value="smart"/>		
Avg. hysteresis [°C]:	<input type="text" value="5.0"/>		
Emissivity fix value:	<input type="text" value="0.950"/>		
Ambient temp. source:	<input type="text" value="Internal (Head)"/>		
Ambient temperature: [°C]:	<input type="text" value="23.0"/>		
"IN/OUT" pin is configured as			
communication input			
"OUT" pin is configured as			
mV output			
<input type="button" value="Save Config"/>	<input type="button" value="Factory default"/>	<input type="button" value="Cancel"/>	
<input type="button" value="Load Config"/>	<input type="button" value="OK"/>		

Transmission:	Transmissivity setting
Avg. Time:	Average time setting
Avg. mode:	Selection between smart and normal mode
Avg. hysteresis:	Adjustment of the minimum temperature difference for activation of the smart averaging function
Emissivity fix value:	Emissivity setting (Fixed value)
Ambient temp. source ²⁾ :	Selection between Internal (Head) , or Fixed value
Ambient temperature ²⁾ :	Value input for mode Fixed value

In the lower range of the unit adjustment window the current use of the **IN/ OUT** (green) and **OUT** (yellow) pins will be shown.

IN/ OUT (green) – ext. Emissivity/ Ambient temp. [CS/ CSmicro LT only]

The **IN/ OUT** pin can be programmed as an input as well as an output.

Signal processing		Vcc adjust		Calibration	
General	IN/OUT (green)	OUT (yellow)	Status LED		
Mode:					
ext. analog emissivity <IN>					
Slope settings:					
Emissivity @ 0V:		0,100			
Emissivity @ 10V:		1,100			
"IN/OUT" pin is configured as			"OUT" pin is configured as		
ext. analog emissivity			mV output		
Save Config		Factory default		Cancel	
Load Config				OK	

Mode:

Selection between:

ext. analog emissivity [IN] ¹⁾

ext. analog ambient [IN] ¹⁾

valid control high active (high level >0,8 V [IN])

valid control low active (low level <0,8 V) [IN]

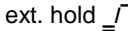
ext. hold  rising edge (edge level 0,8 V) [IN]

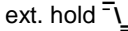
ext. hold  falling edge (edge level 0,8 V) [IN]

communication input [IN]

alarm output (open collector) [OUT]

temp. code indication (open collector) [OUT]

inactive ²⁾

ext. analog emissivity [IN]] ³⁾

Slope settings:

Emissivity @ 0V: lower range limit emissivity

Emissivity @ 10V: upper range limit emissivity

ext. analog ambient [IN]] ^{3) 4)}

Slope settings:

Temp. @ 0V: lower range limit ambient temp.

Temp. @ 10V: upper range limit ambient temp.

¹⁾ only available on CS/ CSmicro LT

^{2) 3)} for explanation see next page

- 2) If the mV output is used exclusively the **IN/ OUT** pin should be set to **inactive** to avoid interferences. If **mV output** is selected in the tab **OUT (yellow)** the IN/ OUT pin is set automatically to inactive for this reason.
- 3) If the function **ext. analog emissivity** or **ext. analog ambient** is selected the **IN/ OUT** pin acts as analog input. Via a voltage (0-10 V) on the **IN/ OUT** pin the emissivity or ambient temperature (see footnote 2) can be adjusted remotely. The range limits can be adjusted using the slope settings.
- 4) For the compensation of the ambient temperature the internal head temperature is used if **Internal (Head)** is selected. In dependence on the emissivity value of the object a certain amount of ambient radiation will be reflected from the object surface. Therefore for certain applications it may be useful taking the ambient temperature on the object site for compensation (if significant different from head ambient temperature e.g.).

The following settings can be made:

- **ext. analog ambient temperature (tab: IN/ OUT):**

Using the IN/ OUT pin you can control the ambient temperature value with an external voltage of 0-10 V.

- **Fixed value (tab: General):**

You can enter a value which represents the ambient radiation in the field **Ambient temperature**.

IN/ OUT (green) – ext. Trigger

To trigger the measurement signal the following functions are available:

Valid control – high active

The output follows the object temperature as long as there is a High level (>0,8 V) at the **IN/ OUT** pin. After discontinuation of the High level the last value will be held.

Valid control – low active

The output follows the object temperature as long as there is a Low level (<0,8 V) at the **IN/ OUT** pin. After discontinuation of the Low level the last value will be held.

ext. Hold $\overline{\text{r}}$ rising edge

The last value will be held if there is a signal with a rising edge (level 0,8 V) at the **IN/ OUT** pin.

ext. Hold $\overline{\text{f}}$ falling edge

The last value will be held if there is a signal with a falling edge (level 0,8 V) at the **IN/ OUT** pin

IN/ OUT (green) – Communication input

The input for the digital communication can be activated and used independent on the communication output. (to change sensor parameters via binary commands e.g.). The maximum UART voltage should not exceed 3,3 V.

[► Sensor manual: Digital Commands]

IN/ OUT (green) – Alarm Output (open collector)

With this function an additional alarm output (open collector output) at the **IN/ OUT** pin will be activated.

[▶ Sensor manual: Electrical installation]

Signal processing		Vcc adjust		Calibration	
General		IN/OUT (green)		OUT (yellow)	
				Status LED	
Mode:					
alarm output (open collector) <OUT->					
Alarm settings:					
Source:	Process temp	<input checked="" type="checkbox"/>	tempcode indication for values above alarm levels		
Mode:	Normally open	Range settings:			
Alarm threshold [°C]:	40.0	Temp min [°C]:	0.0	= 0%	
Difference mode (TOB)-Tamb)	<input checked="" type="checkbox"/>	Temp max [°C]:	100.0	= 100%	
"IN/OUT" pin is configured as					
alarm output (open collector)					
"OUT" pin is configured as					
mV output					
Save Config		Factory default		Cancel	
Load Config				OK	

Source:

Selection between:

Process temperature

Act. object temperature

Head temperature

Electronic temperature

normally open/ closed

Mode:

Alarm threshold:

Temperature for alarm activation

Difference mode:

If activated, the difference between object temp. and ambient temp. will be used for the alarm threshold.

Temp. code output:

If activated, in case of an active alarm the current temperature will be given out as temp. code via the open collector output.

Range settings:

Definition of the range limits for the temp. code output (0 and 100% value)

IN/ OUT (green) – Temp. Code Output (open collector)

With this function an output of the **temperature code** (open collector output) at the **IN/ OUT** pin will be activated.

The screenshot shows a configuration window with the following elements:

- Tabbed interface: Signal processing (selected), Vcc adjust, Calibration.
- Sub-tabs: General, IN/OUT (green) (selected), OUT (yellow), Status LED.
- Mode: A dropdown menu showing "temp. code output (open collector)" and a "<OUT>" button.
- Range settings: Two input fields. "Temp min [°C]: 0.0 = 0%" and "Temp max [°C]: 100.0 = 100%".
- Summary: Two rows showing pin configurations. "IN/OUT" pin is configured as "temp. code output (open collector)". "OUT" pin is configured as "mV output".
- Buttons: "Save Config", "Factory default", "Cancel", "Load Config", "OK".

Range settings: Definition of the range limits for the temp. code output (0 and 100% value)

Analog Output (mA)/ Alarm Output [CSmicro 2W]

Status LED	Signal processing	Calibration
General	mA output	INI/OUT (green) OUT (yellow)
Mode: mA output		
mA settings :		Failsafe settings :
Temp min [°C]:	0,0	<input checked="" type="checkbox"/> Headtemp. failsafe
Temp max [°C]:	350,0	Temp min: [°C]: 0,0 [mA]: 4,0
mA min :	4,0	Temp max: [°C]: 80,0 [mA]: 20,0
mA max :	20,0	<input checked="" type="checkbox"/> Targettemp. failsafe
Slope :	0,0 mA/K	Temp min: [°C]: 0,0 [mA]: 4,0
Adjust output slope		Temp max: [°C]: 500,0 [mA]: 20,0
<input checked="" type="checkbox"/> Failsafe aktivieren		
INI/OUT* pin is configured as: alarm output (open collector)		
OUT* pin is configured as: burst output		
Save Config	Factory default	Cancel
Load Config	OK	

Mode: Selection between:
mA output [analog]
mA alarm output [two-level alarm]

mA output

Temp min: Lower limit temperature range
Temp max: Upper limit temperature range
mA min: Lower output range
mA max: Upper output range
Failsafe settings¹⁾: Definition of failsafe modes

If the sensor will be connected to the supply voltage, the unit is checking for the first 300ms if a USB adapter is connected. In this case the bidirectional communication mode will be activated automatically.

¹⁾ The settings for failsafe mode enable a defined level on the analog output in dependence on preset temperature limits for object temperature and/ or sensing head temperature (**Temp min** and **Temp max**).

You can adjust the temperature range of the sensor by pressing the button **Adjust output slope**. The range limits can either be entered directly in the input fields or by shifting the output function graph (by catching the points **LOW** or **HIGH** with the cursor).

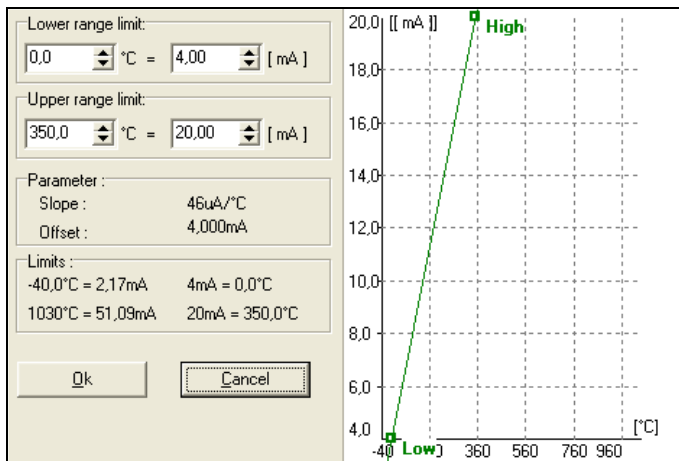

Status LED	Signal processing	Calibration
General	mA output	IN/OUT (green) OUT (yellow)
Mode: mA alarm output		
Alarm settings:		
Source:	Process temp	
Mode:	Normally open	
Alarm threshold [°C]:	40.0	
Difference mode (TObj-TAmb)	<input type="checkbox"/>	
Lower alarm current	4.0	
Upper alarm current	20.0	
"IN/OUT" pin is configured as alarm output (open collector)		
"OUT" pin is configured as burst output		
Save Config	Factory default	Cancel
Load Config		OK

alarm output

Source:

Selection between:

- Process temperature
- Act. object temperature
- Head temperature
- Electronic temperature

Mode:

normally open/ closed

Alarm threshold:

Temperature for alarm activation

Difference mode:

If activated, the difference between object temp. and ambient temp. will be used for the alarm threshold.

Low alarm current:

lower alarm output value

High alarm current:

higher alarm output value

OUT (yellow) – Analog Output (mV)/ Alarm Output [CS/ CSmicro LT]

Mode:

Selection between:

- mV output [analog]
- alarm output [two-level alarm]
- 3-state output [three-level alarm]
- communication output [bidirectional digital]
- burst [unidirectional digital]
- [double sensing](#)
- TC K output [CS only]
- 0...1 V output

mV output

- Temp min: Lower limit temperature range
- Temp max: Upper limit temperature range
- mV min: Lower output range
- mV max: Upper output range
- Failsafe settings¹⁾: Definition of failsafe modes

¹⁾ The settings for failsafe mode enable a defined level on the analog output in dependence on preset temperature limits for target temperature and/ or sensing head temperature (**Temp min** and **Temp max**).

If the sensor will be connected to the supply voltage, the unit is checking for the first 300ms if a USB adapter is connected. In this case the bidirectional communication mode will be activated automatically.

If the **mV output** is selected the **IN/ OUT** pin will switch automatically to **inactive** (default setting).

You can adjust the temperature range of the sensor by pressing the button **Adjust output slope**. The range limits can either be entered directly in the input fields or by shifting the output function graph (by catching the points **Low** or **High** with the cursor).

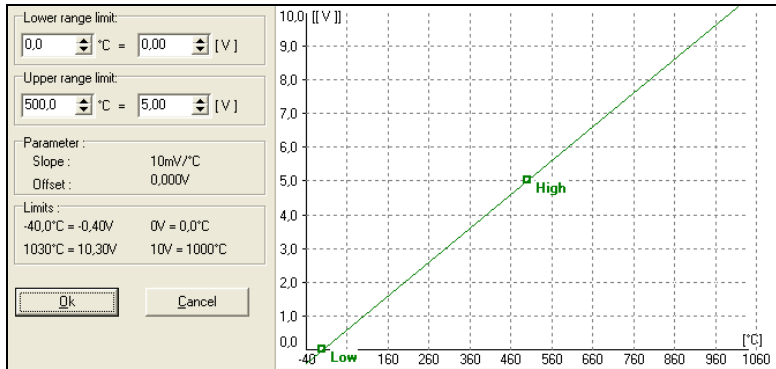

Signal processing		Vcc adjust	Calibration
General	IN/OUT (green)	OUT (yellow)	Status LED
Mode: alarm output			
Alarm settings:			
Source:	Process temp		
Mode:	Normally open		
Alarm threshold [°C]:	<input type="text" value="40.0"/>		
Difference mode (TObj-TAmb)	<input checked="" type="checkbox"/>		
Low alarm voltage [V]:	<input type="text" value="0.0"/>		
High alarm voltage [V]:	<input type="text" value="10.0"/>		
"IN/OUT" pin is configured as:			
ext. analog emissivity			
"OUT" pin is configured as:			
alarm output			
<input type="button" value="Save Config"/>	<input type="button" value="Factory default"/>	<input type="button" value="Cancel"/>	
<input type="button" value="Load Config"/>	<input type="button" value="OK"/>		

alarm output

Source:

Selection between:

- Process temperature
- Act. object temperature
- Head temperature
- Electronic temperature

Mode:

normally open/ closed

Alarm threshold:

Temperature for alarm activation

Difference mode:

If activated, the difference between object temp. and ambient temp. will be used for the alarm threshold.

Low alarm voltage:

lower alarm output value

High alarm voltage:

higher alarm output value

OUT (yellow) – 3-state Output [CS/ CSmicro LT]

Signal processing	Vcc adjust	Calibration
General	IN/OUT (green)	OUT (yellow) Status LED
Mode: 3-state output		
3-state output mode:		
Alarm threshold [°C]: 40,0		
Difference mode (TObj-TAmb) <input checked="" type="checkbox"/>		
prealarm diff. [°C]: 5,0		
Three-state alarm output:		
no Alarm [V]: 5,0		
prealarm [V]: 2,0		
alarm [V]: 0,0		
voltage for service [V]: 5 At Vcc=5V the unit works in analog mode.		
IN/OUT pin is configured as temp. code output (open collector)		
OUT pin is configured as 3-state output		
Save Config	Factory default	Cancel
Load Config		OK

3-state Output

Alarm threshold:
Difference mode:

Temperature for alarm activation
If activated, the difference between object temp. and ambient temp. will be used for the alarm threshold.

Prealarm diff.:

Temperature difference related to the alarm threshold value; the prealarm will be activated at alarm threshold – prealarm diff.

No Alarm:

Voltage level setting for status: no alarm

Pre-alarm:

Voltage level setting for status: pre-alarm

Alarm:

Voltage level setting for status: alarm

Voltage for service:

Setting of a supply voltage level (Vcc) at which the unit works as analog device (mV output)

The sensor is equipped with a 3-state alarm output which is useful for temperature monitoring applications. This output provides beside the main alarm a so called pre-alarm. This pre-alarm will be activated if the object temperature exceeds a defined critical value which is below the actual alarm level (pre-alarm diff.).

In order to increase the system safety furthermore the output voltage level for alarm should be 0 V – in this case also a defect sensor would activate the alarm.

The sensor can be switched into the standard analog mode (mV output) by varying the supply voltage (voltage for service).

If the function **Vcc adjust** is used simultaneously the alarm values from Vcc adjust tabel are used for the 3-state output:

Signal processing	Vcc adjust	Calibration
General	IN/OUT (green)	OUT (yellow) Status LED
Mode: 3-state output		
3-state output mode :		
Alarm threshold [°C]:	40,0	alarm values are used from Vcc adjust table
Difference mode (TObj-TAmb)	<input checked="" type="checkbox"/>	
prealarm diff. [°C]:	5,0	

OUT (yellow) – Digital Outputs

In the selection field **Mode** you can switch the output to digital communication. You can select between **communication output** (bidirectional digital communication for interaction with the software) and **burst output**.

The screenshot shows the 'OUT (yellow)' configuration window. The 'Mode' dropdown is set to 'burst output'. The 'Burstmode' section contains eight dropdown menus for 'Value 1' through 'Value 8' and an 'Interval' dropdown set to '15 ms'. Below this, the 'IN/OUT' pin configuration is shown as 'inactive' and 'burst output'. At the bottom are buttons for 'Save Config', 'Factory default', 'Cancel', 'Load Config', and 'OK'.

Burst output

Value 1...8:

Selection between:

<none>

Process temperature

Internal temperature

Emissivity

Transmissivity

Ambient temperature

Act. target temperature

Electronic temperature

mV input (IN/ OUT green)

mV power supply

Interval:

Setup of the interval [15ms...1s]

In the burst mode the sensor works in a unidirectional communication mode – the sensor is sending data continuously. The burst string can be configured by selection of value 1 to 8.

[▶ Command List on software CD]

Status LED – LED Alarm/ Automatic Aiming Support

The green LED at the end of the sensor housing (CS) or inside the electronics (CSmicro) can be used for different functions:

The screenshot shows the 'Status LED' configuration window. It has a tabbed interface with 'General', 'IN/OUT (green)', 'OUT (yellow)', and 'Status LED' tabs. The 'Status LED' tab is active. The 'Mode' dropdown is set to 'LED alarm'. Under 'Alarm settings', 'Source' is 'Process temp', 'Mode' is 'Normally open', and 'Alarm threshold [°C]' is '100.0'. There is an unchecked checkbox for 'Difference mode (TOBj-TAmb)'. At the bottom, there are buttons for 'Save Config', 'Factory default', 'Cancel', 'Load Config', and 'OK'. A status bar at the bottom indicates: '"IN/OUT" pin is configured as alarm output (open collector)' and '"OUT" pin is configured as mV output'.

Mode: Selection between:
 Off
 LED Alarm
 Automatic aiming support
 Self diagnostic
 Temp. code indication

LED Alarm

Source: Selection between:
 Process temperature
 Act. object temperature
 Head temperature
 Electronic temperature

Mode: normally open/ closed

Alarm threshold: Temperature for alarm activation

Difference mode: If activated, the difference between object temp. and ambient temp. will be used for the alarm threshold.

The screenshot shows the 'Automatic Aiming Support' configuration window. It has a tabbed interface with 'General', 'IN/OUT (green)', 'OUT (yellow)', and 'Status LED'. The 'General' tab is active. Under 'Mode', a dropdown menu is set to 'automatic aiming support'. Below this, the 'Aiming support settings' section contains: 'Mode' dropdown set to 'searching maximum', 'Hysteresis [°C]' text box with '2.0', and 'Reset Time [s]' text box with '10.0'. At the bottom, there are four buttons: 'Save Config', 'Factory default', 'Cancel', and 'Load Config'. The 'OK' button is highlighted with a dashed border.

Automatic Aiming Support

Mode:	<u>Selection between:</u> Searching maximum Searching minimum
Hysteresis:	Adjustment of the minimum temperature difference for activation of the function
Reset time:	After the set time the search function will be reset.

The function **Automatic Aiming Support** helps to adjust the unit to an object which has a temperature different to the background. The sensor is looking for the highest object temperature (mode: searching maximum); means the threshold value for activating the LED will be automatically tuned. This works also if the sensor is aimed at a new object (with probably colder temperature). After expiration of a certain reset time (standard: 10s) the sensor will adjust the threshold level for activation of the LED new.

Status LED – Self Diagnostic

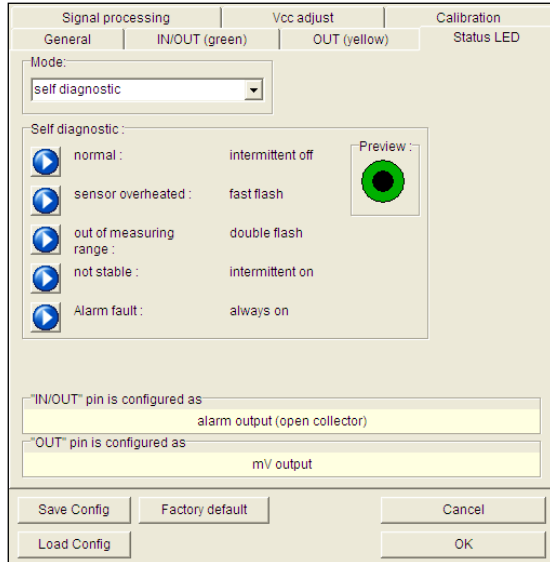

If activated, the LED will show one out of five possible states of the sensor:

Status	LED mode	
Normal	intermittent off	- - - -
Sensor overheated	fast flash	-----
Out of measuring range	double flash	-- -- -- --
Not stable	intermittent on	=====
Alarm fault	always on	=====

The preview of the different LED modes can be activated by clicking on the respective sign: 

- Sensor overheated:** The internal temperature probes have detected an invalid high internal temperature of the sensor.
- Out of measuring range:** The object temperature is out of measuring range.

- Not stable:** The internal temperature probes have detected an unequally internal temperature of the sensor.
- Alarm fault:** Current through the switching transistor of the open-collector output is too high.

Status LED – Temperature Code Indication

With this function the current measured object temperature will be indicated as percentage value by long and short flashing of the LED.

At a range setting of **0-100 °C** → **0-100%** the LED flashing indicates the temperature in °C.

Signal processing | Vcc adjust | Calibration

General | IN/OUT (green) | OUT (yellow) | Status LED

Mode:
temp. code indication

Range settings:
Temp min. [°C]: 0,0 = 0%
Temp max. [°C]: 100,0 = 100%

Examples:
24%
31%
8%

Preview:

"IN/OUT" pin is configured as:
alarm output (open collector)

"OUT" pin is configured as:
mV output

Save Config | Factory default | Cancel
Load Config | OK

Long flashing → first digit:	xx
Short flashing → second digit:	xx
10-times long flashing → first digit=0:	0x
10-times short flashing → second digit=0:	x0

Examples

87 °C	8-times long flashing indicates	87
and afterwards	7-times short flashing indicates	87
31 °C	3-times long flashing indicates	31
and afterwards	1-time short flashing indicates	31
8 °C	10-times long flashing indicates	08
and afterwards	8-times short flashing indicates	08
20 °C	2-times long flashing indicates	20
and afterwards	10-times short flashing indicates	20

Signal Processing

General	IN/OUT (green)	OUT (yellow)	Status LED
Signal processing	Vcc adjust	Calibration	
<input type="checkbox"/> Post processing Hold-mode: <input type="text" value="Peak hold"/>			
Hold-time [s]: <input type="text" value="2.0"/> (999.9 = infinite)			
<input type="checkbox"/> "IN/OUT" pin is configured as <div style="background-color: yellow; padding: 2px;">alarm output (open collector)</div>			
<input type="checkbox"/> "OUT" pin is configured as <div style="background-color: yellow; padding: 2px;">mV output</div>			
<input type="button" value="Save Config"/>		<input type="button" value="Factory default"/>	
<input type="button" value="Load Config"/>		<input type="button" value="Cancel"/>	
		<input type="button" value="OK"/>	

Hold mode:

Selection between:

Off

Peak hold

Valley hold

Advanced peak hold

Advanced valley hold

Hold time:

Hold time adjustment
(999,9 = infinite)

In the **Peak hold** mode the sensor is waiting for descending signals. If the signal descends the algorithm maintains the previous signal peak for the specified **Hold time**.

In the **Valley hold** mode the sensor waits for ascending signals. If the signal ascends the algorithm maintains the previous signal valley for the specified **Hold time**.

You will find a detailed description of these functions under ► **Post Processing**.

Vcc Adjust [CS/ CSmicro LT]

General	IN/OUT (green)	OUT (yellow)	Status LED
Signal processing		Vcc adjust	Calibration
<input checked="" type="checkbox"/> Vcc adjust : output voltage range : <input type="checkbox"/> Uout 0 - 5V <input checked="" type="checkbox"/> Uout 0 - 10V			
	Emiss.	Alarm(IN/OUT)	Difference mode
Vcc=11V	0,950	[°C]: 40,0	<input checked="" type="checkbox"/>
Vcc=12V	0,830	[°C]: 45,0	<input checked="" type="checkbox"/>
Vcc=13V	0,760	[°C]: 50,0	<input checked="" type="checkbox"/>
Vcc=14V	0,955	[°C]: 55,0	<input checked="" type="checkbox"/>
Vcc=15V	0,685	[°C]: 60,0	<input checked="" type="checkbox"/>
Vcc=16V	0,660	[°C]: 65,0	<input checked="" type="checkbox"/>
Vcc=17V	0,900	[°C]: 70,0	<input checked="" type="checkbox"/>
Vcc=18V	0,950	[°C]: 75,0	<input checked="" type="checkbox"/>
Vcc=19V	0,950	[°C]: 80,0	<input checked="" type="checkbox"/>
Vcc=20V	0,950	[°C]: 85,0	<input checked="" type="checkbox"/>
<input type="checkbox"/> IN/OUT pin is configured as alarm output (open collector)			
<input type="checkbox"/> OUT pin is configured as mV output			
Save Config		Factory default	
Load Config		OK	
		Cancel	

If this function is activated you can switch between 10 different emissivity settings combined with alarm threshold values by variation of the supply voltage (Vcc).

Output voltage range: Selection between 0-5 V or 0-10 V voltage output
 0-5 V output → 6-15 V adjustment range
 0-10 V output → 11-20 V adjustment range

Difference mode: If activated, the difference between object temp. and ambient temp. will be used for the alarm threshold.

The set alarm values [Alarm (IN/ OUT)] will only affect the open collector output. Therefore, if the Vcc adjust mode is used, the IN/ OUT pin should be set to **alarm output (open collector)**.

Loop Maintenance

This function enables a verification of the analog output (on CT models in addition output channel 2). An input will set the sensor output to the according percentage of the output range or to a fixed mV value or mA value.

An input in field **Ambient out** [CT models only] will set the **output channel 2** to the according percentage value of the adjusted output range.

The button **Reset to normal mode** will deactivate the loop maintenance – the sensor outputs will follow the current object or ambient temperature again.

Any change of this values sets the custom output to a fixed percentage of range.

IR out [%]: 50

Ambient out [%]: 100

Reset to normal mode

Close and reset to normal mode

**CT [example: 50% of range (IR)/
100% of range (Amb.)]**

Any change of this value sets the custom output to a fixed mV value.

mV [1/10 V]: 50

Reset to normal mode

Close and reset to normal mode

CS [example: 5 V]

Any change of this value sets the mA output to a fixed mA value.

mA out [1/10 mA]: 200

Reset to normal mode

Close and reset to normal mode

CSmicro 2W [example: 20 mA]

Saving the Sensor Configuration

In each window which you enter with the button **Setup** [Menu: Device\ Device Setup] you will find at the bottom edge the following buttons for saving of the sensor configuration:



Save Config

With this button you can save the current configuration of the connected sensor in a file (ending: *.cfg).

An explorer window will be opened and enables definition of filename and destination.

Load Config

A previous saved configuration can be opened and stored into the connected sensor.

Factory default

This button enables the user to reset the unit to the factory default values (CS/ CSmicro/ CX only). Sensors of the CT/ CTlaser/ CTratio series can be reset by pressing at first the **Down** button and then the **Mode** button (keep both pressed for approx. 3 seconds).

After pressing **OK** all changes and settings will apply.

Emissivity Calculation

The button **Emiss.** [Menu: Device\ Change Emissivity] opens a window in which you can enter the current emissivity value of your object. The function **Emissivity calculation** determines an unknown emissivity based on a known object temperature.

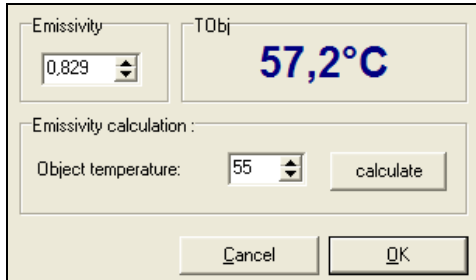

Please enter the object temperature which you have determined before with another sensor (thermocouple e.g.) in the field **Object temperature**. After you have pressed the **calculate** button the calculated emissivity will be shown in the field **Emissivity** and taken over into the connected sensor.

To determine the emissivity the object temperature should be different from the ambient temperature.

Smart Averaging

The average function is generally used to smoothen the output signal. With the adjustable parameter time this function can be optimal adjusted to the respective application. One disadvantage of the average function is that fast temperature peaks which are caused by dynamic events are subjected to the same averaging time. Therefore those peaks can only be seen with a delay on the signal output.

The function **Smart Averaging** eliminates this disadvantage by passing those fast events without averaging directly through to the signal output.

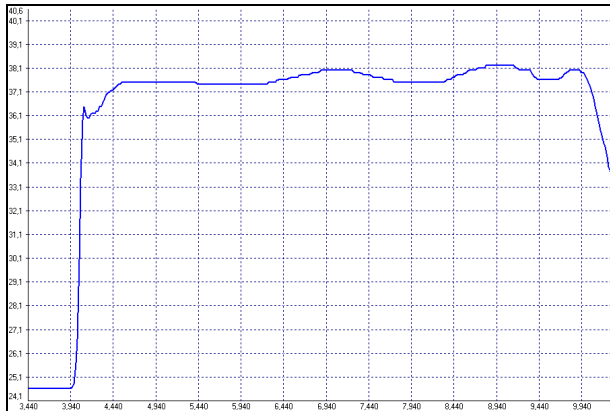

Signal graph with Smart Averaging function

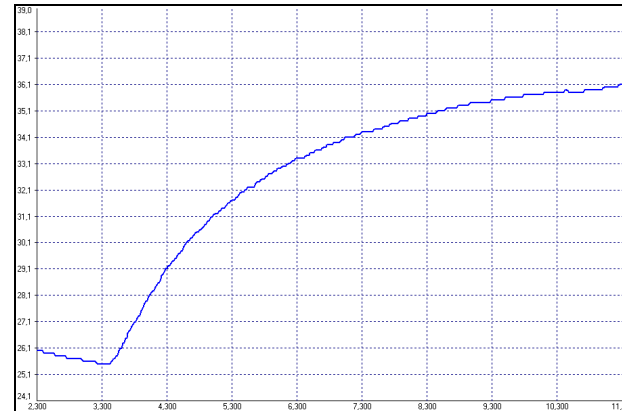

Signal graph without Smart Averaging function

Binary Chat Program

On the program CD you will find an additional program for a simple check of the digital communication of the connected sensor. Please copy the application (BinaryChat.exe) out of the folder on the CD **Binary Chat Program** on your desktop or into any desired folder on your hard disc drive of your PC. After starting the program the following window will appear:

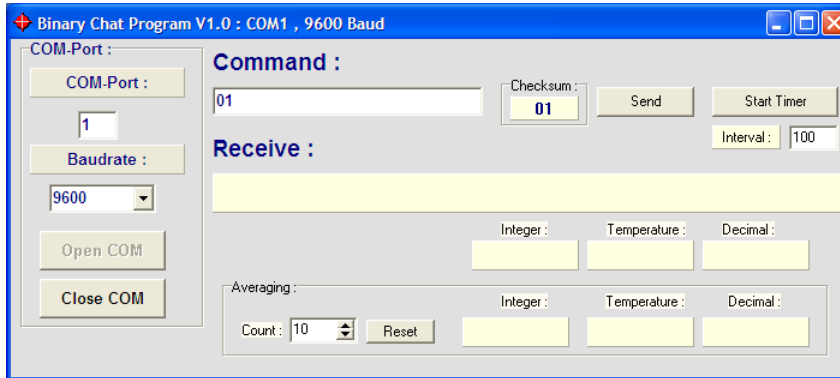

Please select at first the COM port of the connected sensor (you will find this information in the status line of your CompactConnect or in the device manager of your PC).

Please enter the **Baudrate** your sensor is working with.

Now you can open the COM port by pressing the button **Open COM**.

Before you open the COM port please close the CompactConnect software as this application may access the same sensor/ COM port. Please make sure that the sensor is set to bidirectional digital communication.

Now you can enter a binary command as hexadecimal value out of the according command list of the connected sensor. After pressing **Send** the answer will be shown in the line **Receive** (also as HEX value). Below the receive line you will find the **Integer** decimal value of the answer as well as the calculated **Temperature** or the **Decimal** value which is calculated by dividing the answer by 1000. This calculation is used for the emissivity value e.g.

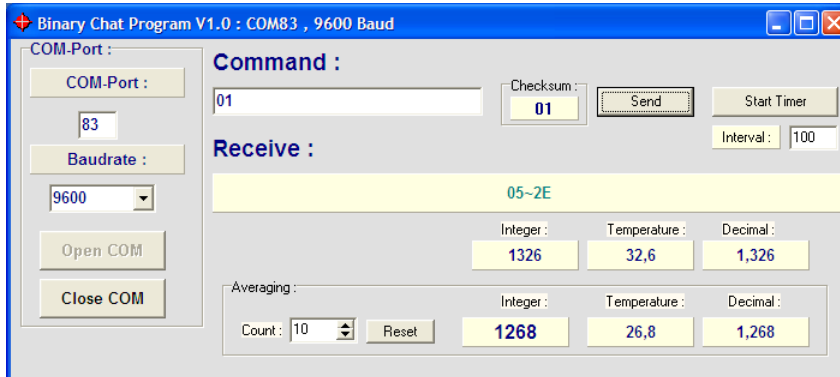

Example 1: CSmicro 2WLT/ Polling of the object temperature

Example 1 shows the polling of the object temperature from a CSmicro. This is done according to the command list (CD: \Commands):

Readout of object temperature			
Send:	01	Command for readout of object temperature	
Receive:	04 D3	Object temperature in tenth degree + 1000	04 D3 = dec. 1235
			1235 - 1000 = 235
			235 / 10 = 23,5 °C

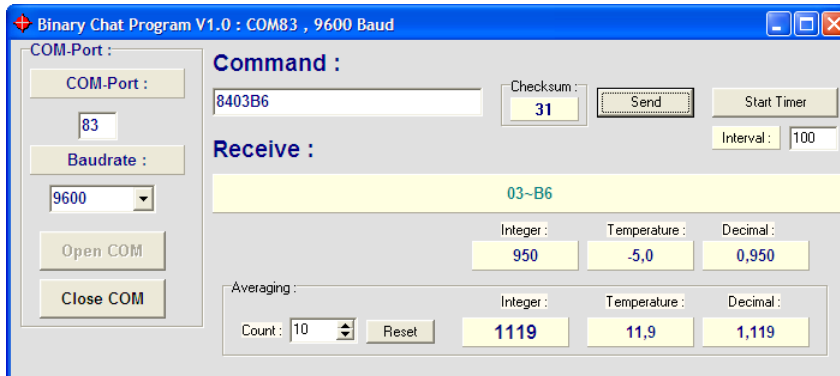

Example 2: CSmicro 2WLT/ Set of emissivity value

In example 2 the sending of the command and the calculating of the emissivity out of the answer is done also according to the command list. The emissivity value can be read at **Decimal**:

Set of emissivity			
Send:	84 03 B6		03B6 = dec. 950
Receive:	03 B6		950 / 1000 = 0,950

Additional Features

Under **Averaging** you can calculate the average value out of a defined number of values **Count**.

If you press the button **Start Timer** you can activate a repeated polling of values (useful for object temperature e.g.). The polling **Interval** can be set (in ms).

Please use only times >50 ms, as otherwise you may receive wrong data.

Menu Overview

[File](#)

[Measurement](#)

[Device](#)

[Diagram](#)

[View](#)

[Preferences](#)

[Help](#)

[Context Menu \(right mouse button\)](#)

Menu: File

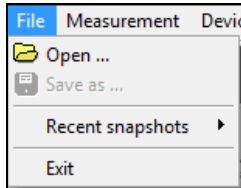

Open...

To open saved temperature files (*.dat)

Save as...

To save temperature files

Recent snapshots

Opens a list with the last 10 snapshots

open folder: opens the defined folder for snapshots

Exit

To exit the program

Menu: Measurement

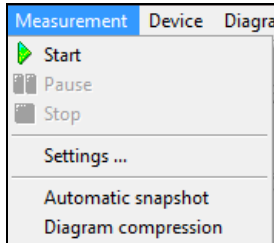

Start

To start the measurement

Pause

To freeze the continuous diagram actualization

Stop

To stop the measurement

Settings...

Opens the window: **Measurement configuration**

Automatic snapshot

Opens the configuration window for automatic snapshots

Diagram compression

Opens the configuration window for diagram compression

Menu: Device

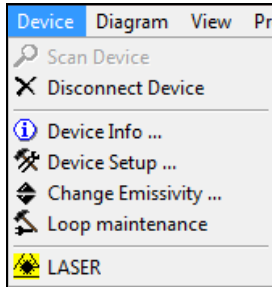

Scan Device

Disconnect Device

Device Info...

Device Setup...

Change Emissivity...

Loop Maintenance

LASER

Scans for connected sensors (if Auto scan is deactivated)

The connection will be determined and the COM port will be closed.

Shows information about the connected unit (firmware revision etc.).

Opens the window: Device setup

Adjustment/ Calculation of the Emissivity

Verification of the analog output channels.

To switch On and Off the Laser (not at CS/ CSmicro/ CX)

Activation via ► **Basic Settings**

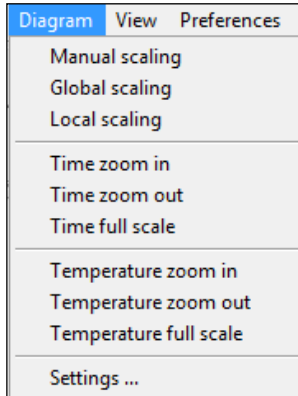
Menu: Diagram

Temperature zoom in
Temperature z. out
Temperature full sc.
Settings...

Manual Scaling
Global auto scaling

Manual scaling of the temperature axis
 The temperature range of the diagram will be adapted automatically to the respective peak values. The range will stay in this setting during the whole measurement.

Local auto scaling

The temperature range of the diagram will be adapted dynamically to the respective peak values. After the respective peak has left the diagram the range will be readapted.

Time zoom in
Time zoom out
Time full scale

A selected part of the diagram will be stretched.
 A selected part of the diagram will be clinched.
 Shows the whole time range of the measurement.

To scale up a part of the temperature axis.
 To scale down a part of the temperature axis.
 Shows the whole temperature range
 Opens the window: **Diagram settings** to select digital displays, temperature graphs, pen width and color of graphs

Menu: View

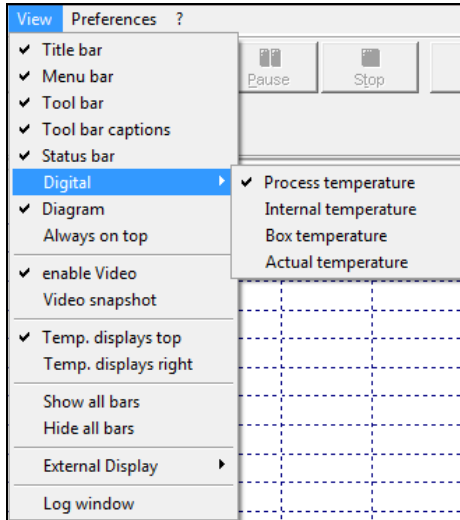

Title bar

To show or hide the title bar of the software window

Menu bar

To show or hide the menu bar of the software window

Tool bar

To show or hide the tool bar

Tool bar captions

To show or hide the captions of the tool bar

[Menu Overview](#)

Status bar	To show or hide the status bar
Digital	Selection of all available values which can be shown as a digital display
Diagram	To show or hide the temperature diagram
Always on top	If activated, the software screen will always visible on top (independent on other active applications)
enable Video	To switch on and off the video display
Video snapshot	To make a snapshot
Temp. displays top	The digital display group will be located on the top right corner of the software screen
Temp. display right	The digital display group will be located on the right side of the software window
Show all bars	All bars will be shown (title-, menu-, tool- and status-bar)
Hide all bars	All bars will be hidden (title-, menu-, tool- and status-bar)
External Display	To open an external display
Log window	Display of logged software events

Menu: Preferences

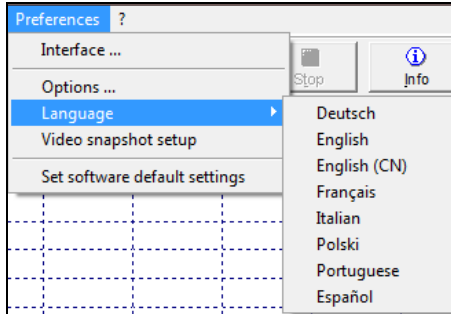

Interface...

Options...

Language

Video snapshot setup

Set software default settings

Settings for device scan, COM port information etc.

Opens the window: **Options** to make basic settings and define options for data saving

To select the desired language

Opens the configuration window for video snapshots

The software will be reset to the factory default settings
(The sensor settings are not affected by this)

Menu: Help

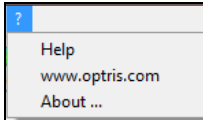

Help...

www.optris.com

About...

To open the help file

Opens the Optris homepage in your web browser

To show the software version installed on your computer

Context Menu (right mouse button)

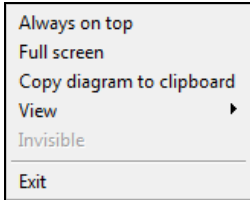

Always on top

Shows the application permanently on top of the screen, independent of other active windows

Full screen

Shows the application as full screen

Copy diagram to clipboard

The diagram will be copied into the clipboard

View

Linking to the sub menu **View**

Invisible

Closes the application window (the software is running in the background as process) – only the external displays are further visible

Exit

To exit the program

Context Menu [Sub menu: View]

Title bar
Menu bar
Tool bar
Tool bar captions
Status bar
Diagram
Enable Video
Video Snapshot
Temp. displays top
Temp. displays right
Show all bars
Hide all bars
external display ▶

Title bar	Shows or hides the title bar
Menu bar	Shows or hides the menu bar
Tool bar	Shows or hides the tool bar
Tool bar captions	Shows or hides the tool bar captions
Status bar	Shows or hides the status bar
Diagram	Shows or hides the diagram
Enable Video	To switch on and off the video display
Video Snapshot	To make a snapshot
Temp. displays top	Places the digital displays on top of the diagram
Temp. displays right	Places the digital displays right of the diagram
Show all bars	Shows all bars at once
Hide all bars	Hides all bars at once
External display	Linking to the sub menu External display

Context Menu [Sub menu: External display]

TProcess
TIntern
TAct
TBox
T_1C
T_2C
Attenuation
Pressure
Eps.
TAmb
Vcc

In this menu you can call separate digital displays for the different signals. These displays will also be shown if the application runs in the invisible mode. The displays are always on top of the PC screen.