



WICKSTEED
playscapes



Woodland
Multi-Play System
Age range 6 to 14

Wicksteed - Naturally

Woodland is an ideal play system for rural parkland settings, community playgrounds and schools.

Using European pine timber from sustainable managed forests, which is laminated to prevent moisture being absorbed, Woodland also has the advantage of metal below-ground fixings - enabling a 15-year anti-rot guarantee.

Deck heights: 600mm, 800mm and 1100mm



Gnu

Product code 6180-GNU



8 Play Features

- Woodland Tower with 1100mm high deck
- Two Handrails
- Net Ramp
- High Jungle Steps
- High Slide
- High Fireman's Pole
- Low Seat/Shop Counter

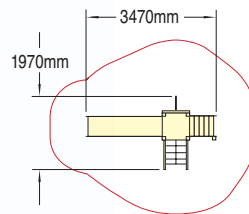

Wet Pour Safety Surfacing
1.1m FFH: 23m² x 40mm



Woodland Multi-Play System



29 Play Features

- Three Woodland Towers with 1100mm high decks
- Two Woodland Towers with 800mm high deck
- Three See-Through Flower Roofs
- Net Ramp
- Low Seat/Shop Counter
- Two Hippo Barriers
- High Slide
- Three Handrails
- Floating Step Bridge
- Half Round Vertical Net
- High Fireman's Pole
- Arch Bridge
- Balcony Barrier
- Elephant Barrier
- High Seat/Shop Counter
- Wavy Bridge
- Low Pull Up Ramp
- Rhino Barrier
- Vertical Net
- Low Slide
- Low Jungle Steps

Gazelle

Product code 6180-GAZ

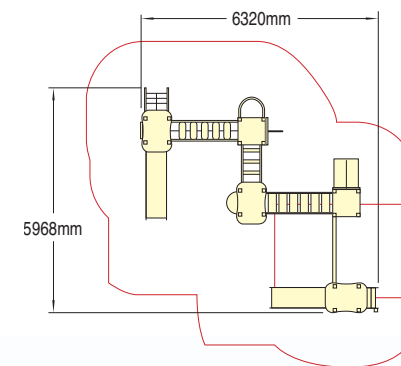

Wet Pour Safety Surfacing
1.6m FFH: 10m² x 60mm
1.1m FFH: 51m² x 40mm



Wombat

Product code 6180-WOM

9 Play Features

- Woodland Tower with 1100mm high deck
- See Through Flower Roof
- Two Handrails
- High Jungle Steps
- High Pull Up Ramp
- High Slide
- Vertical Net
- Woodland Ladder

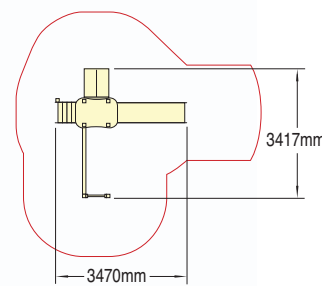

Wet Pour Safety Surfacing
1.6m FFH: 13m² x 60mm
1.1m FFH: 17m² x 40mm



Beaver

Product code 6180-BEA

13 Play Features

- Two Woodland Towers with 1100mm high decks
- See Through Flower Roof
- High Jungle Steps
- Hippo Barrier
- High Slide
- Handrail
- Low Seat/Counter
- Floating Step Bridge
- Half Round Vertical Net
- High Fireman's Pole
- Elephant Barrier
- Stepping Stone Beam



Wet Pour Safety Surfacing
1.1m FFH: 34m² x 40mm

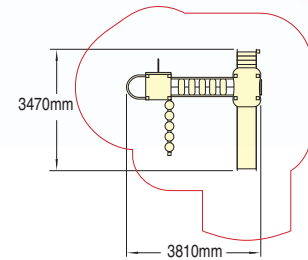

Woodland
Multi-Play System



Chinchilla

Product code 6180-CHI

15 Play Features

- Two Woodland Towers with 600mm high decks
- Four Handrails
- Two Handholds
- Two Small Mushroom Steps
- Two Large Mushroom Steps
- Elephant Barrier
- Floating Step Bridge
- Rhino Barrier



Wet Pour Safety Surfacing
0.6m FFH: 18m² x 20mm

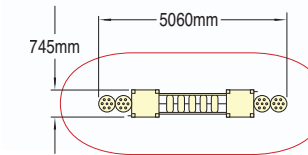

Dingo

Product code 6180-DIN

16 Play Features

- Two Woodland Towers with 800mm high decks
- Woodland Tower with 1100mm high deck
- See Through Flower Roof
- Rhino Barrier
- Balcony Barrier
- Low Pull Up Ramp
- Floating Step Bridge
- Low Slide
- Handrail
- Low Jungle Steps
- Wavy Bridge
- Half Round Vertical Net
- Elephant Barrier
- High Fireman's Pole
- High Seat/Shop Counter



Wet Pour Safety Surfacing
1.1m FFH: 40m² x 40mm

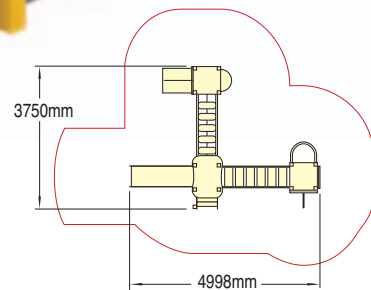

Wallaby

Product code 6180-WAL

21 Play Features

- Two Woodland Towers with 800mm high decks
- Two Woodland Towers with 1100mm high decks
- Low Fireman's Pole
- Two Elephant Barriers
- Two Hippo Barriers
- High Seat/Shop Counter
- Four Handrails
- Balcony Barrier
- Net Ramp
- Floating Step Bridge
- Low Pull Up Ramp
- Low Seat/Shop Counter
- High Slide
- Half Round Vertical Net



Wet Pour Safety Surfacing
1.1m FFH: 37m² x 40mm

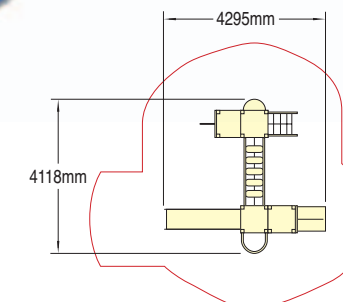

Play Features

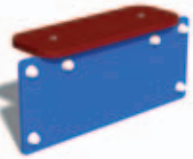

Low Seat/Shop Counter
Product code 6180-150



Large Mushroom Step
Product code 6180-151



Small Mushroom Step
Product code 6180-152



Low Jungle Steps
Product code 6180-153



High Jungle Steps
Product code 6180-154



Half Round Vertical Net
Product code 6180-155

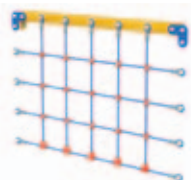

Vertical Net
Product code 6180-157



High Fireman's Pole
Product code 6180-158

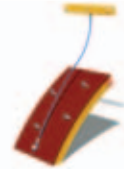

Low Pull Up Ramp
Product code 6180-159



High Pull Up Ramp
Product code 6180-160

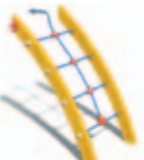

Net Ramp
Product code 6180-162

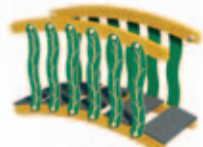

Arch Bridge
Product code 6180-164

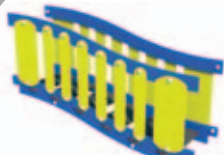

Wavy Bridge
Product code 6180-165



Floating Step Bridge
Product code 6180-166



Stepping Stone Beam
Product code 6180-167



Woodland Slide - 800mm
Product code 6180-169

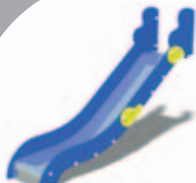

Woodland Slide - 1100mm
Product code 6180-170



See-Through Flower Roof
Product code 6180-172



Elephant Barrier
Product code 6180-173



Hippo Barrier
Product code 6180-174



Rhino Barrier
Product code 6180-175



Balcony Barrier
Product code 6180-176



Handhold
Product code 6180-177



Handrail
Product code 6180-178



Woodland Ladder
Product code 6180-179



Low Fireman's Pole
Product code 6180-180



High Seat/Shop Counter
Product code 6180-181

