

Product Overview

Aluminium Honeycomb Air Ventilation Panels consist of an aluminium honeycomb foil held in a rigid extruded aluminium mounting frame. The foil, formed and laminated into a series of honeycomb cells that are glued and perforated or laser welded at the join, ensures a conductive path at each join. Although the foil is conductive in all directions, to enhance EMI performance, two pieces of honeycomb polarised at 90° to each other are recommended.

The frame can be supplied with an integral or separate EMI/RFI gasket, and can be treated with a variety of finishes to provide corrosion protection or improve conductivity.

How do Honeycomb vents work:

The principle is that of "Waveguide beyond cutoff. The honeycomb vent is series of tubes that acts as a waveguide, guiding electromagnetic waves into or out of the enclosure, but as the tubes are long enough then it attenuates those waves. Typically the tube should be at least 3 times as long as the diameter. Good practice is 4 times. Therefore a 3.18mm cell should be 12.7mm long. Honeycomb material is used because it offers high shielding performance, light weight and good airflow.

A standard range of Honeycomb vents are available, drawings and part numbers are shown at the end of this data sheet.

Product Overview (Continued)

Applications

Ventilation panels are designed for use in electronic enclosures where good air flow is required for cooling and ventilation but where EMC compliance must be ensured. Typical applications are:

- Electronic Enclosures.
- Air Conditioning Units.
- Fan housings.
- EMC Racks.
- Communication shelters.

Availability

An extensive range of aluminium extrusion mounting frames are available from stock offering a choice of mounting methods and sizes.

Available as custom sizes with no additional cost.

Frames can be supplied with fixing holes or captive threaded inserts to aid mounting.

Honeycomb can be supplied in a number of configurations to suit different EMI/RFI Shielding performance requirements. Such as straight through, polarized and a choice of cell size.

Standard perforated honeycomb is available with 30°, 45°, 60° and 90° angles from stock and Laser welded aluminium honeycomb is also available to special order.

For vulnerable situations weld mesh or expanded aluminium kick plates can be fitted.

Removable dust filters and integral insect screens can also be provided.

A range of low cost standard fan vents are available to meet commercial applications where lower performance is acceptable, consisting of one layer of aluminium honeycomb held in a plastic frame.

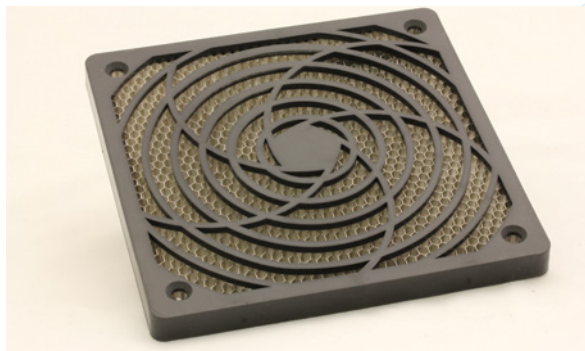

Design Considerations

Any environmental conditions such as moisture and dust control including:

- Air Flow requirement.
- External louvers for rain protection.
- Drain holes.
- Any additional gasketing.

Constructional requirements and finishes including:

- Angled honeycomb for rain protection or directional air flow.
- Rigidity of vent frame and enclosure so as to prevent bowing of either surface when compressing the gasket.
- Fixing requirements e.g. holes or threaded inserts ensuring appropriate position and size of hole-centres. (Holes in the corners of the frame should be avoided.)
- If specifying captive inserts in both sides of the frame off-set the positions by 10mm minimum.
- Round vents tend to be an expensive option due to the complexity of manufacturing method.
- Fully welded corners.
- Type of gasket required.
- Frame style.
- Honeycomb configuration.
- Corrosion, electrical conductivity etc, (see Finishes section)
- Weld mesh or expanded aluminium kick plates
- Removable dust filters and integral insect screens can be provided

Production Capabilities

Kemtron manufacture its range of EMC vent panels using the latest technology and, with the exception of painting and plating, all processes are kept in house, giving us flexibility and total control over quality. Kemtron has invested heavily in this area making us the market leaders for price, delivery, quality and availability

Fully programmable CNC machines for the notching & cutting of the frame extrusions and drilling of exact and repeatable holes combined with the latest TIG welding equipment allows Kemtron to offer a fast delivery of its competitive range of aluminium vent panels produced to customer designs. This advanced technology also eliminates the need for additional tooling and set-up charges. Kemtron holds a large range of aluminium extrusions and aluminium honeycomb in stock.

In addition to vent panels, Kemtron manufactures a huge range of EMI shielding products, including conductive Elastomers, oriented wire, knitted wire mesh, connector gaskets.

Vent panels made with styles 1701, 1703, 1705, 1706 & 1707 are supplied with 3 corners notched and the 4th joined corner welded and have an external corner radii of 3mm.

Product Overview (Continued)

Honeycomb specification and availability:

Kemtron uses 5052 grade aluminium foil which is a lightweight material offering superior strength and corrosion resistance over commercial grade aluminium foils. It meets all the requirements of MIL-C-7438.

Standard straight cell sizes & thicknesses held in stock

- 3.2mm (0.125") cell x 12.70mm (0.50") thick
- 3.2mm (0.125") cell x 6.35mm (0.25") thick
- 1.6mm (0.0625") cell x 6.35mm (0.25") thick
- 3.2mm (0.125") cell x 3.2mm (0.125") thick

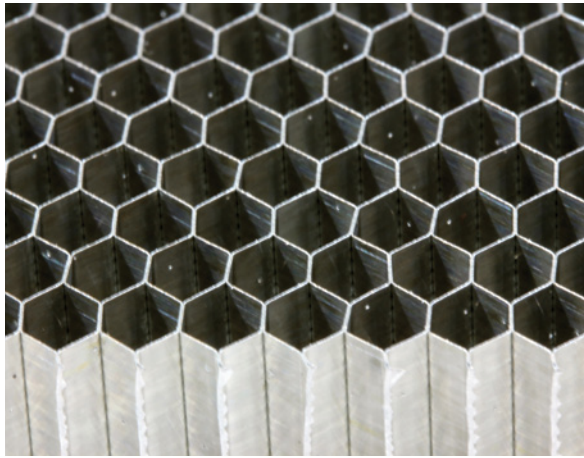

Standard slant cell sizes, angles & thicknesses held in stock

- 3.2mm (0.125") cell x 6.35mm (0.25") thick x 30°
- 3.2mm (0.125") cell x 6.35mm (0.25") thick x 45°
- 3.2mm (0.125") cell x 6.35mm (0.25") thick x 60°

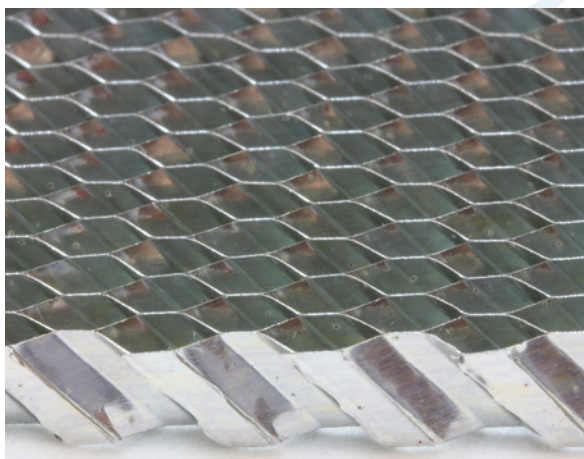

Kemtron's standard honeycomb vent uses 2 layers of $\frac{1}{8}$ " cell X $\frac{1}{4}$ " thick laid at 90°, this is known as cross cell. Cross cell honeycomb improves shielding performance by eliminating any polarizing effects.

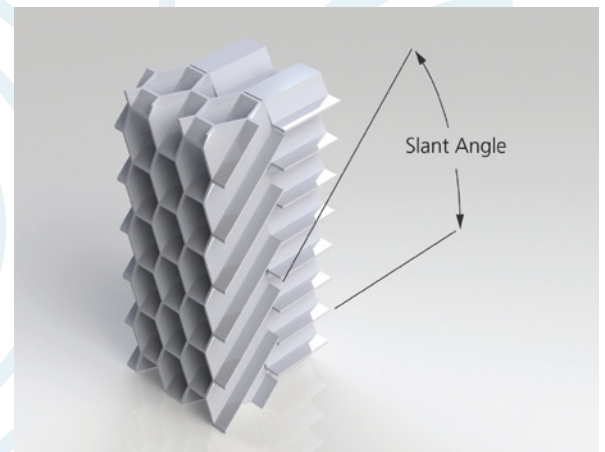
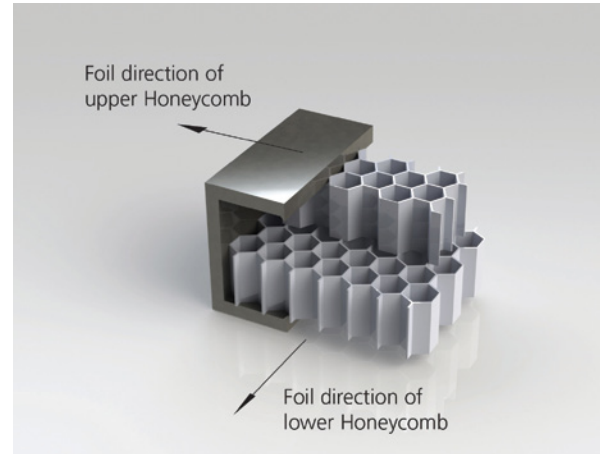

Product Overview (Continued)

Frame styles available

Frame styles 1701, 1702, 1703, 1704 and 1707 will accommodate 2 layers of 3.2 x 6.35mm thick honeycomb, one layer of 3.2mm cell x 6.35mm thick and one layer of 3.2mm x 6.35mm thick angled honeycomb or one layer 12.7mm thick honeycomb

Frame styles 1705 and 1706 will accommodate 1 layer of 3.2 or 1.6mm cell x 6.35mm thick honeycomb. Also possible to accommodate 2 layers of 3.2mm cell x 3.2mm thick honeycomb

Frame style 1709 main use is for dust filter panels that can be fitted over EMC vent panels, but can accommodate one layer of 3.2 or 1.6mm cell x 6.35mm thick honeycomb, however this is not recommended.

Frame style 1708 is a dividing/support bar for large vents.

Vents are normally supplied with three notched and one welded corner to achieve the best trade off between cost and performance. This combined with an EMC gasket is normally sufficient for all but the most demanding EMC specifications. In the event that the best possible attenuation is required all corners can be supplied fully welded. Please note that styles 1702 & 1704 are always supplied fully welded due to the nature of their construction.

Fully welded corner

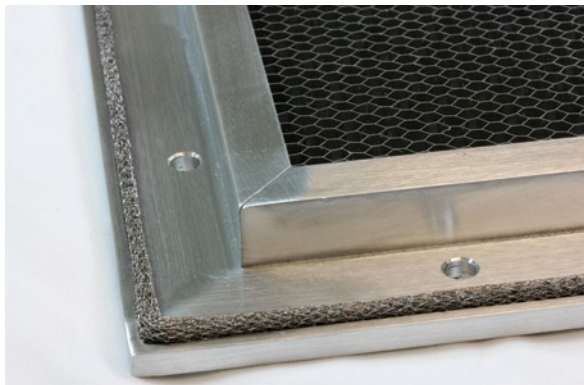

Notched corner

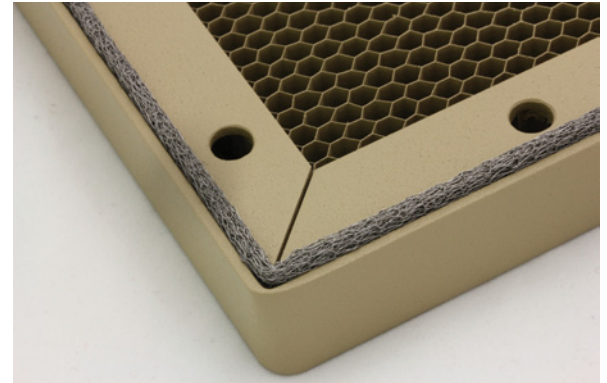

Fully welded corner

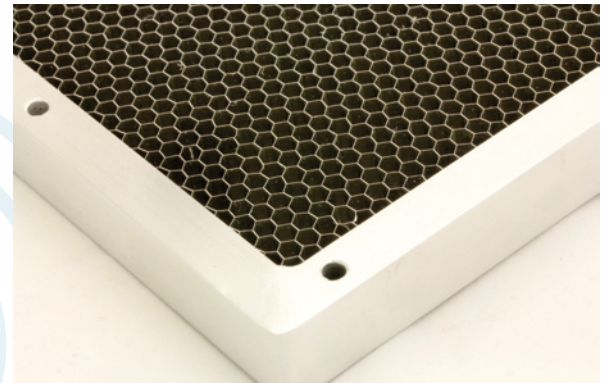

Product Overview (Continued)

Finishes

Vent panels can be supplied with a range of finishes including:

- Painted.
- Tin or nickel plating.
- Kempass (RoHS) Aluminium Passivation process.
- Trivalent chromium (RoHS compliant) or Hexavalent chromium.

Kemtron's standard finish (Kempass) for aluminium vent panels fully meets the RoHS directive and replaces Alocrom1200 which is a hexavalent chromium process. Kemtron's in-house process applies a permanganate passivation which is a chromate free, inorganic and non toxic coating. The process produces a dense, uniform coating consisting of aluminium and reduced manganese oxides giving a light yellow colour to the surface. The surface finish is conductive with a low contact resistance equalling Alocrom 1200. It also meets all requirements of MIL-C-5541E for corrosion and electrical conductivity. We are also able to offer a comprehensive range of painted finishes to complement our standard Kempass finish. Using industry leading wet paint solutions from Trimite, we offer full painting and preparation to DEF STAN specifications including matt and gloss finishes.

In addition we can also offer Infra Red Reflecting (IRR) matt finishes complying with DEF STAN 00-23, 80-166 and STANAG 2338.

For less critical / commercial applications requiring a protected finish we recommend polyester powder coating. This is tough material that offers excellent resistance to fresh and saltwater, petrol, linseed and penetrating oils, along with limited resistance to various acids. We are happy to advise on specific examples if required. As the epoxy process is an electrostatic method, it offers excellent penetration of the honeycomb cells, further aiding resistance to corrosion. With both processes, we are able to offer a full range of colours to RAL/BS charts.

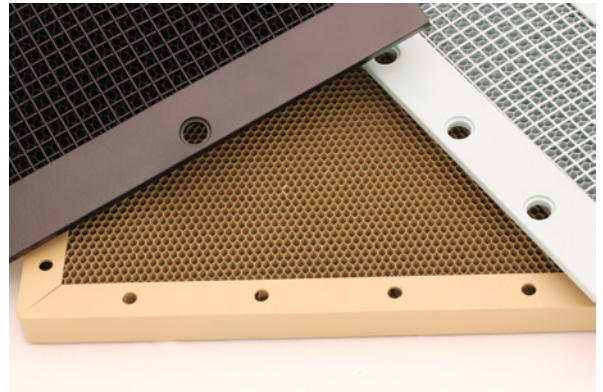

Product Overview (Continued)

Gaskets for vents

- Knitted wire mesh = Frames with a gasket groove.
- Orientated wire in silicone.
- Knitted Monel wire mesh with a Neoprene sponge carrier 2.4mm thick.
- Beryllium Copper finger stock.

Other gasket types are available if required

Beryllium copper gasket

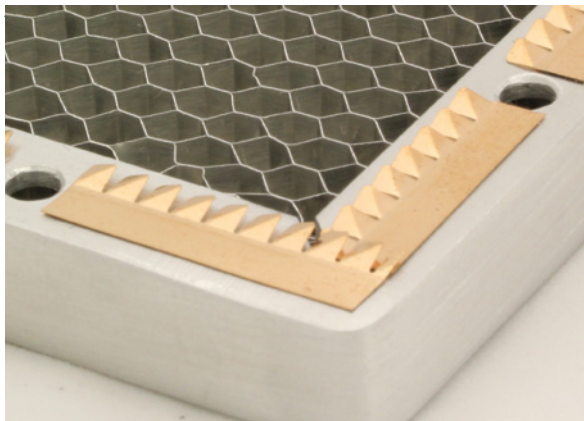

Oriented wires in silicone gasket

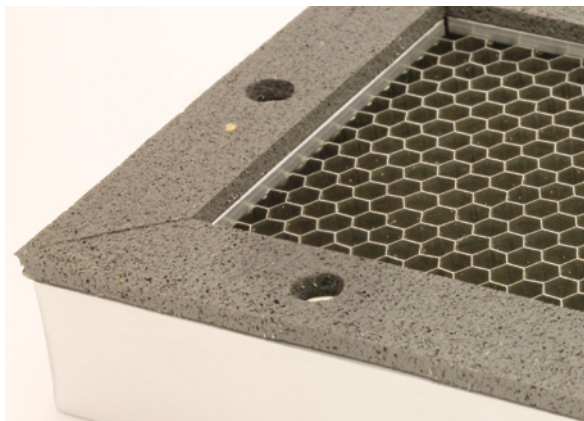

Knitted wire mesh gasket

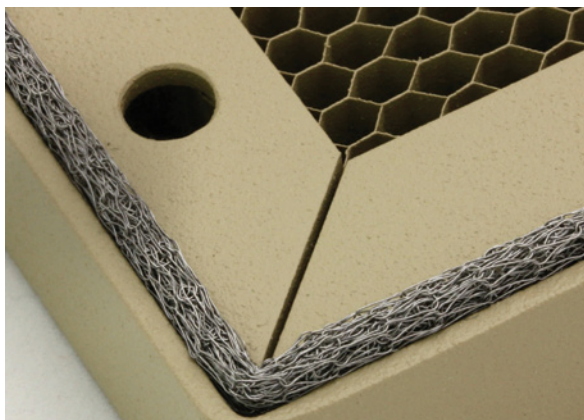

Knitted wire mesh with neoprene gasket

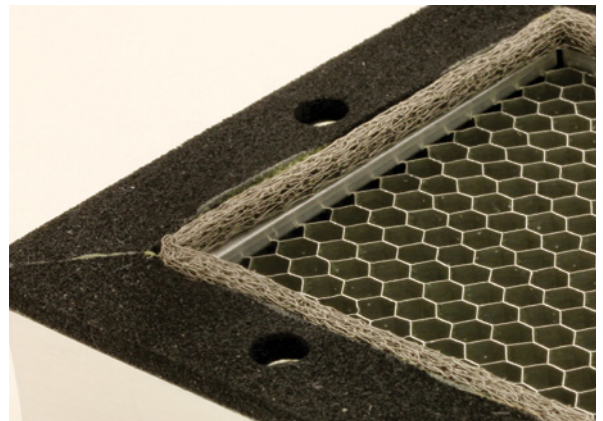

Kick Plates

Aluminium honeycomb is fragile so for high traffic areas or where honeycomb damage could easily occur kick plates can be fitted. Two types are stocked as standard, however custom designs to customers specific requirements (i.e louvred openings) are available.

Expanded aluminium provides maximum protection but reduces air flow

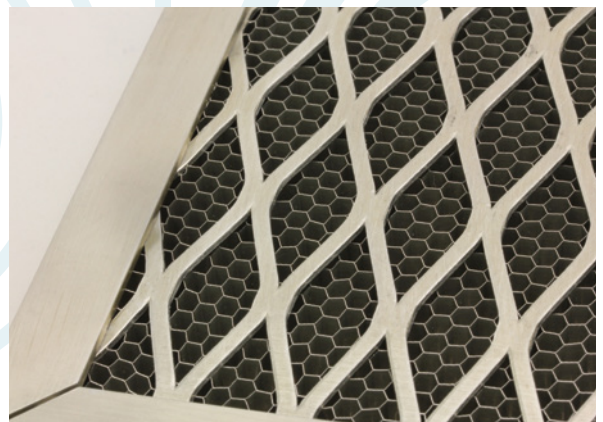

Woven stainless steel provides lower protection but higher air flow.



Product Overview (Continued)

Fan Vents

A range of low cost plastic EMC vents for use with 80mm, 92mm & 120mm fans. They provide EMC shielding where applications demand a low cost solution, whilst still providing an adequate shielding performance. A Hi-impact ABS UL94V-0 fire retardant moulding is fitted with one layer of 3.2mm cell x 6.35mm thick honeycomb and a nickel/copper fabric gasket to ground the honeycomb to the metalwork. The vents have 4 countersunk holes to suit standard fan mountings.

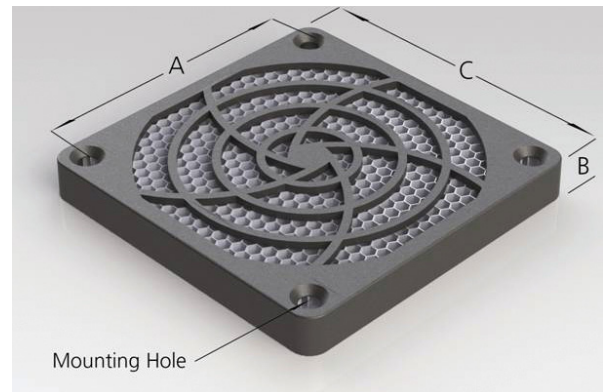

Measured shielding performance in accordance with Mil Std 285 (80mm size tested)

Frequency	Field	Typical (db)
200KHz	H	53
100MHz	E	102
500MHz	P	85
2GHz	P	74
10GHz	P	58

Type	A	B	C
Kemvent40	32.0mm	8mm	45.5mm
Kemvent60	50.0mm	9mm	66.0mm
Kemvent80	71.5mm	10mm	84.5mm
Kemvent92	82.0mm	10mm	97.0mm
Kemvent120	104.0mm	10mm	125.0mm

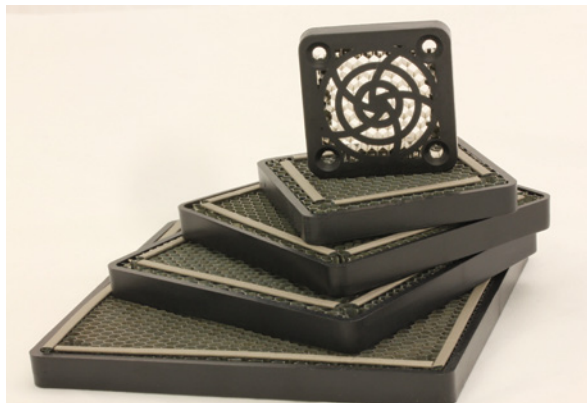

Product Overview (Continued)

Optional Removable Dust Filters and Insect Screen

Dust Filter

This consists of a aluminium frame 1701, 1705, 1706, 1707 & 1709 which holds a polyester polyurethane dust filter. This is held in place on one side by a stainless steel weld mesh. This frame then mounts on to one side of the honeycomb vent panel by captive screws. Easily removed for cleaning with a mild detergent and rinsed with water. A range of different filter options are available.

Aluminium honeycomb vent panels fitted with removable dust filters usually require assisted air flow.

Standard filter foam is stocked in two thicknesses to suit the above frame styles.

30, 45 and 60 pores per inch, others are available to meet specific requirements.



Insect Screen

This is a woven aluminium cloth inserted on one face or between the honeycomb and provides protection from the ingress of insects. Wire dia 0.28mm open area 66%.

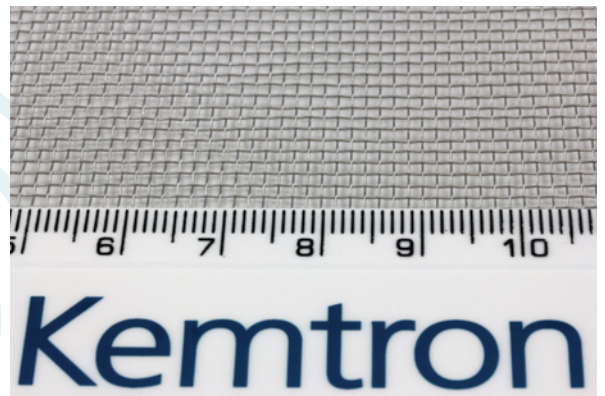

Product Overview (Continued)

Frame Styles

1701

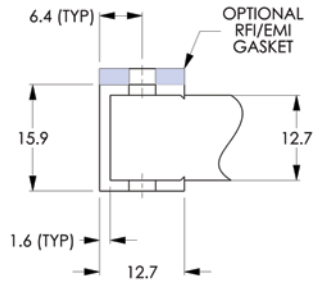

1706

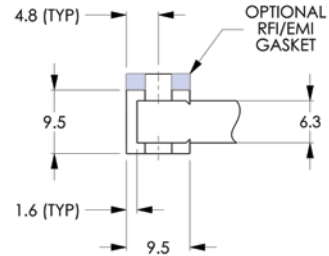

1702

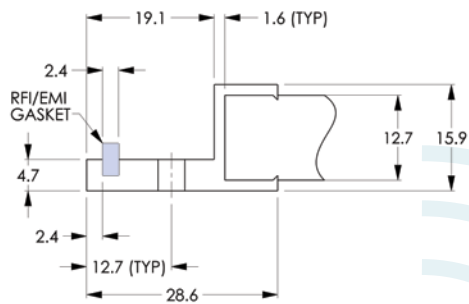

1707

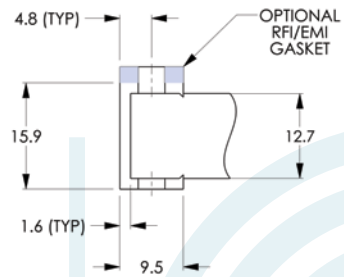

1703

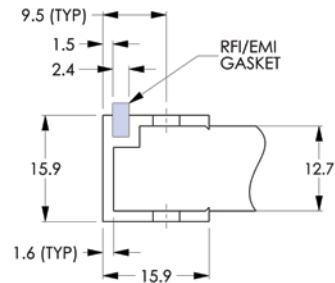

1709

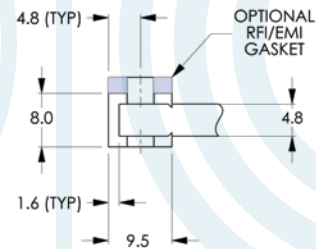

1704

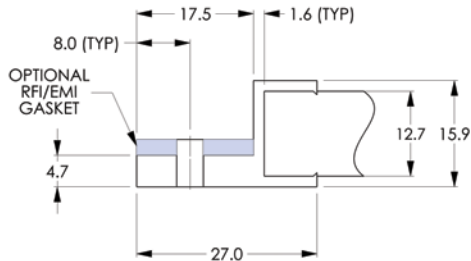

1710

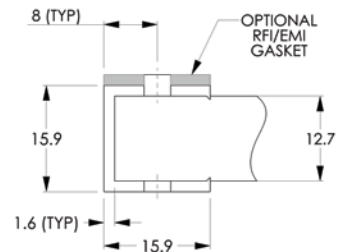

1705

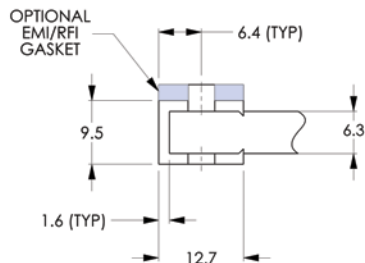

1708

Dividing/support bar

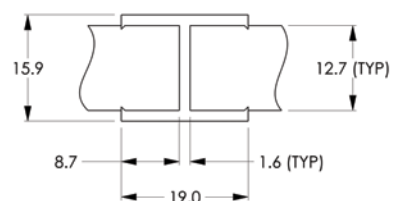

Technical Specifications

Tolerances

Standard tolerances for overall finished vent dimensions are +/- 0.8mm.

Standard tolerances on hole centres are +/- 0.4mm.

Typical corner radii on frame styles 1701, 1703, 1705, 1706 & 1707 are R3.0mm.

1702 & 1704 frame styles have square corners and are fully welded.

Specifications

Aluminium Frame	6063-T6
Aluminium Honeycomb	5052 grade
Monel Wire	BS3075 NA13
Neoprene sponge	Mil-R-6130 Type 11 grade A condition soft
Beryllium Copper	alloy 25 (CA172)
Silicone Rubber	ZZ-R-765 Class 2 Grade 40
Aluminium Wire	5056

EMC Performance (db)

Honeycomb Type

Frequency	Field	Type 1	Type 2	Type 3	Type 4	Type 5	Type 6
200kHz	H	66	39	65	71	71	78
100MHz	E	105	80	105	105	105	100
500MHz	P	81	55	50	93	93	55
2GHz	P	85	52	60	94	94	96
10GHz	P	85	61	72	82	90	80

Honeycomb

Type 1	2 layers 3.2cell x 3.2mm thick honeycomb (total 6.4mm)
Type 2	1 layer 3.2cell x 6.35mm thick honeycomb
Type 3	1 layer 1.6cell x 6.35mm thick honeycomb
Type 4	2 layers 3.2cell x 6.35mm thick honeycomb (total 12.7mm)
Type 5	1 layer 3.2cell x 6.35 thick honeycomb + 1 layer 3.2cell x 6.35mm thick slant honeycomb (total 12.7mm)
Type 6	1 layer 3.2cell x 12.7mm thick honeycomb

Honeycomb Combinations

Frame Style	Type 1	Type 2	Type 3	Type 4	Type 5	Type 6
1701				✓	✓	✓
1702				✓	✓	✓
1703				✓	✓	✓
1704				✓	✓	✓
1705	✓	✓				
1706	✓	✓				
1707				✓	✓	✓
1709		✓				

All of the above frame styles and honeycomb combinations are available with the option of a stainless steel kick-plate

Air Flow Results Graph

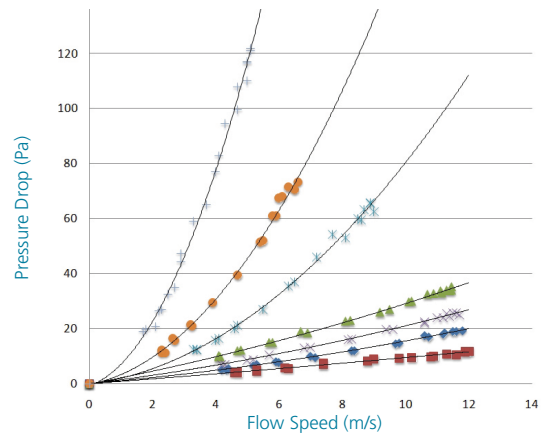

Graph Key

+	Type 5 60°
●	Type 5 45°
*	Type 5 30°
x	Type 4 & Type 6
▲	Type 3
■	Type 2
◆	Type 1

Notice

Information supplied in these data sheets is based on independent and laboratory tests which Kemtron believes to be reliable. Kemtron has no control over the design of customer's product which incorporates Kemtron's products, therefore it is the responsibility of the user to determine the suitability for his particular application and we recommend that the user make his own test to determine suitability.

The product described in this data sheet shall be of standard quality, however the products are sold without warranty of fitness for a particular purpose, either expressed or implied, except to the extent expressly stated on Kemtron's invoice, quotation or order acknowledgement. Kemtron does not warrant that products described in this data sheet will be free of conflict with existing or future patents of third parties. All risks of lack of fitness, patent infringement and the like are assumed by the user.

Technical Specifications

1701 Frames

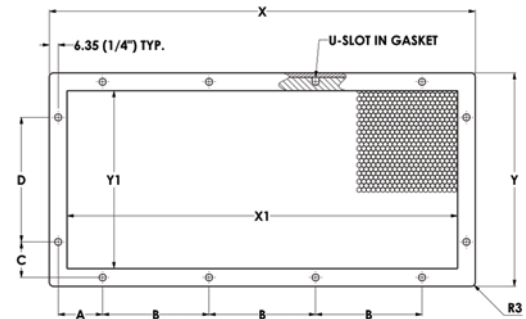
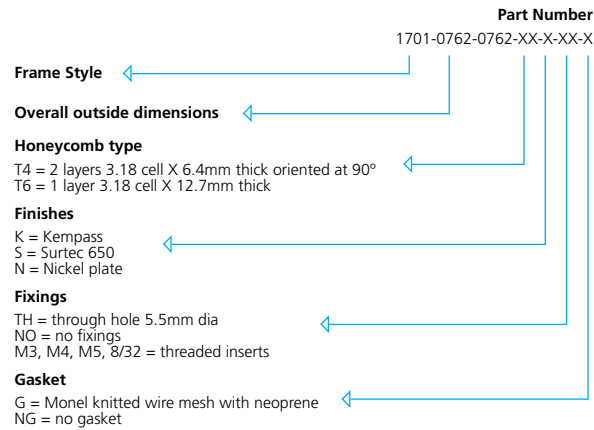

Part Number	Frame Outer Dimensions				Open Area				Open Area2		Number of Fixings		Fixing Locations							
	X		Y		X1		Y1		cm2	in.2	X	Y	A		B		C		D	
	mm	in.	mm	in.	mm	in.	mm	in.					mm	in.	mm	in.	mm	in.	mm	in.
1701-0762x0762-XXX-X-XX-X	76.2	3	76.2	3	50.8	2	50.8	2	25.8	4	1	1	31.75	1.25			31.75	1.25		
1701-1016x1016-XXX-X-XX-X	101.6	4	101.6	4	76.2	3	76.2	3	58.1	9	1	1	44.45	1.75			44.45	1.75		
1701-1524x1016-XXX-X-XX-X	152.4	6	101.6	4	127	5	76.2	3	96.8	15	2	1	25.4	1	88.9	3.5	44.45	1.75		
1701-1270x1270-XXX-X-XX-X	127	5	127	5	101.6	4	101.6	4	103.2	16	2	1	19.05	0.75	76.2	3	57.15	2.25		
1701-2032x1016-XXX-X-XX-X	203.2	8	101.6	4	177.8	7	76.2	3	135.5	21	3	1	19.05	0.75	76.2	3	44.45	1.75		
1701-1778x1270-XXX-X-XX-X	177.8	7	127	5	152.4	6	101.6	4	154.8	24	2	1	38.1	1.5	88.9	3.5	57.15	2.25		
1701-1524x1524-XXX-X-XX-X	152.4	6	152.4	6	127	5	127	5	161.3	25	2	2	25.4	1	88.9	3.5	25.4	1	88.9	3.5
1701-3048x1016-XXX-X-XX-X	304.8	12	101.6	4	279.4	11	76.2	3	212.9	33	4	1	31.75	1.25	76.2	3	44.45	1.75		
1701-2032x1524-XXX-X-XX-X	203.2	8	152.4	6	177.8	7	127	5	225.8	35	3	2	19.05	0.75	76.2	3	31.75	1.25	76.2	3
1701-1778x1778-XXX-X-XX-X	177.8	7	177.8	7	152.4	6	152.4	6	232.3	36	2	2	38.1	1.5	88.9	3.5	38.1	1.5	88.9	3.5
1701-2540x1270-XXX-X-XX-X	254	10	127	5	228.6	9	101.6	4	232.3	36	3	1	31.75	1.25	88.9	3.5	57.15	2.25		
1701-2032x2032-XXX-X-XX-X	203.2	8	203.2	8	177.8	7	177.8	7	316.1	49	3	2	19.05	0.75	76.2	3	50.8	2	88.9	3.5
1701-2540x1778-XXX-X-XX-X	254	10	177.8	7	228.6	9	152.4	6	348.4	54	3	2	31.75	1.25	88.9	3.5	38.1	1.5	88.9	3.5
1701-3048x1524-XXX-X-XX-X	304.8	12	152.4	6	279.4	11	127	5	354.8	55	4	2	31.75	1.25	76.2	3	25.4	1	88.9	3.5
1701-2540x2032-XXX-X-XX-X	254	10	203.2	8	228.6	9	177.8	7	406.5	63	3	2	31.75	1.25	88.9	3.5	50.8	2	88.9	3.5
1701-3048x2032-XXX-X-XX-X	304.8	12	203.2	8	279.4	11	177.8	7	496.8	77	4	3	31.75	1.25	76.2	3	19.05	0.75	76.2	3
1701-2540x2540-XXX-X-XX-X	254	10	254	10	228.6	9	228.6	9	522.6	81	3	3	31.75	1.25	88.9	3.5	31.75	1.25	88.9	3.5
1701-3048x3048-XXX-X-XX-X	304.8	12	304.8	12	279.4	11	279.4	11	780.6	121	4	4	31.75	1.25	76.2	3	31.75	1.25	76.2	3

Technical Specifications

1702 Frames

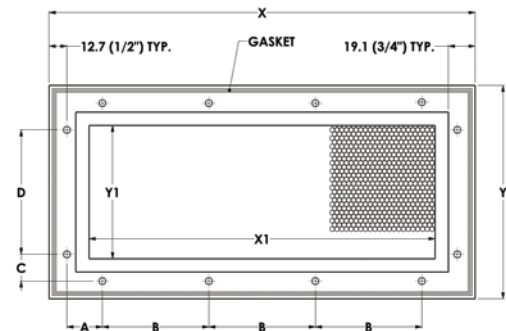
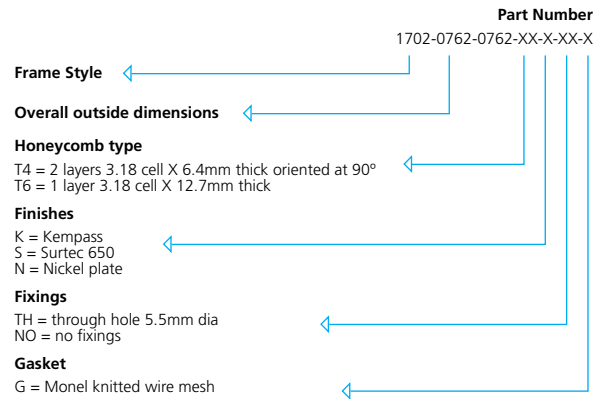

Part Number	Frame Outer Dimensions				Open Area				Open Area2		Number of Fixings		Fixing Locations							
	X		Y		X1		Y1		cm2	in.2	X	Y	A		B		C		D	
	mm	in.	mm	in.	mm	in.	mm	in.					mm	in.	mm	in.	mm	in.	mm	in.
1702-0762x0762-T4-K-TH-G	76.2	3	76.2	3	19.1	0.75	19.1	0.75	3.6	0.563	1	1	25.4	1			25.4	1		
1702-1016x1016-XXX-X-XX-G	101.6	4	101.6	4	44.5	1.75	44.5	1.75	19.8	3.063	1	1	38.1	1.5			38.1	1.5		
1702-1524x1016-XXX-X-XX-G	152.4	6	101.6	4	95.3	3.75	44.5	1.75	42.3	6.563	2	1	19.05	0.75	88.9	3.5	38.1	1.5		
1702-1270x1270-XXX-X-XX-G	127	5	127	5	69.9	2.75	69.9	2.75	48.8	7.563	2	1	12.7	0.5	76.2	3	50.8	2		
1702-2032x1016-XXX-X-XX-G	203.2	8	101.6	4	146.1	5.75	44.5	1.75	64.9	10.063	3	1	12.7	0.5	76.2	3	38.1	1.5		
1702-1778x1270-XXX-X-XX-G	177.8	7	127	5	120.7	4.75	69.9	2.75	84.3	13.063	2	1	31.75	1.25	88.9	3.5	50.8	2		
1702-1524x1524-XXX-X-XX-G	152.4	6	152.4	6	95.3	3.75	95.3	3.75	90.7	14.063	2	2	19.05	0.75	88.9	3.5	19.05	0.75	88.9	3.5
1702-3048x1016-XXX-X-XX-G	304.8	12	101.6	4	247.7	9.75	44.5	1.75	110.1	17.063	4	1	25.4	1	76.2	3	38.1	1.5		
1702-2032x1524-XXX-X-XX-G	203.2	8	152.4	6	146.1	5.75	95.3	3.75	139.1	21.563	3	2	12.7	0.5	76.2	3	25.4	1	76.2	3
1702-1778x1778-XXX-X-XX-G	177.8	7	177.8	7	120.7	4.75	120.7	4.75	145.6	22.563	2	2	31.75	1.25	88.9	3.5	31.75	1.25	88.9	3.5
1702-2540x1270-XXX-X-XX-G	254	10	127	5	196.9	7.75	69.9	2.75	137.5	21.313	3	1	25.4	1	88.9	3.5	50.8	2		
1702-2032x2032-XXX-X-XX-G	203.2	8	203.2	8	146.1	5.75	146.1	5.75	213.3	33.063	3	2	12.7	0.5	76.2	3	44.45	1.75	88.9	3.5
1702-2540x1778-XXX-X-XX-G	254	10	177.8	7	196.9	7.75	120.7	4.75	237.5	36.813	3	2	25.4	1	88.9	3.5	31.75	1.25	88.9	3.5
1702-3048x1524-XXX-X-XX-G	304.8	12	152.4	6	247.7	9.75	95.3	3.75	235.9	36.563	4	2	25.4	1	76.2	3	19.05	0.75	88.9	3.5
1702-2540x2032-XXX-X-XX-G	254	10	203.2	8	196.9	7.75	146.1	5.75	287.5	44.563	3	2	25.4	1	88.9	3.5	44.45	1.75	88.9	3.5
1702-3048x2032-XXX-X-XX-G	304.8	12	203.2	8	247.7	9.75	146.1	5.75	361.7	56.063	4	3	25.4	1	76.2	3	12.7	0.5	76.2	3
1702-2540x2540-XXX-X-XX-G	254	10	254	10	196.9	7.75	196.9	7.75	387.5	60.063	3	3	25.4	1	88.9	3.5	25.4	1	88.9	3.5
1702-3048x3048-XXX-X-XX-G	304.8	12	304.8	12	247.7	9.75	247.7	9.75	613.3	95.063	4	4	25.4	1	76.2	3	25.4	1	76.2	3

Technical Specifications

1703 Frames

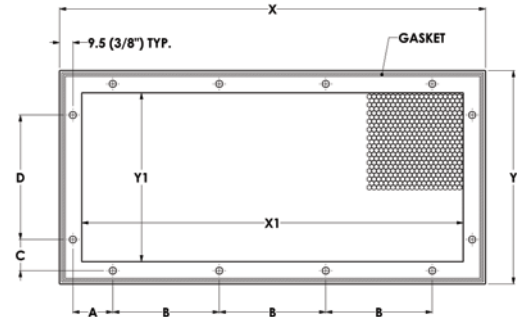
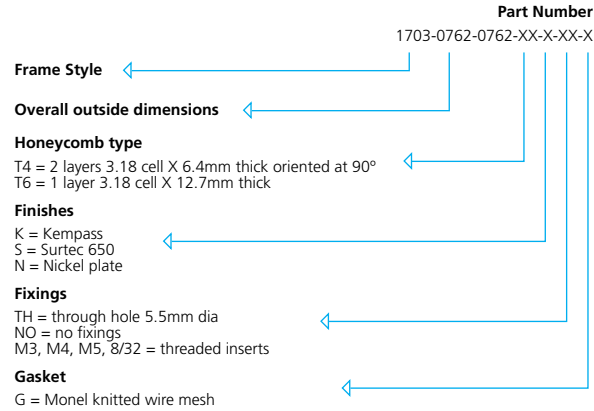

Part Number	Frame Outer Dimensions				Open Area				Open Area2		Number of Fixings		Fixing Locations							
	X		Y		X1		Y1		cm2	in.2	X	Y	A		B		C		D	
	mm	in.	mm	in.	mm	in.	mm	in.					mm	in.	mm	in.	mm	in.	mm	in.
1703-0762x0762-T4-K-TH-G	76.2	3	76.2	3	44.5	1.75	44.5	1.75	19.8	3.063	1	1	28.58	1.125			28.58	1.125		
1703-1016x1016-XXX-X-XX-G	101.6	4	101.6	4	69.9	2.75	69.9	2.75	48.8	7.563	1	1	41.28	1.625			41.28	1.625		
1703-1524x1016-XXX-X-XX-G	152.4	6	101.6	4	120.7	4.75	69.9	2.75	84.3	13.063	2	1	22.23	0.875	88.9	3.5	41.28	1.625		
1703-1270x1270-XXX-X-XX-G	127	5	127	5	95.3	3.75	95.3	3.75	90.7	14.063	2	1	15.88	0.625	76.2	3	53.98	2.125		
1703-2032x1016-XXX-X-XX-G	203.2	8	101.6	4	171.5	6.75	69.9	2.75	119.8	18.563	3	1	15.88	0.625	76.2	3	41.28	1.625		
1703-1778x1270-XXX-X-XX-G	177.8	7	127	5	146.1	5.75	95.3	3.75	139.1	21.563	2	1	34.93	1.375	88.9	3.5	53.98	2.125		
1703-1524x1524-XXX-X-XX-G	152.4	6	152.4	6	120.7	4.75	120.7	4.75	145.6	22.563	2	2	22.23	0.875	88.9	3.5	22.23	0.875	88.9	3.5
1703-3048x1016-XXX-X-XX-G	304.8	12	101.6	4	273.1	10.75	69.9	2.75	190.7	29.563	4	1	28.58	1.125	76.2	3	41.28	1.625		
1703-2032x1524-XXX-X-XX-G	203.2	8	152.4	6	171.5	6.75	120.7	4.75	206.9	32.063	3	2	15.88	0.625	76.2	3	28.58	1.125	76.2	3
1703-1778x1778-XXX-X-XX-G	177.8	7	177.8	7	146.1	5.75	146.1	5.75	213.3	33.063	2	2	34.93	1.375	88.9	3.5	34.93	1.375	88.9	3.5
1703-2540x1270-XXX-X-XX-G	254	10	127	5	222.3	8.75	95.3	3.75	211.7	32.813	3	1	28.58	1.125	88.9	3.5	53.98	2.125		
1703-2032x2032-XXX-X-XX-G	203.2	8	203.2	8	171.5	6.75	171.5	6.75	294	45.563	3	2	15.88	0.625	76.2	3	47.63	1.875	88.9	3.5
1703-2540x1778-XXX-X-XX-G	254	10	177.8	7	222.3	8.75	146.1	5.75	324.6	50.313	3	2	28.58	1.125	88.9	3.5	34.93	1.375	88.9	3.5
1703-3048x1524-XXX-X-XX-G	304.8	12	152.4	6	273.1	10.75	120.7	4.75	329.4	51.063	4	2	28.58	1.125	76.2	3	22.23	0.875	88.9	3.5
1703-2540x2032-XXX-X-XX-G	254	10	203.2	8	222.3	8.75	171.5	6.75	381	59.063	3	2	28.58	1.125	88.9	3.5	47.63	1.875	88.9	3.5
1703-3048x2032-XXX-X-XX-G	304.8	12	203.2	8	273.1	10.75	171.5	6.75	468.1	72.563	4	3	28.58	1.125	76.2	3	15.88	0.625	76.2	3
1703-2540x2540-XXX-X-XX-G	254	10	254	10	222.3	8.75	222.3	8.75	494	76.563	3	3	28.58	1.125	88.9	3.5	28.58	1.125	88.9	3.5
1703-3048x3048-XXX-X-XX-G	304.8	12	304.8	12	273.1	10.75	273.1	10.75	745.6	115.563	4	4	28.58	1.125	76.2	3	28.58	1.125	76.2	3

Technical Specifications

1704 Frames

Part Number
1704-0762-0762-XX-X-XX-X

Frame Style ←

Overall outside dimensions ←

Honeycomb type
 T4 = 2 layers 3.18 cell X 6.4mm thick oriented at 90°
 T6 = 1 layer 3.18 cell X 12.7mm thick

Finishes
 K = Kempass
 S = Surttec 650
 N = Nickel plate

Fixings
 TH = through hole 5.5mm dia
 NO = no fixings

Gasket
 G = Monel knitted wire mesh with neoprene
 NG = no gasket

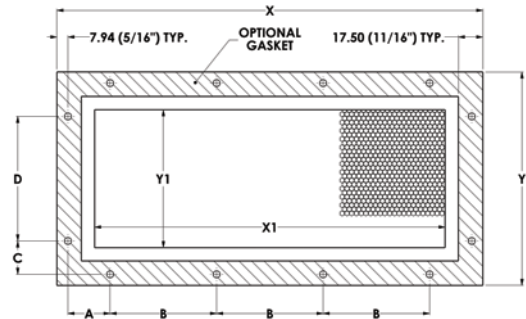

Part Number	Frame Outer Dimensions				Open Area				Open Area2		Number of Fixings		Fixing Locations								
	X		Y		X1		Y1		cm2	in.2	X	Y	A		B		C		D		
	mm	in.	mm	in.	mm	in.	mm	in.					mm	in.	mm	in.	mm	in.	mm	in.	
1701-0762x0762-T4-K-TH-G																					
1704-0762x0762-XXX-X-XX-X	76.2	3	76.2	3	22.2	0.875	22.2	0.875	4.9	0.766	1	1	30.16	1.187			30.16	1.187			
1704-1016x1016-XXX-X-XX-X	101.6	4	101.6	4	47.6	1.875	47.6	1.875	22.7	3.515	1	1	42.86	1.687			42.86	1.687			
1704-1524x1016-XXX-X-XX-X	152.4	6	101.6	4	98.4	3.875	47.6	1.875	46.9	7.265	2	1	23.81	0.937	88.9	3.5	42.86	1.687			
1704-1270x1270-XXX-X-XX-X	127	5	127	5	73	2.875	73	2.875	53.3	8.265	2	1	17.46	0.687	76.2	3	55.56	2.187			
1704-2032x1016-XXX-X-XX-X	203.2	8	101.6	4	149.2	5.875	47.6	1.875	71.1	11.015	3	1	17.46	0.687	76.2	3	42.86	1.687			
1704-1778x1270-XXX-X-XX-X	177.8	7	127	5	123.8	4.875	73	2.875	90.4	14.015	2	1	36.51	1.437	88.9	3.5	55.56	2.187			
1704-1524x1524-XXX-X-XX-X	152.4	6	152.4	6	98.4	3.875	98.4	3.875	96.9	15.015	2	2	23.81	0.937	88.9	3.5	23.81	0.937	88.9	3.5	
1704-3048x1016-XXX-X-XX-X	304.8	12	101.6	4	250.8	9.875	47.6	1.875	119.5	18.515	4	1	30.16	1.187	76.2	3	42.86	1.687			
1704-2032x1524-XXX-X-XX-X	203.2	8	152.4	6	149.2	5.875	98.4	3.875	146.9	22.765	3	2	17.46	0.687	76.2	3	30.16	1.187	76.2	3	
1704-1778x1778-XXX-X-XX-X	177.8	7	177.8	7	123.8	4.875	123.8	4.875	153.3	23.765	2	2	36.51	1.437	88.9	3.5	36.51	1.437	88.9	3.5	
1704-2540x1270-XXX-X-XX-X	254	10	127	5	200	7.875	73	2.875	146.1	22.64	3	1	30.16	1.187	88.9	3.5	55.56	2.187			
1704-2032x2032-XXX-X-XX-X	203.2	8	203.2	8	149.2	5.875	149.2	5.875	222.7	34.515	3	2	17.46	0.687	76.2	3	49.21	1.937	88.9	3.5	
1704-2540x1778-XXX-X-XX-X	254	10	177.8	7	200	7.875	123.8	4.875	247.7	38.39	3	2	30.16	1.187	88.9	3.5	36.51	1.437	88.9	3.5	
1704-3048x1524-XXX-X-XX-X	304.8	12	152.4	6	250.8	9.875	98.4	3.875	246.9	38.265	4	2	30.16	1.187	76.2	3	23.81	0.937	88.9	3.5	
1704-2540x2032-XXX-X-XX-X	254	10	203.2	8	200	7.875	149.2	5.875	298.5	46.265	3	2	30.16	1.187	88.9	3.5	49.21	1.937	88.9	3.5	
1704-3048x2032-XXX-X-XX-X	304.8	12	203.2	8	250.8	9.875	149.2	5.875	374.3	58.015	4	3	30.16	1.187	76.2	3	17.46	0.687	76.2	3	
1704-2540x2540-XXX-X-XX-X	254	10	254	10	200	7.875	200	7.875	400.1	62.015	3	3	30.16	1.187	88.9	3.5	30.16	1.187	88.9	3.5	
1704-3048x3048-XXX-X-XX-X	304.8	12	304.8	12	250.8	9.875	250.8	9.875	629.1	97.515	4	4	30.16	1.187	76.2	3	30.16	1.187	76.2	3	

Technical Specifications

1705 Frames

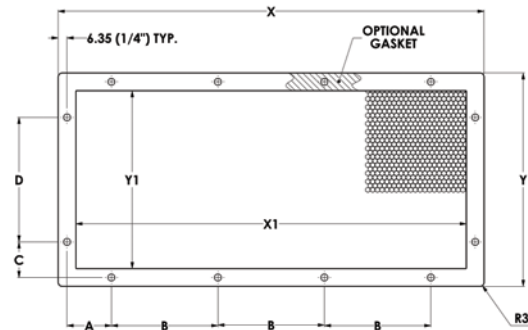
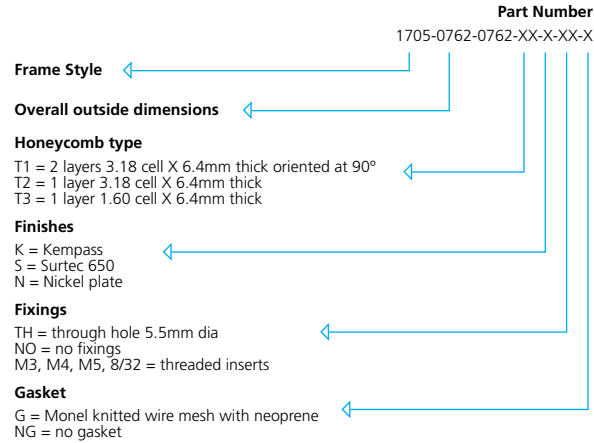

Part Number	Frame Outer Dimensions				Open Area				Open Area2		Number of Fixings		Fixing Locations							
	X		Y		X1		Y1		cm2	in.2	X	Y	A		B		C		D	
	mm	in.	mm	in.	mm	in.	mm	in.					mm	in.	mm	in.	mm	in.	mm	in.
1705-0762x0762-XXX-X-XX-X	76.2	3	76.2	3	50.8	2	50.8	2	25.8	4	1	1	31.75	1.25			31.75	1.25		
1705-1016x1016-XXX-X-XX-X	101.6	4	101.6	4	76.2	3	76.2	3	58.1	9	1	1	44.45	1.75			44.45	1.75		
1705-1524x1016-XXX-X-XX-X	152.4	6	101.6	4	127	5	76.2	3	96.8	15	2	1	25.4	1	88.9	3.5	44.45	1.75		
1705-1270x1270-XXX-X-XX-X	127	5	127	5	101.6	4	101.6	4	103.2	16	2	1	19.05	0.75	76.2	3	57.15	2.25		
1705-2032x1016-XXX-X-XX-X	203.2	8	101.6	4	177.8	7	76.2	3	135.5	21	3	1	19.05	0.75	76.2	3	44.45	1.75		
1705-1778x1270-XXX-X-XX-X	177.8	7	127	5	152.4	6	101.6	4	154.8	24	2	1	38.1	1.5	88.9	3.5	57.15	2.25		
1705-1524x1524-XXX-X-XX-X	152.4	6	152.4	6	127	5	127	5	161.3	25	2	2	25.4	1	88.9	3.5	25.4	1	88.9	3.5
1705-3048x1016-XXX-X-XX-X	304.8	12	101.6	4	279.4	11	76.2	3	212.9	33	4	1	31.75	1.25	76.2	3	44.45	1.75		
1705-2032x1524-XXX-X-XX-X	203.2	8	152.4	6	177.8	7	127	5	225.8	35	3	2	19.05	0.75	76.2	3	31.75	1.25	76.2	3
1705-1778x1778-XXX-X-XX-X	177.8	7	177.8	7	152.4	6	152.4	6	232.3	36	2	2	38.1	1.5	88.9	3.5	38.1	1.5	88.9	3.5
1705-2540x1270-XXX-X-XX-X	254	10	127	5	228.6	9	101.6	4	232.3	36	3	1	31.75	1.25	88.9	3.5	57.15	2.25		
1705-2032x2032-XXX-X-XX-X	203.2	8	203.2	8	177.8	7	177.8	7	316.1	49	3	2	19.05	0.75	76.2	3	50.8	2	88.9	3.5
1705-2540x1778-XXX-X-XX-X	254	10	177.8	7	228.6	9	152.4	6	348.4	54	3	2	31.75	1.25	88.9	3.5	38.1	1.5	88.9	3.5
1705-3048x1524-XXX-X-XX-X	304.8	12	152.4	6	279.4	11	127	5	354.8	55	4	2	31.75	1.25	76.2	3	25.4	1	88.9	3.5
1705-2540x2032-XXX-X-XX-X	254	10	203.2	8	228.6	9	177.8	7	406.5	63	3	2	31.75	1.25	88.9	3.5	50.8	2	88.9	3.5
1705-3048x2032-XXX-X-XX-X	304.8	12	203.2	8	279.4	11	177.8	7	496.8	77	4	3	31.75	1.25	76.2	3	19.05	0.75	76.2	3
1705-2540x2540-XXX-X-XX-X	254	10	254	10	228.6	9	228.6	9	522.6	81	3	3	31.75	1.25	88.9	3.5	31.75	1.25	88.9	3.5
1705-3048x3048-XXX-X-XX-X	304.8	12	304.8	12	279.4	11	279.4	11	780.6	121	4	4	31.75	1.25	76.2	3	31.75	1.25	76.2	3

Technical Specifications

1706 Frames

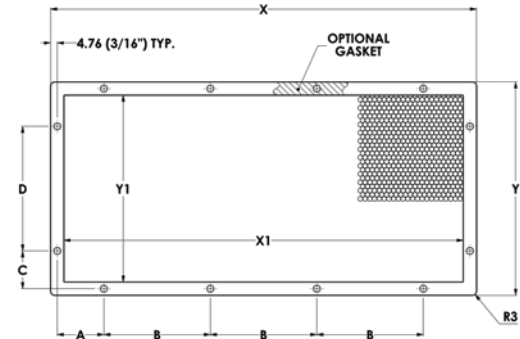
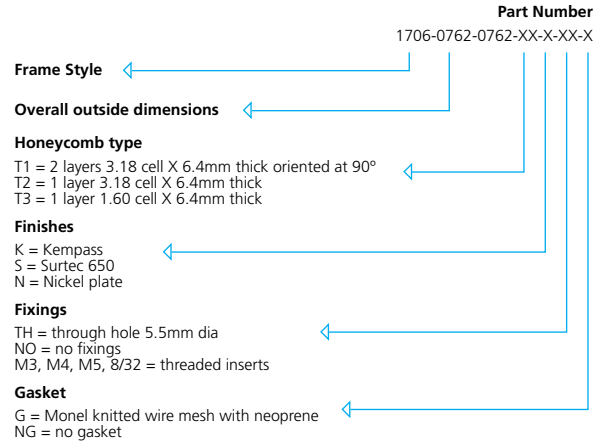

Part Number	Frame Outer Dimensions				Open Area				Open Area2		Number of Fixings		Fixing Locations							
	X		Y		X1		Y1		cm2	in.2	X	Y	A		B		C		D	
	mm	in.	mm	in.	mm	in.	mm	in.					mm	in.	mm	in.	mm	in.	mm	in.
1706-0762x0762-XXX-X-XX-X	76.2	3	76.2	3	57.2	2	57.2	2	32.7	5	1	1	33.34	1.313			33.34	1.313		
1706-1016x1016-XXX-X-XX-X	101.6	4	101.6	4	82.6	3	82.6	3	68.1	11	1	1	46.04	1.813			46.04	1.813		
1706-1524x1016-XXX-X-XX-X	152.4	6	101.6	4	133.4	5	82.6	3	110.1	17	2	1	26.99	1.063	88.9	3.5	46.04	1.813		
1706-1270x1270-XXX-X-XX-X	127	5	127	5	108	4	108	4	116.5	18	2	1	20.64	0.813	76.2	3	58.74	2.313		
1706-2032x1016-XXX-X-XX-X	203.2	8	101.6	4	184.2	7	82.6	3	152	24	3	1	20.64	0.813	76.2	3	46.04	1.813		
1706-1778x1270-XXX-X-XX-X	177.8	7	127	5	158.8	6	108	4	171.4	27	2	1	39.69	1.563	88.9	3.5	58.74	2.313		
1706-1524x1524-XXX-X-XX-X	152.4	6	152.4	6	133.4	5	133.4	5	177.8	28	2	2	26.99	1.063	88.9	3.5	26.99	1.063	88.9	3.5
1706-3048x1016-XXX-X-XX-X	304.8	12	101.6	4	285.8	11	82.6	3	235.9	37	4	1	33.34	1.313	76.2	3	46.04	1.813		
1706-2032x1524-XXX-X-XX-X	203.2	8	152.4	6	184.2	7	133.4	5	245.6	38	3	2	20.64	0.813	76.2	3	33.34	1.313	76.2	3
1706-1778x1778-XXX-X-XX-X	177.8	7	177.8	7	158.8	6	158.8	6	252	39	2	2	39.69	1.563	88.9	3.5	39.69	1.563	88.9	3.5
1706-2540x1270-XXX-X-XX-X	254	10	127	5	235	9	108	4	253.6	39	3	1	33.34	1.313	88.9	3.5	58.74	2.313		
1706-2032x2032-XXX-X-XX-X	203.2	8	203.2	8	184.2	7	184.2	7	339.1	53	3	2	20.64	0.813	76.2	3	52.39	2.063	88.9	3.5
1706-2540x1778-XXX-X-XX-X	254	10	177.8	7	235	9	158.8	6	373	58	3	2	33.34	1.313	88.9	3.5	39.69	1.563	88.9	3.5
1706-3048x1524-XXX-X-XX-X	304.8	12	152.4	6	285.8	11	133.4	5	381	59	4	2	33.34	1.313	76.2	3	26.99	1.063	88.9	3.5
1706-2540x2032-XXX-X-XX-X	254	10	203.2	8	235	9	184.2	7	432.7	67	3	2	33.34	1.313	88.9	3.5	52.39	2.063	88.9	3.5
1706-3048x2032-XXX-X-XX-X	304.8	12	203.2	8	285.8	11	184.2	7	526.2	82	4	3	33.34	1.313	76.2	3	20.64	0.813	76.2	3
1706-2540x2540-XXX-X-XX-X	254	10	254	10	235	9	235	9	552	86	3	3	33.34	1.313	88.9	3.5	33.34	1.313	88.9	3.5
1706-3048x3048-XXX-X-XX-X	304.8	12	304.8	12	285.8	11	285.8	11	816.5	127	4	4	33.34	1.313	76.2	3	33.34	1.313	76.2	3

Technical Specifications

1707 Frames

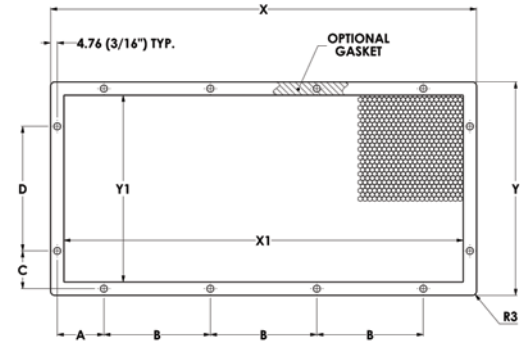
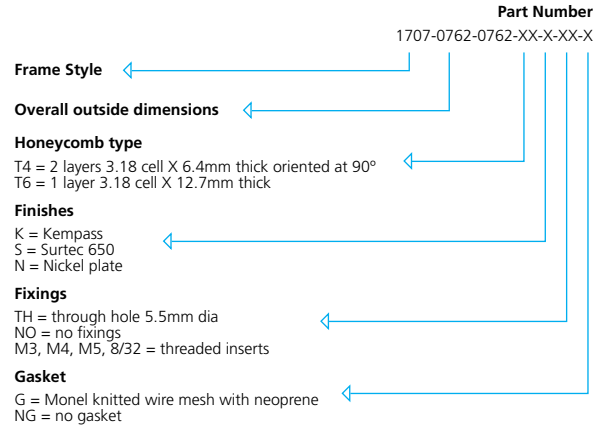

Part Number	Frame Outer Dimensions				Open Area				Open Area2		Number of Fixings		Fixing Locations							
	X		Y		X1		Y1		cm2	in.2	X	Y	A		B		C		D	
	mm	in.	mm	in.	mm	in.	mm	in.					mm	in.	mm	in.	mm	in.	mm	in.
1707-0762x0762-T4-K-TH-G	76.2	3	76.2	3	57.2	2	57.2	2	32.7	5	1	1	33.34	1.313			33.34	1.313		
1707-1016x1016-XXX-X-XX-X	101.6	4	101.6	4	82.6	3	82.6	3	68.1	11	1	1	46.04	1.813			46.04	1.813		
1707-1524x1016-XXX-X-XX-X	152.4	6	101.6	4	133.4	5	82.6	3	110.1	17	2	1	26.99	1.063	88.9	3.5	46.04	1.813		
1707-1270x1270-XXX-X-XX-X	127	5	127	5	108	4	108	4	116.5	18	2	1	20.64	0.813	76.2	3	58.74	2.313		
1707-2032x1016-XXX-X-XX-X	203.2	8	101.6	4	184.2	7	82.6	3	152	24	3	1	20.64	0.813	76.2	3	46.04	1.813		
1707-1778x1270-XXX-X-XX-X	177.8	7	127	5	158.8	6	108	4	171.4	27	2	1	39.69	1.563	88.9	3.5	58.74	2.313		
1707-1524x1524-XXX-X-XX-X	152.4	6	152.4	6	133.4	5	133.4	5	177.8	28	2	2	26.99	1.063	88.9	3.5	26.99	1.063	88.9	3.5
1707-3048x1016-XXX-X-XX-X	304.8	12	101.6	4	285.8	11	82.6	3	235.9	37	4	1	33.34	1.313	76.2	3	46.04	1.813		
1707-2032x1524-XXX-X-XX-X	203.2	8	152.4	6	184.2	7	133.4	5	245.6	38	3	2	20.64	0.813	76.2	3	33.34	1.313	76.2	3
1707-1778x1778-XXX-X-XX-X	177.8	7	177.8	7	158.8	6	158.8	6	252	39	2	2	39.69	1.563	88.9	3.5	39.69	1.563	88.9	3.5
1707-2540x1270-XXX-X-XX-X	254	10	127	5	235	9	108	4	253.6	39	3	1	33.34	1.313	88.9	3.5	58.74	2.313		
1707-2032x2032-XXX-X-XX-X	203.2	8	203.2	8	184.2	7	184.2	7	339.1	53	3	2	20.64	0.813	76.2	3	52.39	2.063	88.9	3.5
1707-2540x1778-XXX-X-XX-X	254	10	177.8	7	235	9	158.8	6	373	58	3	2	33.34	1.313	88.9	3.5	39.69	1.563	88.9	3.5
1707-3048x1524-XXX-X-XX-X	304.8	12	152.4	6	285.8	11	133.4	5	381	59	4	2	33.34	1.313	76.2	3	26.99	1.063	88.9	3.5
1707-2540x2032-XXX-X-XX-X	254	10	203.2	8	235	9	184.2	7	432.7	67	3	2	33.34	1.313	88.9	3.5	52.39	2.063	88.9	3.5
1707-3048x2032-XXX-X-XX-X	304.8	12	203.2	8	285.8	11	184.2	7	526.2	82	4	3	33.34	1.313	76.2	3	20.64	0.813	76.2	3
1707-2540x2540-XXX-X-XX-X	254	10	254	10	235	9	235	9	552	86	3	3	33.34	1.313	88.9	3.5	33.34	1.313	88.9	3.5
1707-3048x3048-XXX-X-XX-X	304.8	12	304.8	12	285.8	11	285.8	11	816.5	127	4	4	33.34	1.313	76.2	3	33.34	1.313	76.2	3

Technical Specifications

1709 Frames

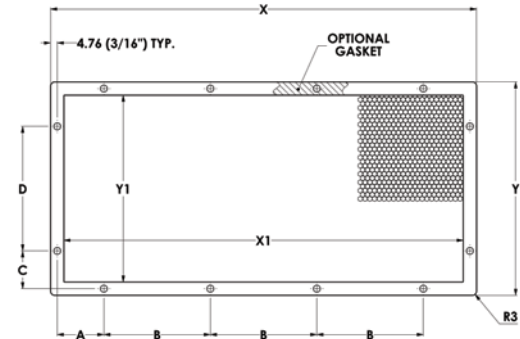
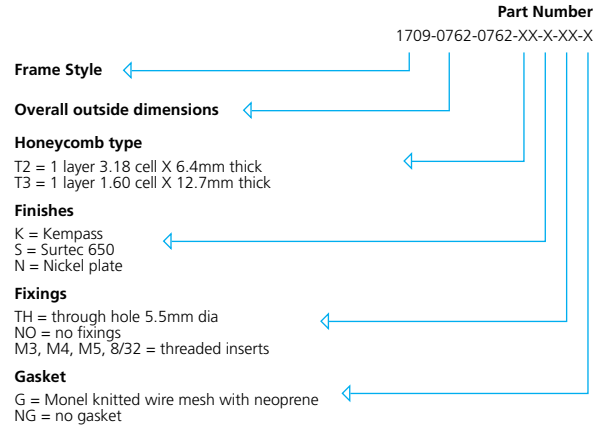

Part Number	Frame Outer Dimensions				Open Area				Open Area2		Number of Fixings		Fixing Locations								
	X		Y		X1		Y1		cm2	in.2	X	Y	A		B		C		D		
	mm	in.	mm	in.	mm	in.	mm	in.					mm	in.	mm	in.	mm	in.	mm	in.	
1709-0762x0762-T4-K-TH-G																					
1709-0762x0762-XXX-X-XX-X	76.2	3	76.2	3	57.2	2	57.2	2	32.7	5	1	1	33.34	1.313			33.34	1.313			
1709-1016x1016-XXX-X-XX-X	101.6	4	101.6	4	82.6	3	82.6	3	68.1	11	1	1	46.04	1.813			46.04	1.813			
1709-1524x1016-XXX-X-XX-X	152.4	6	101.6	4	133.4	5	82.6	3	110.1	17	2	1	26.99	1.063	88.9	3.5	46.04	1.813			
1709-1270x1270-XXX-X-XX-X	127	5	127	5	108	4	108	4	116.5	18	2	1	20.64	0.813	76.2	3	58.74	2.313			
1709-2032x1016-XXX-X-XX-X	203.2	8	101.6	4	184.2	7	82.6	3	152	24	3	1	20.64	0.813	76.2	3	46.04	1.813			
1709-1778x1270-XXX-X-XX-X	177.8	7	127	5	158.8	6	108	4	171.4	27	2	1	39.69	1.563	88.9	3.5	58.74	2.313			
1709-1524x1524-XXX-X-XX-X	152.4	6	152.4	6	133.4	5	133.4	5	177.8	28	2	2	26.99	1.063	88.9	3.5	26.99	1.063	88.9	3.5	
1709-3048x1016-XXX-X-XX-X	304.8	12	101.6	4	285.8	11	82.6	3	235.9	37	4	1	33.34	1.313	76.2	3	46.04	1.813			
1709-2032x1524-XXX-X-XX-X	203.2	8	152.4	6	184.2	7	133.4	5	245.6	38	3	2	20.64	0.813	76.2	3	33.34	1.313	76.2	3	
1709-1778x1778-XXX-X-XX-X	177.8	7	177.8	7	158.8	6	158.8	6	252	39	2	2	39.69	1.563	88.9	3.5	39.69	1.563	88.9	3.5	
1709-2540x1270-XXX-X-XX-X	254	10	127	5	235	9	108	4	253.6	39	3	1	33.34	1.313	88.9	3.5	58.74	2.313			
1709-2032x2032-XXX-X-XX-X	203.2	8	203.2	8	184.2	7	184.2	7	339.1	53	3	2	20.64	0.813	76.2	3	52.39	2.063	88.9	3.5	
1709-2540x1778-XXX-X-XX-X	254	10	177.8	7	235	9	158.8	6	373	58	3	2	33.34	1.313	88.9	3.5	39.69	1.563	88.9	3.5	
1709-3048x1524-XXX-X-XX-X	304.8	12	152.4	6	285.8	11	133.4	5	381	59	4	2	33.34	1.313	76.2	3	26.99	1.063	88.9	3.5	
1709-2540x2032-XXX-X-XX-X	254	10	203.2	8	235	9	184.2	7	432.7	67	3	2	33.34	1.313	88.9	3.5	52.39	2.063	88.9	3.5	
1709-3048x2032-XXX-X-XX-X	304.8	12	203.2	8	285.8	11	184.2	7	526.2	82	4	3	33.34	1.313	76.2	3	20.64	0.813	76.2	3	
1709-2540x2540-XXX-X-XX-X	254	10	254	10	235	9	235	9	552	86	3	3	33.34	1.313	88.9	3.5	33.34	1.313	88.9	3.5	
1709-3048x3048-XXX-X-XX-X	304.8	12	304.8	12	285.8	11	285.8	11	816.5	127	4	4	33.34	1.313	76.2	3	33.34	1.313	76.2	3	