



# Enclosures



### Did you know that iLECSYS offer an extensive range of engineering services?

iLECSYS can provide expert design and engineering services for your business.

We have a wide range of fabrication services including; precision CNC machining, punching, folding and milling, all types of welding, including tight limit fabrication. We are also able to offer high quality finishing processes, screen printing and assembly. We can manage one-off projects or large quantity orders with ease, ensuring your product is modified with repeat precision.

Need a CAD drawing for your modification or require a bespoke product? Call our in-house design team who will be happy to discuss your requirements.

**Engineering • Fabrication • Milling • Welding  
Forming • Folding • Screen Printing • Finishing**

For more information or to discuss an upcoming project please call us now on **01844 397300** or email [sales@ilecsys.co.uk](mailto:sales@ilecsys.co.uk)

### What is an IP rating?

An IP (Ingress Protection) rating is defined in the International Standard EN 60529 (British BS EN 60529:1992, European IEC 60509:1989). An IP rating is used to define levels of sealing effectiveness of electrical enclosures against intrusion from foreign bodies (tools, dirt, dust etc) and moisture.

### What do the numbers of an IP rating mean?

The digits that follow IP, indicate conformity with the conditions summarised in the tables below. The first digit of the IP code indicates the degree that persons are protected against contact with live or moving parts and the degree that equipment is protected against solid foreign bodies intruding into an enclosure. The second digit indicates the degree of protection of the equipment inside the enclosure against the harmful entry of various forms of moisture (e.g. dripping, spraying, submersion, etc).

#### First Number: Solid Bodies

<b>X</b>		Protection Unspecified.
<b>0</b>		No protection.
<b>1</b>		Protected against a solid object greater than 50mm such as a hand.
<b>2</b>		Protected against a solid object greater than 12.5 mm such as a finger.
<b>3</b>		Protected against a solid object greater than 2.5 mm such as a screwdriver.
<b>4</b>		Protected against a solid object greater than 1 mm such as wire.
<b>5</b>		Dust Protected. Limited ingress of dust permitted. Will not interfere with operation of the equipment. Two to eight hours.
<b>6</b>		Dust Tight. No ingress of dust. Two to eight hours.

#### Second Number: Liquids

<b>X</b>		Protection Unspecified.
<b>0</b>		No protection.
<b>1</b>		Protected against vertically falling drops of water. Limited ingress permitted.
<b>2</b>		Protected against vertically falling drops of water with enclosure tilted up to 15 degrees from the vertical. Limited ingress permitted.
<b>3</b>		Protected against sprays of water up to 60 degrees from the vertical. Limited ingress permitted for three minutes.
<b>4</b>		Protected against water splashed from all directions. Limited ingress permitted.
<b>5</b>		Protected against jets of water. Limited ingress permitted.
<b>6</b>		Water from heavy seas or water projected in powerful jets shall not enter the enclosure in harmful quantities.
<b>7</b>		Protection against the effects of immersion in water between 15 cm and 1 m for 30 minutes.
<b>8</b>		Protection against the effects of immersion in water under pressure for long periods.
<b>9K</b>		Protection against high pressure and high temperature water jets.

#### Rating Example:

**IP65**

INGRESS PROTECTION

**Mild Steel Wall Mounting Enclosures**

**Mild Steel Wall Mounting**

Schneider NSYS3D	12-15
Schneider NSYCRN	16-19
Schneider NSYS3DM	20-21
Eldon MAS/MAD	22-24

**Mild Steel Terminal Boxes**

Schneider NSYSBM	26-27
Eldon STB	28



**Mild Steel Floor Standing Enclosures & Consoles**

**Mild Steel Floor Standing**

Schneider NSYSM	54-55
Schneider NSYSF	56-59
Eldon MKS/MKD	60-61
Eldon MCS/MCD	62-65

**Mild Steel Consoles**

Eldon MPG	25
-----------	----



**Stainless Steel Enclosures**

**Stainless Steel Wall Mounting**

Schneider NSYS3X	30-31
Eldon ASR/AFS	32-33

**Stainless Steel Terminal Boxes**

Eldon SSTB	29
------------	----

**Stainless Steel Floor Standing**

Eldon EKSS	66
Schneider NSYSMX	67



**GRP & Polycarbonate Wall Mounting Enclosures**

**GRP Wall Mounting Enclosures**

Schneider NSYPLMG	34-37
Pedro	40-41
Cahors Minipol	48-49

**Polycarbonate Wall Mounting Enclosures**

Fibox ARCA	38-39
Ensto Polybox	80-81
Fibox CAB	90-91



**GRP Floor Standing Enclosures**

**GRP Floor Standing Enclosures**

Schneider NSYPLAG	42-46
Roadside & Electricity Meters	47



**GRP Industrial with Screw Lid**

**GRP Industrial Screw Lid**

Cahors Combiester	50-51
Schneider NSYPLSG	52-53
Connect Euronorm Polyester	102



**Polycarbonate/ABS Enclosures**

**Polycarbonate/ABS Hinged Lid**

Fibox ARCA	38-39
Ensto Polybox	80-81
Ensto Cubo W	78-79
Fibox CAB	90-91

**Polycarbonate/ABS Screw Lid**

Ensto Cubo S	68-73
Ensto Cubo D	74-75
Ensto Cubo O	76-77
Fibox Piccolo	82
Fibox MNX	84-85
Fibox Solid	86-87
Fibox EK	88-89
Fibox Tempo	83



**Plastic Junction Boxes**

**Plastic Junction Boxes**

Schneider DPN Junction Boxes	92
Schneider NSYTBS Universal Boxes	93
Pico Junction Boxes	94
Gewiss Junction Boxes	95

**Small Terminal Boxes**

Wiska Combi	96-97
Spelsberg A Box	98-99

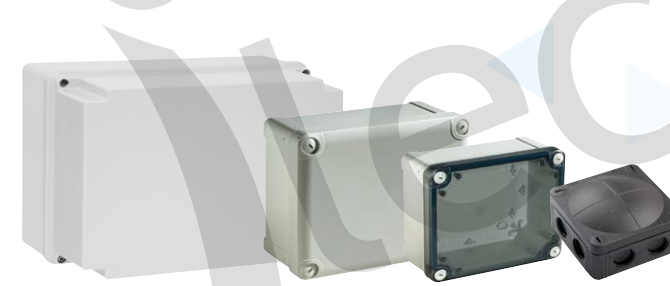

**Modular Enclosures**

**Mild Steel Distribution Enclosures**

Schneider NSYS3DM	20-21
-------------------	-------

**ABS Distribution Enclosures**

Pablo Modular	100-101
---------------	---------



**Aluminium Enclosures**

**Die-Cast Aluminium Enclosures**

Connect 5190 Painted Enclosures	103
ELEG & GAIN Unpainted Enclosures	103

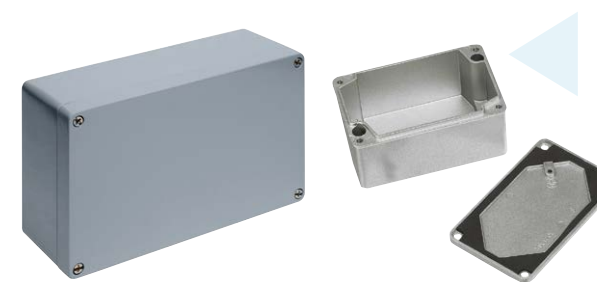

The Spacial NSYS3D has a one piece folded and welded body, finished with textured polyester powder paint to RAL7035. IP66 for single door enclosures and IP55 for double door enclosures to IEC60529. NEMA Type 4, 4X for single door enclosures and NEMA 12, 12K, 13 for double door enclosures to NEMA 250 standard.

**IP66 RAL7035**  
Spacial NSYS3D Mild Steel Wall Mounted Enclosures

REF NO	Dimensions (mm) H x W x D	Weight kg	Gland Plate	PRICE
NSYS3D6830P	600 x 800 x 300	33	D (x2)	187.24
NSYS3D7525P	700 x 500 x 250	19.15	E	139.57
NSYS3D8620P	800 x 600 x 200	26.66	F	144.40
NSYS3D8625P	800 x 600 x 250	21.8	F	172.89
NSYS3D8630P	800 x 600 x 300	29.25	G	190.23
NSYS3D8640P	800 x 600 x 400	36	G	219.28
NSYS3D8825P	800 x 800 x 250	40	D (x2)	193.20
NSYS3D8830P	800 x 800 x 300	42	D (x2)	220.00
NSYS3D81030P	800 x 1000 x 300	52	E (x2)	269.73
NSYS3D10625P	1000 x 600 x 250	40	F	213.55
NSYS3D10630P	1000 x 600 x 300	39.8	G	218.41
NSYS3D10640P	1000 x 600 x 400	42.6	G	243.85
NSYS3D10825P	1000 x 800 x 250	49	D (x2)	231.38
NSYS3D10830P	1000 x 800 x 300	52	D (x2)	244.46
NSYS3D10840P	1000 x 800 x 400	56.3	D (x2)	281.24
NSYS3D101030P	1000 x 1000 x 300	63	E (x2)	301.45
NSYS3D12630P	1200 x 600 x 300	47.25	G	260.88
NSYS3D12640P	1200 x 600 x 400	52	G	260.64
NSYS3D12830P	1200 x 800 x 300	63.5	D (x2)	294.92
NSYS3D12840P	1200 x 800 x 400	68	D (x2)	372.60
NSYS3D121030P	1200 x 1000 x 300	74	E (x2)	372.82

**IP55 RAL7035**  
Spacial NSYS3D Double Door Steel Wall Mounted Enclosures

REF NO	Dimensions (mm) H x W x D	Weight kg	Gland Plate	PRICE
NSYS3D81030DP	800 x 1000 x 300	51.3	E (x2)	289.44
NSYS3D81230DP	800 x 1200 x 300	45	E (x2)	312.61
NSYS3D101030DP	1000 x 1000 x 300	64	E (x2)	329.17
NSYS3D101230DP	1000 x 1200 x 300	75	E (x2)	399.32
NSYS3D101240DP	1000 x 1200 x 400	90.5	E (x2)	565.76
NSYS3D121030DP	1200 x 1000 x 300	81	E (x2)	392.15
NSYS3D121040DP	1200 x 1000 x 400	87	E (x2)	419.41
NSYS3D121230DP	1200 x 1200 x 300	91	E (x2)	413.73
NSYS3D121240DP	1200 x 1200 x 400	112	E (x2)	708.08
NSYS3D141030DP	1400 x 1000 x 300	108	E (x2)	774.45

**NSYS3D Wall Fixing Brackets**

REF NO	Description	PRICE
NSYAEFPFSC	Wall Fixing Brackets (x4)	5.74
NSYAEFPFXSC	Stainless Steel Wall Fixing Brackets (x4)	15.48



**NSYS3D Accessories**

REF NO	Description	PRICE
NSYAE DL1242S3D	Key Lock with 1242 KEY	8.09
NSYAE DL405S3D	Key Lock with 405 KEY	12.11
NSYAE DLS8S3D	8mm Square lock	8.09
NSYAE DLT8S3D	8mm Triangular lock	8.09
NSYAE DLS7S3D	7mm Square lock	8.09
NSYAE DLPADS3D	Lock cover with padlock facility	40.38
NSYINLCRN	Door Switch 1NO NC Contact	36.71
NSYBPA7035	Touch-up Paint - 400ml Aerosol	27.32



**Universal Key**

REF NO	Description	PRICE
2-701-7047BJ	Universal Enclosure Key for 3mm & 5mm DIN Double Bar Locks, Square and Triangular Locks	1.99



NSYS3D3215P

**IP66 RAL7035**  
Spacial NSYS3D Mild Steel Wall Mounted Enclosures

REF NO	Dimensions (mm) H x W x D	Weight kg	Gland Plate	PRICE
NSYS3D3215P	300 x 200 x 150	3.61	A	52.08
NSYS3D32515P	300 x 250 x 150	4.1	A	53.48
NSYS3D3315P	300 x 300 x 150	4.8	B	55.54
NSYS3D3320P	300 x 300 x 200	5.48	C	59.62
NSYS3D3415P	300 x 400 x 150	6	B	60.36
NSYS3D3420P	300 x 400 x 200	6.92	D	64.81
NSYS3D4315P	400 x 300 x 150	6.2	B	61.29
NSYS3D4320P	400 x 300 x 200	6.92	C	67.11
NSYS3D4420P	400 x 400 x 200	8.65	D	75.04
NSYS3D4620P	400 x 600 x 200	13.2	F	98.40
NSYS3D4625P	400 x 600 x 250	14.5	F	103.90
NSYS3D5320P	500 x 300 x 200	8.4	C	86.70
NSYS3D5420P	500 x 400 x 200	10.6	D	91.31
NSYS3D5425P	500 x 400 x 250	11.4	D	102.67
NSYS3D5520P	500 x 500 x 200	13	E	105.55
NSYS3D5525P	500 x 500 x 250	15	E	124.72
NSYS3D6420P	600 x 400 x 200	13.1	D	94.63
NSYS3D6425P	600 x 400 x 250	14.35	D	102.76
NSYS3D6525P	600 x 500 x 250	17	E	113.92
NSYS3D6620P	600 x 600 x 200	18	F	117.78
NSYS3D6625P	600 x 600 x 250	19.74	F	139.22
NSYS3D6630P	600 x 600 x 300	21	G	151.54
NSYS3D6640P	600 x 600 x 400	23	G	175.23



NSYS3D enclosures are supplied complete with mounting plate. Enclosures up to 500mm in height have one lock and enclosures 600mm in height and above have a 3 point locking system.



NSYS3D121030DP

**KEEP BLUNTING DRILL BITS?**

CONTACT OUR ENGINEERING DEPARTMENT TODAY ON 01844 397300 FOR CNC MACHINING OPTIONS

The Spacial NSYS3D has a one piece folded and welded body, finished with textured polyester powder paint to RAL7035.

IP66 for single door enclosures and IP55 for double door enclosures to IEC60529. NEMA Type 4, 4X for single door enclosures and NEMA 12, 12K, 13 for double door enclosures to NEMA 250 standard.



NSYS3D6420T

**IP66 RAL7035**

**Spacial NSYS3D Mild Steel Wall Mounted Enclosures with Glazed Door**

REF NO	Dimensions (mm) H x W x D	Weight kg	Gland Plate	PRICE
NSYS3D32515T	300 x 250 x 150	3.61	A	90.32
NSYS3D3315T	300 x 300 x 150	4.04	B	80.66
NSYS3D3320T	300 x 300 x 200	4.64	C	84.74
NSYS3D3415T	300 x 400 x 150	4.96	B	83.42
NSYS3D3420T	300 x 400 x 200	5.9	D	88.30
NSYS3D4315T	400 x 300 x 150	5	B	83.86
NSYS3D4320T	400 x 300 x 200	5.5	C	87.82
NSYS3D4420T	400 x 400 x 200	6.99	D	93.60
NSYS3D4620T	400 x 600 x 200	10.5	F	114.36
NSYS3D4625T	400 x 600 x 250	11.82	F	121.20
NSYS3D5320T	500 x 300 x 200	7.5	C	99.46
NSYS3D5420T	500 x 400 x 200	8.32	D	103.47
NSYS3D5425T	500 x 400 x 250	9	D	115.03
NSYS3D5520T	500 x 500 x 200	9.9	E	132.65
NSYS3D5525T	500 x 500 x 250	10.8	E	128.83
NSYS3D6420T	600 x 400 x 200	10.67	D	149.12
NSYS3D6425T	600 x 400 x 250	11.5	D	165.07
NSYS3D6525T	600 x 500 x 250	13.4	E	195.78
NSYS3D6620T	600 x 600 x 200	14	F	197.98
NSYS3D6625T	600 x 600 x 250	15.4	F	149.12
NSYS3D6630T	600 x 600 x 300	16.5	G	165.07
NSYS3D6640T	600 x 600 x 400	19.3	G	195.78
NSYS3D6830T	600 x 800 x 300	25	D (x2)	197.98
NSYS3D7525T	700 x 500 x 250	19.3	E	149.50
NSYS3D8620T	800 x 600 x 200	18.6	F	152.08
NSYS3D8625T	800 x 600 x 250	20.1	F	179.28
NSYS3D8630T	800 x 600 x 300	21.3	G	201.82

Mounting plates should be ordered separately for glazed door enclosures  
Window is 4mm thick safety glass - IK08

**IP66 RAL7035**

**Spacial NSYS3D Mild Steel Wall Mounted Enclosures with Glazed Door**

REF NO	Dimensions (mm) H x W x D	Weight kg	Gland Plate	PRICE
NSYS3D8640T	800 x 600 x 400	27.2	G	239.64
NSYS3D8825T	800 x 800 x 250	25.2	D (x2)	195.99
NSYS3D8830T	800 x 800 x 300	31	D (x2)	230.72
NSYS3D10625T	1000 x 600 x 250	28	F	215.95
NSYS3D10630T	1000 x 600 x 300	29	G	227.72
NSYS3D10640T	1000 x 600 x 400	34	G	255.29
NSYS3D10825T	1000 x 800 x 250	34	D (x2)	234.71
NSYS3D10830T	1000 x 800 x 300	37	D (x2)	251.48
NSYS3D10840T	1000 x 800 x 400	41	D (x2)	299.28
NSYS3D101030T	1000 x 1000 x 300	43	E (x2)	307.91
NSYS3D12630T	1200 x 600 x 300	32	G	263.27
NSYS3D12640T	1200 x 600 x 400	37	G	296.56
NSYS3D12830T	1200 x 800 x 300	42	D (x2)	300.99
NSYS3D12840T	1200 x 800 x 400	48	D (x2)	401.92
NSYS3D121030T	1200 x 1000 x 300	47	E (x2)	374.88

**IP55 RAL7035**

**Spacial NSYS3D Double Door Mild Steel Wall Mounted Enclosures with Glazed Door**

REF NO	Dimensions (mm) H x W x D	Weight kg	Gland Plate	PRICE
NSYS3D101030DT	1000 x 1000 x 300	45	E (x2)	343.95
NSYS3D121030DT	1200 x 1000 x 300	52	E (x2)	386.27



NSYS3D5420T WITH NSYPIN54

**RAL7035**

**Internal Door for NSYS3D Enclosures - Mild Steel**

REF NO	Suitable for Enclosure size (mm)		Dimensions of Internal Door (mm)		PRICE
	H	W	H	W	
NSYPIN43	400	x 300	349	x 241	62.44
NSYPIN54	500	x 400	449	x 341	69.33
NSYPIN64	600	x 400	549	x 341	79.04
NSYPIN75	700	x 500	649	x 441	81.66
NSYPIN86	800	x 600	749	x 541	108.66
NSYPIN106	1000	x 600	949	x 541	99.23
NSYPIN108	1000	x 800	949	x 741	116.96
NSYPIN126	1200	x 600	1149	x 541	120.27
NSYPIN128	1200	x 800	1149	x 741	147.92

**Mounting Plates for NSYS3D...T Enclosures - Galvanised Steel**

The galvanised steel NSYMM backplates are the most commonly used which have pre-drilled fixing holes.

REF NO	Dimensions (mm) H x W	Weight kg	Thickness mm	PRICE
NSYMM3025	250 x 200	0.8	2	6.45
NSYMM33	250 x 250	1.4	2	6.63
NSYMM43	350 x 250	1.6	2	6.76
NSYMM44	350 x 350	2.2	2	11.55
NSYMM53	450 x 250	1.8	2	10.31
NSYMM54	450 x 350	2.5	2	14.20
NSYMM55	450 x 450	3.7	2	17.18
NSYMM64	550 x 350	3.1	2	15.04
NSYMM65	550 x 450	4	2	21.63
NSYMM66	550 x 550	5.5	2	24.83
NSYMM75	650 x 450	4.6	2.5	24.83
NSYMM86	750 x 550	9.9	2.5	35.31
NSYMM88	750 x 750	13.6	2.5	42.87
NSYMM106	950 x 550	12.6	2.5	47.81
NSYMM108	950 x 750	16.9	2.5	51.45
NSYMM1010	950 x 950	18.6	2.5	65.30
NSYMM126	1150 x 550	24.9	2.5	48.64
NSYMM128	1150 x 750	17.8	2.5	64.05
NSYMM1210	1150 x 950	21.7	2.5	85.31

NSYMM\*\*\*

**Adjustable Depth Supports**

Depth adjustable supports can be used to vary the position of an internal door or a mounting plate.

REF NO	Description	PRICE
NSYSDCR200	Adjustable Depth Supports 200mm Deep	30.53
NSYSDCR250	Adjustable Depth Supports 250mm Deep	32.35
NSYSDCR300	Adjustable Depth Supports 300mm Deep	33.60
NSYSDCR400	Adjustable Depth Supports 400mm Deep	64.16



**NSYS3D Wall Fixing Brackets**

REF NO	Description	PRICE
NSYAEFPFSC	Wall Fixing Brackets (x4)	5.74
NSYAEFPFXSC	Stainless Steel Wall Fixing Brackets (x4)	15.48



NSYAEFPFSC

**NSYS3D Accessories**

REF NO	Description	PRICE
NSYAE DL1242S3D	Key Lock with 1242 KEY	8.09
NSYAE DL405S3D	Key Lock with 405 KEY	12.11
NSYAE DLS8S3D	8mm Square lock	8.09
NSYAE DLT8S3D	8mm Triangular lock	8.09
NSYAE DLS7S3D	7mm Square lock	8.09
NSYAE DLPADS3D	Lock cover with padlock facility	40.38
NSYINLCRN	Door Switch 1NO NC Contact	36.71
NSYBPA7035	Touch-up Paint - 400ml Aerosol	27.32



NSYAE DL1242S3D

NSYINLCRN



NSYAE DLPADS3D



**NEW!**

**Universal Key**

REF NO	Description	PRICE
2-701-7047BJ	Universal Enclosure Key for 3mm & 5mm DIN Double Bar Locks, Square and Triangular Locks	1.99

Steel enclosures constructed from a continuous length of sheet steel, double folded at the front with the rear welded to the frame. Protected inside and out with polyester epoxy resin textured paint in RAL7035. Doors are reversible.



## IP66 RAL7035

### NSYCRN Wall Mounting Steel Enclosure

REF NO	Dimensions (mm) H x W x D	Weight kg	Cable Entry	PRICE
NSYCRN22150	200 x 200 x 150	3	O	102.84
NSYCRN23150	200 x 300 x 150	3.9	B	111.47
NSYCRN252150	250 x 200 x 150	3.2	O	53.05
NSYCRN325150	300 x 250 x 150	4.2	A	43.00
NSYCRN325200	300 x 250 x 200	4.9	A	46.18
NSYCRN34200	300 x 400 x 200	6.4	C	58.32
NSYCRN345150	300 x 450 x 150	6	B	116.84
NSYCRN33150	300 x 300 x 150	5	B	48.53
NSYCRN33200	300 x 300 x 200	6	B	53.19
NSYCRN43150	400 x 300 x 150	6	B	52.40
NSYCRN43200	400 x 300 x 200	6.8	B	58.96
NSYCRN44200	400 x 400 x 200	8	C	63.32
NSYCRN46250	400 x 600 x 250	10	D	88.04
NSYCRN46300	400 x 600 x 300	11.2	D	114.95
NSYCRN54150	500 x 400 x 150	8.7	B	67.35
NSYCRN54200	500 x 400 x 200	9.8	C	77.15
NSYCRN54250	500 x 400 x 250	11	C	88.95
NSYCRN55250	500 x 500 x 250	12.8	D	104.68
NSYCRN64150	600 x 400 x 150	9.3	B	73.33
NSYCRN64200	600 x 400 x 200	10.8	C	79.82

## IP66 RAL7035

### NSYCRN Wall Mounting Steel Enclosure

REF NO	Dimensions (mm) H x W x D	Weight kg	Cable Entry	PRICE
NSYCRN64250	600 x 400 x 250	12.3	C	86.17
NSYCRN65150	600 x 500 x 150	11.3	B	80.29
NSYCRN65200	600 x 500 x 200	14.3	D	93.69
NSYCRN65250	600 x 500 x 250	16.3	D	96.77
NSYCRN66200	600 x 600 x 200	15	D	95.76
NSYCRN66250	600 x 600 x 250	18.2	D	113.84
NSYCRN66300	600 x 600 x 300	19.8	D	144.68
NSYCRN68300	600 x 800 x 300	26	E	139.12
NSYCRN75200	700 x 500 x 200	17.3	D	104.50
NSYCRN75250	700 x 500 x 250	19.3	D	112.35
NSYCRN86200	800 x 600 x 200	21.8	D	112.86
NSYCRN86250	800 x 600 x 250	24.8	D	133.75
NSYCRN86300	800 x 600 x 300	26.3	D	150.71
NSYCRNG86400	800 x 600 x 400	31.3	D	252.32
NSYCRN88200	800 x 800 x 200	29.5	D	177.17
NSYCRN88300	800 x 800 x 300	32.5	E	183.64
NSYCRN106250	1000 x 600 x 250	28.4	E	165.95
NSYCRN106300	1000 x 600 x 300	30.6	D	189.43
NSYCRNG106400*	1000 x 600 x 400	34	D	280.25
NSYCRN108250	1000 x 800 x 250	34.5	D	179.91
NSYCRN108300	1000 x 800 x 300	37.4	E	202.97
NSYCRNG108400*	1000 x 800 x 400	43	E	295.67
NSYCRNG126300*	1200 x 600 x 300	34.5	D	311.78
NSYCRNG126400*	1200 x 600 x 400	37.4	D	335.88
NSYCRNG128300*	1200 x 800 x 300	44.8	E	290.95
NSYCRNG128400*	1200 x 800 x 400	49.5	E	360.78



NSYCRN86300

## IP55 RAL7035

### NSYCRN Double Door Steel Wall Mounted Enclosures

REF NO	Dimensions (mm) H x W x D	Weight kg	Gland Plate	PRICE
NSYCRNG810300D*	800 x 1000 x 300	37	E	302.63
NSYCRNG812300D*	800 x 1200 x 300	42	E	346.40
NSYCRNG1010300D*	1000 x 1000 x 300	46.7	E	349.88
NSYCRNG1012300D*	1000 x 1200 x 300	41	E	364.47
NSYCRNG1012400D	1000 x 1200 x 400	50	E	708.84
NSYCRNG1210300D	1200 x 1000 x 300	53.4	E	378.86
NSYCRNG1210400D*	1200 x 1000 x 400	62	E	487.80
NSYCRNG1212300D*	1200 x 1200 x 300	70	E	448.34
NSYCRNG1212400D	1200 x 1200 x 400	91.6	E	844.03



NSYCRNG1212300D

### NSYCRN Wall Fixing Brackets

REF NO	Description	PRICE
NSYPFCR	Wall Fixing Brackets (x4)	5.74
NSYAEFPFSC	Wall Fixing Brackets for NSYCRNG (x4)	5.80



### Mounting Plates for NSYCRN Enclosures Galvanised Steel

The galvanised steel NSYMM backplates are the most commonly used which have pre-drilled fixing holes.

REF NO	Dimensions (mm) H x W	Weight kg	Thickness mm	PRICE
NSYMM22	150 x 150	0.25	2	5.57
NSYMM2520	200 x 150	0.4	2	6.49
NSYMM3025	250 x 200	0.8	2	6.45
NSYMM33	250 x 250	1.4	2	6.63
NSYMM43	350 x 250	1.6	2	6.76
NSYMM44	350 x 350	2.2	2	11.55
NSYMM54	450 x 350	2.5	2	14.20
NSYMM55	450 x 450	3.7	2	17.18
NSYMM64	550 x 350	3.1	2	15.04
NSYMM65	550 x 450	4	2	21.63
NSYMM66	550 x 550	5.5	2	24.83
NSYMM75	650 x 450	4.6	2.5	24.83
NSYMM86	750 x 550	9.9	2.5	35.31
NSYMM88	750 x 750	13.6	2.5	42.87
NSYMM106	950 x 550	12.6	2.5	47.81
NSYMM108	950 x 750	16.9	2.5	51.45
NSYMM1010	950 x 950	18.6	2.5	65.30
NSYMM126	1150 x 550	24.9	2.5	48.64
NSYMM128	1150 x 750	17.8	2.5	64.05
NSYMM1210	1150 x 950	21.7	2.5	85.31
NSYMM1212	1150 x 1150	24.9	2.5	104.38



Plates can be used in both orientations. For example an NSYMM64 can be used in an NSYCRN46250

### NSYCRN Accessories

REF NO	Description	PRICE
NSYCL405CRN	Key Lock with 405 Key	8.32
NSYTL405SML	Key Lock with 405 Key for NSYCRNG	44.44
NSYCDB3	Standard Replacement Lock	2.80
NSYTC8CRN	8mm Square lock	16.14
NSYTT8CRN	8mm Triangular lock	8.09
NSYTC7CRN	7mm Square lock	11.53
NSYINLCRN	Door Switch 1NO NC Contact	36.71
NSYBPA7035	Touch-up Paint - 400ml Aerosol	27.32

NSYCRN enclosures are supplied without mounting plates  
Enclosures up to 400mm in height have one lock and enclosures over 500mm height have two locks  
Enclosures marked with \* have a three point locking system.

The majority of the NSY Accessories can be used for both the NSYCRN & NSYS3D Enclosures. The only exception are the locks and wall fixing brackets which are shown with the enclosures.

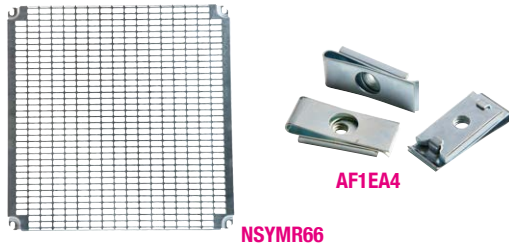

NSYMR66

**Telequick Mounting Plates for NSYCRN & NSYS3D Enclosures**

Telequick Mounting Plates are ideal for the rapid mounting of components using the AF1 clips

REF NO	Dimensions (mm)			Weight kg	PRICE
	H	x	W		
NSYMR32	255	x	154	0.3	5.49
NSYMR3025	253	x	228	0.46	8.25
NSYMR33	255	x	250	0.51	9.91
NSYMR43	349	x	250	0.72	11.29
NSYMR44	345	x	350	0.98	14.33
NSYMR46	345	x	550	1.52	18.82
NSYMR54	450	x	350	1.02	15.89
NSYMR55	450	x	450	1.4	21.36
NSYMR64	555	x	350	1.36	16.26
NSYMR65	555	x	450	1.68	24.17
NSYMR66	555	x	550	2.02	25.59
NSYMR75	645	x	450	2	26.70
NSYMR86	750	x	550	2.8	39.23
NSYMR88	750	x	750	3.6	41.23
NSYMR106	945	x	550	3.52	42.61
NSYMR108	945	x	750	5.2	44.66
NSYMR1010	945	x	950	6.3	71.42
NSYMR1012	950	x	1150	8	97.87
NSYMR128	1145	x	750	6	69.48
NSYMR1410	1345	x	950	8.6	69.48

AF1EA4	M4 Fixing Nut for Telequick Chassis Pk/100	38.24
AF1EA5	M5 Fixing Nut for Telequick Chassis Pk/100	36.95
AF1EA6	M6 Fixing Nut for Telequick Chassis Pk/100	36.95



NSYSPS\*\*\*SD

**RAL7035**

**Internal Door for NSYCRN & NSYS3D Enclosures**

REF NO	Suitable for Enclosure size (mm)			Dimensions of Internal Door (mm)			PRICE
	H	x	W	H	x	W	
NSYPIN43	400	x	300	349	x	241	59.47
NSYPIN54	500	x	400	449	x	341	66.03
NSYPIN64	600	x	400	549	x	341	69.56
NSYPIN75	700	x	500	649	x	441	77.77
NSYPIN86	800	x	600	749	x	541	103.74
NSYPIN106	1000	x	600	949	x	541	94.50
NSYPIN108	1000	x	800	949	x	741	111.39
NSYPIN126	1200	x	600	1149	x	541	114.54
NSYPIN128	1200	x	800	1149	x	741	140.88



**Adjustable Depth Supports**

Depth adjustable supports can be used to vary the position of an internal door or a mounting plate.

REF NO	Description	PRICE
NSYSDCR200	Adjustable Depth Supports 200mm Deep	29.08
NSYSDCR250	Adjustable Depth Supports 250mm Deep	30.81
NSYSDCR300	Adjustable Depth Supports 300mm Deep	32.00
NSYSDCR400	Adjustable Depth Supports 400mm Deep	61.10

**Plinths for NSYCRN & NSYS3D Enclosures - 100mm High**

REF	Description	PRICE
NSYSPPF6100	Front/Rear Plinths - 600mm Wide	35.82
NSYSPPF8100	Front/Rear Plinths - 800mm Wide	37.71
NSYSPPF10100	Front/Rear Plinths - 1000mm Wide	46.78
NSYSPPF12100	Front/Rear Plinths - 1200mm Wide	58.54
NSYSPPF12100SD	Pair of Side Plinths - 300mm Deep	12.79
NSYSPPF12100SD	Pair of Side Plinths - 400mm Deep	10.95
NSYAPFWM	Plinth Fixing Kit	5.46

Spare gland plates are available for all Schneider NSY enclosures. Please ask for details or see our website.

**RAL7035**

**Canopies for NSYCRN & NSYS3D Enclosures**

The slightly sloped canopy acts as an outdoor protection for the enclosure.



REF NO	Dimensions (mm)				Weight kg	PRICE	
	W	x	D	x			H
NSYTJ2015	200	x	150	x	36	0.8	27.84
NSYTJ2515	250	x	150	x	36	0.9	30.81
NSYTJ2520	250	x	200	x	36	1.0	36.50
NSYTJ3015	300	x	150	x	36	1.0	31.45
NSYTJ3020	300	x	200	x	36	1.3	38.67
NSYTJ4015	400	x	150	x	36	1.2	31.68
NSYTJ4020	400	x	200	x	36	1.7	39.45
NSYTJ4025	400	x	250	x	42	2.0	41.07
NSYTJ5015	500	x	150	x	36	1.6	33.14
NSYTJ5020	500	x	200	x	36	2.1	39.91
NSYTJ5025	500	x	250	x	42	2.4	42.08
NSYTJ6020	600	x	200	x	36	2.3	41.70
NSYTJ6025	600	x	250	x	42	2.8	44.63
NSYTJ6030	600	x	300	x	42	3.2	46.61
NSYTJ6040	600	x	400	x	42	4.1	57.56
NSYTJ8020	800	x	200	x	42	3	44.08
NSYTJ8025	800	x	250	x	42	3.6	48.77
NSYTJ8030	800	x	300	x	42	4.2	52.77
NSYTJ8040	800	x	400	x	42	5.3	76.34
NSYTJ10030	1000	x	300	x	42	5	84.64
NSYTJ10040	1000	x	400	x	42	6.4	128.98
NSYTJ12030	1200	x	300	x	42	6	87.86
NSYTJ12040	1200	x	400	x	42	7.6	98.65

**Self Adhesive Document Pockets**

REF NO	Description	PRICE
NSYDPA3	Document Pocket for A3 Documents	17.27
NSYDPA4	22mm Deep Document Pocket for A4 Documents	7.38
NSYDPA44	40mm Deep Document Pocket for A4 Documents	7.14
NSYDPA5	Document Pocket for A5 Documents	6.02

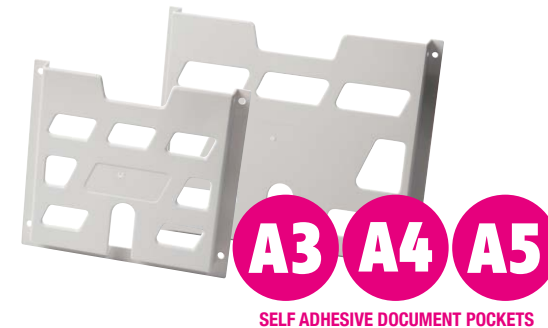

**A3 A4 A5**  
SELF ADHESIVE DOCUMENT POCKETS



**Louvre Plates - IP20**

REF NO	Dimensions (mm)			PRICE
	H	x	W	
NSYCAG110X46M	144	x	62	3.78
NSYCAG180X62M	208	x	90	6.51
NSYCAG216X62M	244	x	90	7.97
NSYCAG317X91M	345	x	118	10.49
NSYCAG317X120M	345	x	148	10.91
NSYCAG417X120M	445	x	148	11.49

**Universal Enclosure Key**

This handy Universal Key has been designed for use on locking systems for electrical cabinets, gas and water cupboards and technical installations on-site and in buildings.

This multi-way key is manufactured from high quality die-cast zinc alloy, making it a tough durable tool for all engineers.

The key will operate 6mm, 7mm and 8mm square locks, 7mm and 8mm triangular locks and 3mm and 5mm DIN double bar locks.

The centre hub also has a 1/4" (6.3mm) hex drive for use with all standard screwdriver, socket set drives and drill bits to access tight spaces with maximum torque.



The Spacial NSYS3DM has a one piece folded and welded body, finished with textured polyester powder paint to RAL7035.

Available in 8 sizes with 10 Chassis options.

It is rated to IP66 and is specifically designed to accept the chassis for modular equipment and therefore only 150mm deep.

GLAZED WINDOW

NEW!

**IP66 RAL7035**  
Spacial NSYS3DM Mild Steel Wall Mounted Enclosures with Glazed Door

REF NO	Dimensions (mm)			Weight kg	PRICE
	H	x W	x D		
NSYS3DM4315T	400	x 300	x 150	7.84	97.89
NSYS3DM5415T	500	x 400	x 150	8.47	123.87
NSYS3DM6415T	600	x 400	x 150	9.92	119.99
NSYS3DM6615T	600	x 600	x 150	13.18	138.48
NSYS3DM7515T	700	x 500	x 150	12.7	135.74
NSYS3DM8615T	800	x 600	x 150	19.9	164.49
NSYS3DM10615T	1000	x 600	x 150	33.5	197.70
NSYS3DM10815T	1000	x 800	x 150	41	217.91

Only 150mm Deep

Top Gland Plate

NSYS3DM Enclosures for Modular Chassis

Bottom Gland Plate

Glazed Door as Standard



NSYDLM24

Modular Chassis for NSYS3D and NSYCRN Enclosures

These modular chassis fit directly onto the standard mounting plate studs

REF NO	Suitable for Enclosure (mm)		Number of Modules	PRICE
	H	x W		
NSYDLM24	400	x 300	2 Rows of 12 = 24	82.91
NSYDLM48	500	x 400	3 Rows of 16 = 48	101.93
NSYDLM48P	600	x 400	3 Rows of 16 = 48	118.21
NSYDLM84P	600	x 600	3 Rows of 28 = 84	133.99
NSYDLM66	700	x 500	3 Rows of 22 = 66	143.81
NSYDLM84	800	x 600	3 Rows of 28 = 84	166.46
NSYDLM88	700	x 500	4 Rows of 22 = 88	154.21
NSYDLM112	800	x 600	4 Rows of 28 = 112	179.15
NSYDLM168	1000	x 600	6 Rows of 28 = 168	226.38
NSYDLM240	1000	x 800	6 Rows of 40 = 240	242.09

Chassis Layout Diagrams

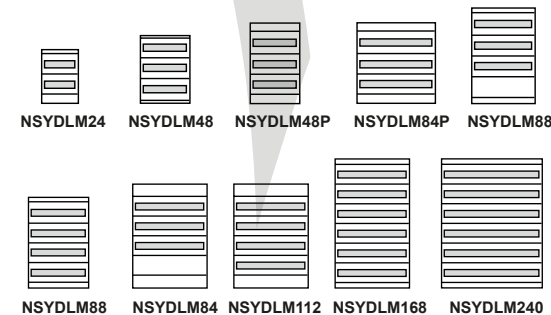

Full range of modular products available in our Control Gear and Distribution sections



Modular Chassis for NSYS3D and NSYCRN Enclosures

REF NO	Description	PRICE
NSYCTL300DLM	Plain Front Panel for DLM24	8.07
NSYCTL400DLM	Plain Front Panel for DLM48/DLM48P	12.38
NSYCTL500DLM	Plain Front Panel for DLM66	14.72
NSYCTL600DLM	Plain Front Panel for DLM84, DLM84P, DLM112 and DLM168	16.12
NSYCTL800DLM	Plain Front Panel for DLM240	21.38
NSYPMP300DLM	Mounting plate for DLM24	12.66
NSYPMP400DLM	Mounting Plate for DLM48/DLM48P	14.00
NSYPMP500DLM	Mounting Plate for DLM66	16.76
NSYPMP600DLM	Mounting Plate for DLM84, DLM84P, DLM112 and DLM168	15.97
NSYPMP800DLM	Mounting Plate for DLM240	23.65



Modular blanks are also available  
For wall fixing brackets and keylocks, please see page 13

Layout Dimensions

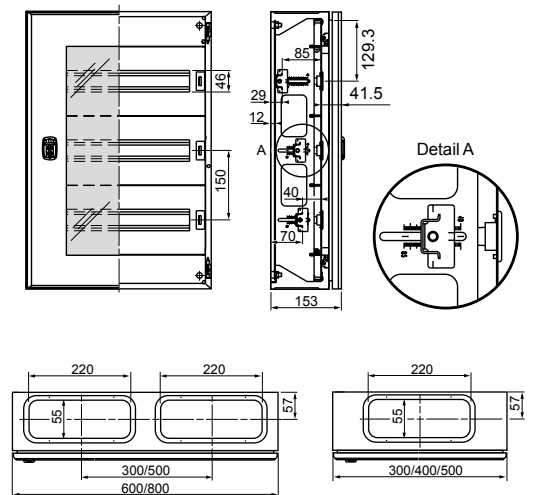

The Eldon MAS range have a single door, rated to IP66, NEMA 4, 12, 13 IK10.

The Eldon MAD range of enclosures have double doors and are rated to IP55/NEMA 12 IK10 and have a three point locking system.

Finished with textured polyester powder paint RAL7035 and come complete with mounting plate.



MAS0806026R5

MAS0504021R5

**IP66 RAL7035**  
Eldon Mild Steel Wall Mounted Enclosures  
Single Door - IP66

REF NO	Dimensions (mm)				Weight kg	PRICE
	H	x	W	x		
MAS0202015R5	200	x	200	x	155	2.7 47.16
MAS0252015R5	250	x	200	x	155	3.1 49.64
MAS0252515R5	250	x	250	x	155	4.0 52.25
MAS0302515R5	300	x	250	x	155	4.2 55.00
MAS0302521R5	300	x	250	x	210	5.3 61.72
MAS0303015R5	300	x	300	x	155	5.2 60.73
MAS0303021R5	300	x	300	x	210	5.5 68.45
MAS0352515R5	350	x	250	x	155	5.3 61.34
MAS0403015R5	400	x	300	x	155	6.5 70.87
MAS0403021R5	400	x	300	x	210	7.0 74.60
MAS0404021R5	400	x	400	x	210	8.6 77.22
MAS0405021R5	400	x	500	x	210	10.5 89.46
MAS0406021R5	400	x	600	x	210	12.2 101.71
MAS0503021R5	500	x	300	x	210	8.6 84.61
MAS0504015R5	500	x	400	x	155	8.5 83.77
MAS0504021R5	500	x	400	x	210	10.4 88.18
MAS0504026R5	500	x	400	x	260	11.2 106.75
MAS0504030R5	500	x	400	x	300	12.1 125.32
MAS0505021R5	500	x	500	x	210	12.56 107.91
MAS0505030R5	500	x	500	x	300	14.5 139.24
MAS0604015R5	600	x	400	x	155	11.5 87.25
MAS0604021R5	600	x	400	x	210	12.2 90.89

Enclosures up to 500 x 500mm have a single lock.  
Enclosures 600 x 400mm to 800 x 800mm have 2 locks.  
Enclosures 1000mm and 1200mm high have a 3 point locking system.

**IP66 RAL7035**

Eldon Mild Steel Wall Mounted Enclosures  
Single Door - IP66

REF NO	Dimensions (mm)				Weight kg	PRICE
	H	x	W	x		
MAS0604026R5	600	x	400	x	260	13.6 117.43
MAS0604030R5	600	x	400	x	300	14.5 143.96
MAS0605015R5	600	x	500	x	155	14.2 101.92
MAS0605021R5	600	x	500	x	210	15.4 105.92
MAS0605026R5	600	x	500	x	260	16.6 131.78
MAS0605030R5	600	x	500	x	300	17.5 157.63
MAS0606021R5	600	x	600	x	210	21.0 120.94
MAS0606030R5	600	x	600	x	300	24.0 171.30
MAS0606040R5	600	x	600	x	400	27.0 189.33
MAS0608030R5	600	x	800	x	300	31.0 212.96
MAS0705021R5	700	x	500	x	210	21.0 147.91
MAS0705026R5	700	x	500	x	260	23.2 154.07
MAS0804030R5	800	x	400	x	300	24.0 175.92
MAS0806021R5	800	x	600	x	210	28.0 148.37
MAS0806026R5	800	x	600	x	260	29.8 185.60
MAS0806030R5	800	x	600	x	300	31.0 202.56
MAS0806040R5	800	x	600	x	400	34.0 223.60
MAS0808021R5	800	x	800	x	210	25.0 195.58
MAS0808030R5	800	x	800	x	300	39.0 229.33
MAS0808040R5	800	x	800	x	400	43.0 277.27
MAS1006026R5	1000	x	600	x	260	38.0 209.13
MAS1006030R5	1000	x	600	x	300	39.0 219.59
MAS1008026R5	1000	x	800	x	260	44.0 239.08
MAS1008030R5	1000	x	800	x	300	47.0 249.04
MAS1008040R5	1000	x	800	x	400	51.0 326.99
MAS1206030R5	1200	x	600	x	300	52.0 253.46
MAS1208030R5	1200	x	800	x	300	60.0 290.57
MAS1208040R5	1200	x	800	x	400	66.0 383.77



MAD0608030R5

**IP55 RAL7035**

Eldon Mild Steel Wall Mounted Enclosures  
Double Door - IP55

REF NO	Dimensions (mm)				Weight kg	PRICE
	H	x	W	x		
MAD0608030R5	600	x	800	x	300	31.0 247.57
MAD0801230R5	800	x	1200	x	300	48.0 309.46
MAD1001030R5	1000	x	1000	x	300	63.0 325.75
MAD1201030R5	1200	x	1000	x	300	74.0 385.19
MAD1201230R5	1200	x	1200	x	300	86.0 462.23
MAD1201240R5	1200	x	1200	x	400	92.0 508.10
MAD1401030R5	1400	x	1000	x	300	84.0 489.44

**RAL7035**

Canopies for MAS / MAD Enclosures

The slightly sloped canopy acts as an outdoor protection for the enclosure. Manufactured from 1.5mm mild steel.



ARF\*\*\*\*R5

REF NO	Dimensions (mm)		PRICE	
	W	x		D
ARF02515R5	250	x	155	49.74
ARF02521R5	250	x	210	55.26
ARF03015R5	300	x	155	52.91
ARF03021R5	300	x	210	58.79
ARF04015R5	400	x	155	60.13
ARF04021R5	400	x	210	66.81
ARF04026R5	400	x	260	72.63
ARF04030R5	400	x	300	76.87
ARF05015R5	500	x	155	68.09
ARF05021R5	500	x	210	74.03
ARF05026R5	500	x	260	79.60
ARF05030R5	500	x	300	84.61
ARF06021R5	600	x	210	84.52
ARF06026R5	600	x	260	92.97
ARF06030R5	600	x	300	99.23
ARF06040R5	600	x	400	104.76
ARF08021R5	800	x	210	100.52
ARF08026R5	800	x	260	106.19
ARF08030R5	800	x	300	113.76
ARF08040R5	800	x	400	123.27
ARF10030R5	1000	x	300	131.44
ARF12030R5	1200	x	300	139.81
ARF12040R5	1200	x	400	154.13

**NEW!**

**DW02 Door Wheel**

The door wheel ensures that the enclosure door can always be easily closed, guaranteeing the enclosures ingress protection when under excessive loads.



Eldon Enclosure Accessories

REF NO	Description	PRICE
AW41	Wall Mounting Lugs	6.84
AWS41-304	Wall Mounting Lugs - 304 Stainless Steel	35.51
ALT560	Plastic Handle	14.95
ALT561	Chrome Plated T Handle	35.27
ALT562	Wing Knob 333 Key-lock	34.67
ALT563	Plastic Handle Ronis 5333 Keylock	22.44
PLC01	Padlock Cover - 304 Stainless Steel	37.94
DW02	Door Wheel - Pack of 2	12.98
ADO202	Door Stop to secure door in open position at 90° or 110° - Zinc Plated	8.93
ADO202S	Door Stop to secure door in open position at 90° or 110° - Stainless Steel	35.72
ADSW01	Multimount Door Switch	32.08
DRA04	A4 Drawing Pocket	10.42
BFP7035	Touch-up Paint RAL7035 - 400ml	22.53



Enclosures

**RAL7035**

**Internal Door for MAS Enclosures**

REF NO	Suitable for enclosure size		PRICE
	H	W	
ADI04030R5	400	300	57.14
ADI04040R5	400	400	63.28
ADI05030R5	500	300	60.70
ADI05040R5	500	400	65.74
ADI06040R5	600	400	73.14
ADI06050R5	600	500	79.01
ADI06060R5	600	600	83.03
ADI07050R5	700	500	83.70
ADI08060R5	800	600	96.80
ADI08080R5	800	800	115.40
ADI10060R5	1000	600	113.94
ADI10080R5	1000	800	131.57
ADI12060R5	1200	600	134.79
ADI12080R5	1200	800	155.54



**RAL7035**

**ADT Transparent Door for MAS Enclosures**

REF NO	Suitable for enclosure size		PRICE
	H	W	
ADT03025R5	300	250	37.28
ADT03030R5	300	300	43.99
ADT04030R5	400	300	49.21
ADT04040R5	400	400	55.17
ADT05030R5	500	300	57.72
ADT05040R5	500	400	65.46
ADT06040R5	600	400	73.37
ADT06050R5	600	500	84.32
ADT06060R5	600	600	101.81
ADT07050R5	700	500	104.98
ADT08060R5	800	600	125.98
ADT10060R5	1000	600	157.78
ADT10080R5	1000	800	201.09
ADT12060R5	1200	600	199.62
ADT12080R5	1200	800	226.35



**Plinths for MAS / MAD Enclosures - 100mm High**

REF NO	Description	PRICE
<b>Front/Rear Set</b>		
P1040	For enclosures 400mm wide	52.05
P1060	For enclosures 600mm wide	57.80
P1080	For enclosures 800mm wide	63.78
P1100	For enclosures 1000mm wide	70.51
P1120	For enclosures 1200mm wide	77.65
<b>Pair of Sides</b>		
PA1026	For enclosures 260mm deep	13.77
PA1030	For enclosures 300mm deep	15.07
PA1040	For enclosures 400mm deep	18.22



**iLECSYS In-House Engineering**

Enclosures machined to your specifications.  
Please call for details: **01844 397300**

**IP66/55 RAL7035**

**Eldon MPG Consoles**

Single door enclosures are IP66; NEMA 4, 12 & 13. Double door enclosures are IP55; NEMA 12. The doors are reversible on single door consoles and have a reinforcing drilled profile fixed to the inside which can be used to mount equipment. A mounting plate is included as standard.

They come complete with a standard 3mm DIN lock. Alternative inserts are available as is a locking handle with various inserts.

The bottom section of the enclosure is 400mm deep.

The top panel is held open by a self-engage, self-release mechanical stay.

REF NO	Description	No. of Doors	PRICE
MPG06R5	Console 985mm High x 600mm Wide	1	453.41
MPG08R5	Console 985mm High x 800mm Wide	1	552.37
MPG10R5	Console 985mm High x 1000mm Wide	1	631.50
MPG12R5	Console 985mm High x 1200mm Wide	2	721.27
MPG16R5	Console 985mm High x 1600mm Wide	2	812.14



*These Eldon consoles are also available in 304 & 316L Stainless Steel - MPGS\*\**

*The Eldon MPG range of consoles are an effective one-piece enclosure. The smaller widths of up to 1000mm wide have a single door whereas the 1200mm and 1600mm wide have double doors.*

**Front / Rear Plinth Sections for MPG Console Enclosures**

The Eldon plinths are supplied in two parts and need to be ordered separately. The front/rear sections comprise four corner pieces with removable covers. They are available in 100mm or 200mm heights in dark grey to RAL7022. Fixings are supplied with the front/rear plinth sections

REF NO	Description	PRICE
PF1040	100mm High x 400mm Wide	33.16
PF1060	100mm High x 600mm Wide	36.02
PF1080	100mm High x 800mm Wide	37.20
PF1100	100mm High x 1000mm Wide	48.34
PF1120	100mm High x 1200mm Wide	49.38
PF2040	200mm High x 400mm Wide	54.93
PF2060	200mm High x 600mm Wide	58.16
PF2080	200mm High x 800mm Wide	71.50
PF2100	200mm High x 1000mm Wide	92.05
PF2120	200mm High x 1200mm Wide	99.85

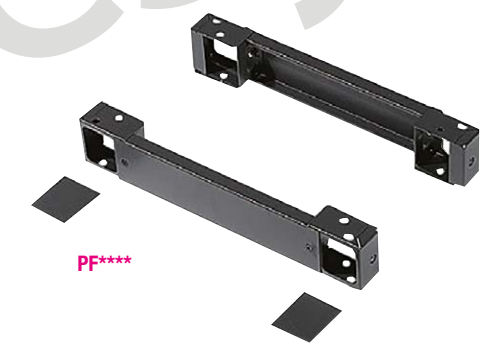

**Side Plinth Sections for MPG Console Enclosures**

REF NO	Description	PRICE
PST1040	100mm High x 400mm Deep	20.27
PST2040	200mm High x 400mm Deep	28.26



The NSYSBM mild steel terminal box range may also be readily adapted for housing isolators, DOL starters and other control equipment.

Rated at IP66, it is finished in textured epoxy paint RAL7035 and an extension frame is also available to provide an additional 80mm to the depth.



**IP66 RAL7035**  
Spacial NSYSBM - Mild Steel RAL7035 Terminal Box 120mm Deep

REF NO	Dimensions (mm)			Internal Depth	PRICE
	H	W	D		
NSYSBM151512	150	150	120	103.5mm	28.87
NSYSBM152012	150	200	120	103.5mm	29.22
NSYSBM153012	150	300	120	103.5mm	31.66
NSYSBM154012	150	400	120	103.5mm	38.42
NSYSBM202012	200	200	120	103.5mm	30.66
NSYSBM203012	200	300	120	103.5mm	32.34
NSYSBM204012	200	400	120	103.5mm	34.67
NSYSBM205012	200	500	120	103.5mm	63.76
NSYSBM206012	200	600	120	103.5mm	65.51
NSYSBM208012	200	800	120	103.5mm	79.55
NSYSBM303012	300	300	120	103.5mm	35.57
NSYSBM304012	300	400	120	103.5mm	37.81
NSYSBM305012	300	500	120	103.5mm	59.29
NSYSBM306012	300	600	120	103.5mm	71.65
NSYSBM308012	300	800	120	103.5mm	90.67
NSYSBM404012	400	400	120	103.5mm	51.02
NSYSBM405012	400	500	120	103.5mm	73.15
NSYSBM406012	400	600	120	103.5mm	82.77
NSYSBM408012	400	800	120	103.5mm	92.93

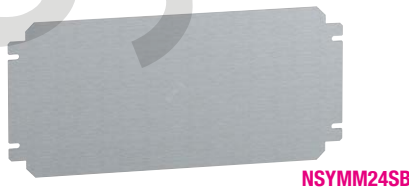

**Mounting Plates for NSYSBM Terminal Boxes**

Mounting plates are available as listed although there are mounting rails as standard incorporated within the enclosure.

REF NO	For Enclosure Size (mm)		Actual Plate Size (mm)		PRICE
	H	W	H	W	
NSYMM11SB	150	150	125	135	3.56
NSYMM12SB	150	200	125	185	4.18
NSYMM13SB	150	300	125	285	4.68
NSYMM14SB	150	400	125	385	5.89
NSYMM22SB	200	200	175	185	4.91
NSYMM23SB	200	300	175	285	5.82
NSYMM24SB	200	400	175	385	7.25
NSYMM25SB	200	500	175	485	9.16
NSYMM26SB	200	600	175	585	10.98
NSYMM28SB	200	800	175	785	17.13
NSYMM33SB	300	300	275	285	8.02
NSYMM34SB	300	400	275	385	10.10
NSYMM35SB	300	500	275	485	12.97
NSYMM36SB	300	600	275	585	15.83
NSYMM38SB	300	800	275	785	21.38
NSYMM44SB	400	400	375	385	19.97
NSYMM45SB	400	500	375	485	24.27
NSYMM46SB	400	600	375	585	27.30
NSYMM48SB	400	800	375	785	30.06

**IP66 RAL7035**  
Spacial NSYSBM - Mild Steel RAL7035 Terminal Box 80mm Deep

REF NO	Dimensions (mm)			Internal Depth	PRICE
	H	W	D		
NSYSBM15158	150	150	80	63.5mm	26.83
NSYSBM15208	150	200	80	63.5mm	27.66
NSYSBM15308	150	300	80	63.5mm	31.43
NSYSBM15408	150	400	80	63.5mm	39.12
NSYSBM20208	200	200	80	63.5mm	28.67
NSYSBM20308	200	300	80	63.5mm	30.64
NSYSBM20408	200	400	80	63.5mm	33.11
NSYSBM20508	200	500	80	63.5mm	58.35
NSYSBM20608	200	600	80	63.5mm	71.71



**IP66 RAL7035**  
Spacial NSYSBM - Mild Steel RAL7035 Terminal Box 80mm Deep - Hinged Lid

REF NO	Dimensions (mm)			Internal Depth	PRICE
	H	W	D		
NSYSBM15158H	150	150	80	63.5mm	36.31
NSYSBM15208H-Long	150	200	80	63.5mm	37.16
NSYSBM15208H-Short	150	200	80	63.5mm	37.16
NSYSBM15308H-Long	150	300	80	63.5mm	40.91
NSYSBM15308H-Short	150	300	80	63.5mm	40.91
NSYSBM15408H-Long	150	400	80	63.5mm	48.60
NSYSBM15408H-Short	150	400	80	63.5mm	48.60
NSYSBM20208H	200	200	80	63.5mm	38.16
NSYSBM20308H-Long	200	300	80	63.5mm	41.82
NSYSBM20308H-Short	200	300	80	63.5mm	41.82
NSYSBM20408H-Long	200	400	80	63.5mm	42.60
NSYSBM20408H-Short	200	400	80	63.5mm	42.60
NSYSBM20508H-Long	200	500	80	63.5mm	72.60
NSYSBM20608H-Long	200	600	80	63.5mm	85.96

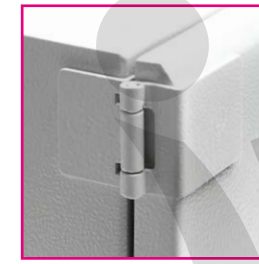

**Spacial NSYSBM Accessories**

REF NO	Description	PRICE
NSYAEPPFSB	Set of 4 Wall Fixing Brackets	8.66
NSYAEHDSB	Pack of 6 Hinges - Machining Required	28.50
NSYSBMA6SB	Replacement Lid Screws Pack of 6	5.65

**Spacial NSYSBM Enclosure Depth Extension Frames**

Adds 80mm to enclosures depth. Maintains IP66. Only 1 can be added.

REF NO	Dimensions (mm)				PRICE	
	W	x	D	x		H
NSYAES228SB	200	x	200	x	80	39.92
NSYAES238SB	200	x	300	x	80	40.99
NSYAES248SB	200	x	400	x	80	43.17
NSYAES258SB	200	x	500	x	80	47.02
NSYAES268SB	200	x	600	x	80	47.42
NSYAES338SB	300	x	300	x	80	43.07
NSYAES348SB	300	x	400	x	80	40.93
NSYAES358SB	300	x	500	x	80	48.14
NSYAES368SB	300	x	600	x	80	42.69

The Spacial NSYSBM are also available with hinges fitted adding versatility to this range of enclosures.

iLECSYS can also customise and populate the enclosures, adding holes, terminals, isolators etc.



**IP66 RAL7035**  
Spacial NSYSBM - Mild Steel RAL7035 Terminal Box 120mm Deep - Hinged Lid

REF NO	Dimensions (mm)			Internal Depth	PRICE
	H	W	D		
NSYSBM151512H	150	150	120	103.5mm	38.36
NSYSBM152012H-Long	150	200	120	103.5mm	38.71
NSYSBM152012H-Short	150	200	120	103.5mm	38.71
NSYSBM153012H-Long	150	300	120	103.5mm	41.16
NSYSBM153012H-Short	150	300	120	103.5mm	41.16
NSYSBM154012H-Long	150	400	120	103.5mm	47.91
NSYSBM154012H-Short	150	400	120	103.5mm	47.91
NSYSBM202012H	200	200	120	103.5mm	40.16
NSYSBM203012H-Long	200	300	120	103.5mm	41.82
NSYSBM203012H-Short	200	300	120	103.5mm	41.82
NSYSBM204012H-Long	200	400	120	103.5mm	44.16
NSYSBM204012H-Short	200	400	120	103.5mm	44.16
NSYSBM205012H-Long	200	500	120	103.5mm	63.76
NSYSBM205012H-Short	200	500	120	103.5mm	73.24
NSYSBM206012H-Long	200	600	120	103.5mm	79.76
NSYSBM303012H	300	300	120	103.5mm	45.07
NSYSBM304012H-Long	300	400	120	103.5mm	47.29
NSYSBM304012H-Short	300	400	120	103.5mm	47.29
NSYSBM305012H-Long	300	500	120	103.5mm	73.53
NSYSBM305012H-Short	300	500	120	103.5mm	68.78
NSYSBM306012H-Long	300	600	120	103.5mm	85.89
NSYSBM306012H-Short	300	600	120	103.5mm	81.13
NSYSBM308012H-Long	300	800	120	103.5mm	104.91
NSYSBM404012H	400	400	120	103.5mm	60.51
NSYSBM405012H-Long	400	500	120	103.5mm	87.40
NSYSBM405012H-Short	400	500	120	103.5mm	87.40
NSYSBM406012H-Long	400	600	120	103.5mm	97.02
NSYSBM408012H-Long	400	800	120	103.5mm	107.18

Available in two depths - 80mm or 120mm the STB terminal box is rated at IP66. DIN Rail supports are not included and should be ordered separately if required.



STB151512

**IP66 RAL7035**

**Eldon Mild Steel STB Terminal Box - 80mm Deep**

REF NO	Dimensions (mm)			Internal Depth	PRICE	
	H	x	W			
STB151508	150	x	150	80	63.5mm	24.97
STB202008	200	x	200	80	63.5mm	29.26
STB153008	300	x	150	80	63.5mm	29.71
STB203008	300	x	200	80	63.5mm	31.55
STB303008	300	x	300	80	63.5mm	40.00
STB204008	400	x	200	80	63.5mm	36.73

**IP66 RAL7035**

**Eldon Mild Steel STB Terminal Box - 120mm Deep**

REF NO	Dimensions (mm)			Internal Depth	PRICE	
	H	x	W			
STB151512	150	x	150	120	103.5mm	27.82
STB202012	200	x	200	120	103.5mm	31.55
STB153012	150	x	300	120	103.5mm	32.44
STB203012	200	x	300	120	103.5mm	35.03
STB303012	300	x	300	120	103.5mm	42.56
STB204012	200	x	400	120	103.5mm	39.58
STB304012	300	x	400	120	103.5mm	46.58
STB404012	400	x	400	120	103.5mm	56.30
STB205012	200	x	500	120	103.5mm	44.14
STB305012	300	x	500	120	103.5mm	52.30
STB206012	200	x	600	120	103.5mm	48.14
STB306012	300	x	600	120	103.5mm	58.36
STB406012	400	x	600	120	103.5mm	66.15
STB208012	200	x	800	120	103.5mm	70.34
STB408012	400	x	800	120	103.5mm	78.36



**Mounting Plates for STB & SSTB Terminal Boxes**

REF NO	For Enclosure Size (mm)			Actual Plate Size (mm)			PRICE
	H	x	W	H	x	W	
BMP1515	150	x	150	125	x	120	5.14
BMP1530	150	x	300	125	x	270	6.88
BMP2020	200	x	200	170	x	170	6.88
BMP2030	200	x	300	170	x	270	8.49
BMP2040	200	x	400	170	x	370	10.64
BMP2050	200	x	500	170	x	470	13.17
BMP2060	200	x	600	170	x	570	15.76
BMP2080	200	x	800	170	x	770	25.21
BMP3030	300	x	300	275	x	270	11.63
BMP3040	300	x	400	275	x	370	14.56
BMP3050	300	x	500	275	x	470	18.48
BMP3060	300	x	600	275	x	570	22.67
BMP4040	400	x	400	380	x	370	20.49
BMP4060	400	x	600	380	x	570	26.83
BMP4080	400	x	800	380	x	770	32.93

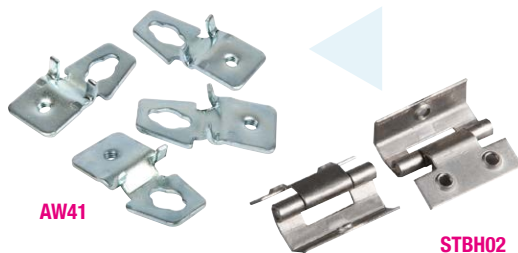

AW41

STBH02

**STB Accessories**

REF NO	Description	PRICE
AW41	Zinc Plated Mounting Brackets Supplied in Pack of 4	6.84
STBH02	Pair of Zinc Plated Hinges Machining Required	7.06

Need terminals for your terminal box?

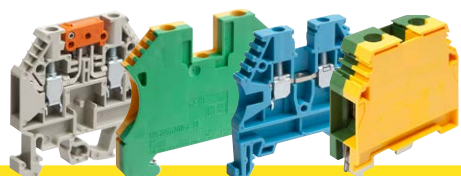

See pages 348-379 for our range

Available in two depths - 80mm or 120mm the SSTB terminal box is rated at IP66. DIN Rail supports are not included and should be ordered separately if required. Manufactured from AISI 304 Stainless Steel.

**IP66**

**Eldon Stainless Steel SSTB Terminal Box - 80mm Deep**

REF NO	Dimensions (mm)			Internal Depth	PRICE	
	H	x	W			
SSTB151508	150	x	150	80	63.5mm	118.59
SSTB202008	200	x	200	80	63.5mm	140.95
SSTB153008	300	x	150	80	63.5mm	143.09
SSTB203008	300	x	200	80	63.5mm	163.42
SSTB303008	300	x	300	80	63.5mm	187.83
SSTB204008	400	x	200	80	63.5mm	174.73



316L Grade Stainless Steel version also available

DIN Rail supports must be ordered separately

**IP66**

**Eldon Stainless Steel SSTB Terminal Box - 120mm Deep**

REF NO	Dimensions (mm)			Internal Depth	PRICE	
	H	x	W			
SSTB151512	150	x	150	120	103.5mm	139.81
SSTB202012	200	x	200	120	103.5mm	159.07
SSTB153012	150	x	300	120	103.5mm	164.55
SSTB203012	200	x	300	120	103.5mm	172.48
SSTB303012	300	x	300	120	103.5mm	199.82
SSTB204012	200	x	400	120	103.5mm	185.88
SSTB304012	300	x	400	120	103.5mm	228.11
SSTB404012	400	x	400	120	103.5mm	264.97
SSTB205012	200	x	500	120	103.5mm	204.47
SSTB305012	300	x	500	120	103.5mm	250.92
SSTB206012	200	x	600	120	103.5mm	224.92
SSTB306012	300	x	600	120	103.5mm	276.01
SSTB406012	400	x	600	120	103.5mm	304.72
SSTB208012	200	x	800	120	103.5mm	249.19
SSTB408012	400	x	800	120	103.5mm	335.19

**BPP Din Rail Supports for STB & SSTB Boxes**

REF NO	Description	PRICE
BPP15	Bottom Profile 150mm Wide	2.48
BPP20	Bottom Profile 200mm Wide	2.74
BPP30	Bottom Profile 300mm Wide	3.00
BPP40	Bottom Profile 400mm Wide	3.30
BPP50	Bottom Profile 500mm Wide	3.64
BPP60	Bottom Profile 600mm Wide	3.99
BPP80	Bottom Profile 800mm Wide	4.40

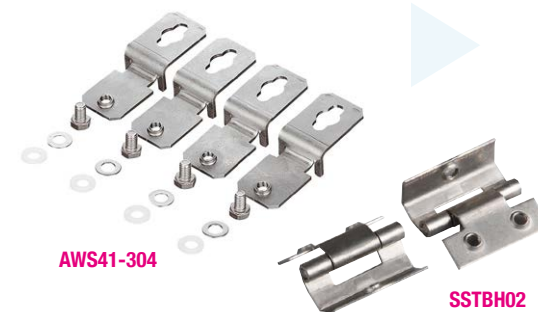

AWS41-304

SSTBH02

**SSTB Accessories**

REF NO	Description	PRICE
AWS41-304	Stainless Steel Mounting Brackets Supplied in Pack of 4	32.51
SSTBH02	Pair of Stainless Steel Hinges Machining Required	45.71



The NSYS3X range of stainless steel enclosures is specially suitable for corrosive environments and installations where hygiene is essential.

These monoblock solid sided IP66 enclosures are manufactured to both AISI 304L and AISI 316L stainless steel.



NSYS3X7525



**IP66**  
NSYS3X Wall Mounting Stainless Steel Enclosures with Glazed Door

REF NO	Dimensions (mm) H x W x D	Weight kg	No of Doors	PRICE
NSYS3X4320T	400 x 300 x 200	6.7	1	226.24
NSYS3X5420T	500 x 400 x 200	9.2	1	273.16
NSYS3X6420T	600 x 400 x 200	10.7	1	296.60
NSYS3X7525T	700 x 500 x 250	18.5	1	463.81
NSYS3X8625T	800 x 600 x 250	23.5	1	490.34
NSYS3X10830T	1000 x 800 x 300	38.5	1	745.93

**IP66**  
NSYS3X 304L Wall Mounting Stainless Steel Enclosures Single Door

REF NO	Dimensions (mm) H x W x D	Weight kg	No of Doors	PRICE
NSYS3X3215	300 x 200 x 150	3.9	1	150.53
NSYS3X302515	300 x 250 x 150	4.8	1	156.11
NSYS3X3315	300 x 300 x 150	5	1	160.87
NSYS3X4315	400 x 300 x 150	5.7	1	169.03
NSYS3X4320	400 x 300 x 200	6.7	1	184.96
NSYS3X4420	400 x 400 x 200	7	1	204.34
NSYS3X4620	400 x 600 x 200	9.1	1	256.64
NSYS3X5420	500 x 400 x 200	9.2	1	232.47
NSYS3X6420	600 x 400 x 200	10.7	1	255.69
NSYS3X6625	600 x 600 x 250	14	1	324.59
NSYS3X7525	700 x 500 x 250	18.5	1	393.58
NSYS3X8625	800 x 600 x 250	23.5	1	404.26
NSYS3X8830	800 x 800 x 300	31	1	535.36
NSYS3X10830	1000 x 800 x 300	38.5	1	626.41
NSYS3X12830	1200 x 800 x 300	44	1	740.93

**IP55**  
NSYS3X 304L Wall Mounting Stainless Steel Enclosures Double Door - 3 Point Locking System

REF NO	Dimensions (mm) H x W x D	Weight kg	No of Doors	PRICE
NSYS3X601030	600 x 1000 x 300	32	2	1358.24
NSYS3X601230	600 x 1200 x 300	35.5	2	1407.24
NSYS3X801030	800 x 1000 x 300	38.3	2	1332.58
NSYS3X801230	800 x 1200 x 300	43	2	1598.07
NSYS3X101030	1000 x 1000 x 300	44	2	1185.10
NSYS3X121030	1200 x 1000 x 300	54	2	1282.37



Mounting Plates for NSYS3X Enclosures Galvanised Steel

REF NO	Dimensions (mm)	Weight kg	Thickness mm	PRICE
NSYMM32	250 x 150	0.8	2	4.45
NSYMM3025	250 x 200	1	2	6.45
NSYMM33	250 x 250	1.4	2	6.63
NSYMM43	350 x 250	1.6	2	6.76
NSYMM44	350 x 350	2.2	2	11.55
NSYMM54	450 x 350	2.5	2	14.20
NSYMM64	550 x 350	3.1	2	15.03
NSYMM66	550 x 550	5.5	2	24.83
NSYMM75	650 x 450	4.6	2.5	24.83
NSYMM86	750 x 550	9.9	2.5	35.31
NSYMM88	750 x 750	13.6	2.5	42.87
NSYMM108	950 x 750	16.9	2.5	51.45
NSYMM1010	950 x 950	18.6	2.5	65.30
NSYMM128	1150 x 750	17.8	2.5	64.05
NSYMM1210	1150 x 950	21.44	2.5	85.31

Mounting plates to be ordered separately  
Mild steel internal doors NSYPIN\*\* are also available



**IP66**  
NSYS3X 316L Wall Mounting Stainless Steel Enclosures Single Door

REF NO	Dimensions (mm) H x W x D	Weight kg	No of Doors	PRICE
NSYS3X3215H	300 x 200 x 150	3.9	1	447.41
NSYS3X302515H	300 x 250 x 150	4.8	1	453.82
NSYS3X3315H	300 x 300 x 150	5	1	491.36
NSYS3X4315H	400 x 300 x 150	5.7	1	519.75
NSYS3X4320H	400 x 300 x 200	6.7	1	454.81
NSYS3X4420H	400 x 400 x 200	7	1	529.44
NSYS3X4620H	400 x 600 x 200	6.9	1	719.44
NSYS3X5420H	500 x 400 x 200	9.2	1	575.57
NSYS3X6420H	600 x 400 x 200	10.7	1	744.62
NSYS3X6625H	600 x 600 x 250	14	1	895.65
NSYS3X7525H	700 x 500 x 250	18.5	1	835.17
NSYS3X8625H	800 x 600 x 250	23.5	1	892.11
NSYS3X8830H	800 x 800 x 300	31	1	1185.91
NSYS3X10830H	1000 x 800 x 300	38.5	1	1432.46
NSYS3X12830H	1200 x 800 x 300	44	1	1794.06

Accessories for NSYS3X Stainless Steel Enclosures

REF NO	Description	PRICE
NSYPFCX	Stainless steel 304L wall fixing brackets	11.55
NSYPFC2X	Stainless steel 316L wall fixing brackets	15.20
NSYCL405CSX	Key lock with 405 Key	39.61
NSYCL1242ECSX	Key lock with 1242E Key	40.38
NSYSTDCSX	Standard DB lock	15.38



Stainless Steel Canopies for NSYS3X Stainless Enclosures

REF NO	Dimensions (mm) W x D x H	PRICE
NSYTX2015	205 x 183 x 51	94.77
NSYTX2515	255 x 183 x 51	94.97
NSYTX3015	305 x 183 x 51	101.88
NSYTX3020	305 x 233 x 51	121.02
NSYTX4020	405 x 233 x 70	133.21
NSYTX5025	505 x 283 x 70	157.16
NSYTX6020	605 x 233 x 70	152.99
NSYTX6025	605 x 283 x 70	160.92
NSYTX8030	805 x 333 x 70	166.29
NSYTX10030	1005 x 333 x 70	182.30
NSYTX12030	1205 x 333 x 70	300.90

**IP55**  
NSYS3X 316L Wall Mounting Stainless Steel Enclosures Double Door

REF NO	Dimensions (mm) H x W x D	Weight kg	No of Doors	PRICE
NSYS3X101030H	1000 x 1000 x 300	45	2	1883.34
NSYS3X121030H	1200 x 1000 x 300	57	2	1902.10

Front / Rear Plinth Sections for NSYS3X Enclosures

These plinths are supplied in two parts and need to be ordered separately. The front/rear sections comprise four corner pieces with removable covers. They are also available in 200mm heights.

REF NO	Material	Description	PRICE
NSYSPFX8100	AISI 304L	100mm High x 800mm Wide	314.01
NSYSPFX10100	AISI 304L	100mm High x 1000mm Wide	305.99
NSYSPFX8100H	AISI 316L	100mm High x 800mm Wide	368.50
NSYSPFX10100H	AISI 316L	100mm High x 1000mm Wide	431.03

Side Plinth Sections for NSYS3X Enclosures

REF NO	Material	Description	PRICE
NSYSPSX3100	AISI 304L	100mm High x 300mm Deep	73.59
NSYSPSX3100H	AISI 316L	100mm High x 300mm Deep	88.16

The Eldon ASR range have a single door and are rated to IP66 / NEMA 4X, 12 13 IK10.

The ADR range have double doors and are rated to IP55 / NEMA 4X 12 13 IK10.

The enclosures are manufactured from pre-grained stainless steel AISI304L and AISI316L. These enclosures are particularly suited for harsh, demanding environments such as the food, offshore and chemical industries.



ASR0608030

## IP55 Eldon Stainless Steel Wall Mounted Enclosures Double Door

REF NO	Dimensions (mm)			Weight kg	PRICE
	H	x W	x D		
ADR1001030	1000	x 1000	x 300	59.5	941.37
ADR1001230	1000	x 1200	x 300	69.7	1035.51
ADR1201240	1200	x 1200	x 400	87.7	1346.16



ADR1201240

## Eldon Stainless Steel Internal Door

Inner doors for ASR 304L Enclosures. The usable depth between inner and external door is 35mm.

REF NO	Suitable for Enclosure size (mm)		No. of locks	PRICE
	H	x W		
ADIS04030	400	x 300	1	112.95
ADIS05040	500	x 400	1	124.28
ADIS05050	500	x 500	1	132.51
ADIS06040	600	x 400	1	128.75
ADIS06060	600	x 600	1	154.55
ADIS08060	800	x 600	2	185.98
ADIS10080	1000	x 800	2	309.34
ADIS12080	1200	x 800	2	440.61

## Accessories for ASR / ADR Stainless Steel Enclosures

REF NO	Description	PRICE
AWS41-304	Pack of 4 Stainless steel wall fixing lugs	32.51
AWS41-316	Pack of 4 Stainless steel 316 wall fixing lugs	33.62

Enclosures up to 500mm high have a single lock.  
Enclosures over 500mm high and up to 800mm x 800mm have two locks.

Enclosures 1000mm high and 1200mm high have a three point locking system.

All are supplied complete with a mounting plate.

Glazed internal door with clear glass also available (ADCS\*\*\*\*\*)

## IP66 Eldon Stainless Steel Wall 304L Mounted Enclosures Single Door

REF NO	Dimensions (mm)			Weight kg	PRICE
	H	x W	x D		
ASR0182415	180	x 240	x 150	2.5	163.08
ASR0242415	240	x 240	x 150	3.2	260.93
ASR0243615	240	x 360	x 150	5	188.55
ASR0302015	300	x 200	x 150	4.5	179.65
ASR0362415	360	x 240	x 150	5	190.45
ASR0403015	400	x 300	x 150	8.3	201.25
ASR0403021	400	x 300	x 210	9.5	223.61
ASR0404021	400	x 400	x 210	11.2	247.46
ASR0406021	400	x 600	x 210	15.8	307.59
ASR0504021	500	x 400	x 210	16	286.05
ASR0505021	500	x 500	x 210	17	320.16
ASR0604021	600	x 400	x 210	15.8	308.49
ASR0606021	600	x 600	x 210	22.2	391.52
ASR0606030	600	x 600	x 300	25.2	467.18
ASR0608030	600	x 800	x 300	32.4	549.62
ASR0806021	800	x 600	x 210	28.6	458.02
ASR0806030	800	x 600	x 300	32.3	555.12
ASR0808030	800	x 800	x 300	42	659.43
ASR1008030	1000	x 800	x 300	51.5	735.58
ASR1208030	1200	x 800	x 300	59.5	846.32
ASR1208040	1200	x 800	x 400	62.3	930.95
ASR1408040	1400	x 800	x 400	78.1	1024.04



ASR0606021-316

## IP66 Eldon Stainless Steel Wall 316L Mounted Enclosures Single Door

REF NO	Dimensions (mm)			Weight kg	PRICE
	H	x W	x D		
ASR0182415-316	180	x 240	x 150	2.5	260.93
ASR0242415-316	240	x 240	x 150	3.2	280.56
ASR0243615-316	240	x 360	x 150	5	301.68
ASR0302015-316	300	x 200	x 150	4.5	283.95
ASR0362415-316	360	x 240	x 150	5	304.72
ASR0403015-316	400	x 300	x 150	8.3	322.00
ASR0403021-316	400	x 300	x 210	9.6	380.97
ASR0404021-316	400	x 400	x 210	11.2	392.43
ASR0406021-316	400	x 600	x 210	15.8	492.14
ASR0504021-316	500	x 400	x 210	16	457.68
ASR0505021-316	500	x 500	x 210	17	512.26
ASR0604021-316	600	x 400	x 210	15.8	493.58
ASR0606021-316	600	x 600	x 210	22.2	651.05
ASR0606030-316	600	x 600	x 300	25.2	747.49
ASR0608030-316	600	x 800	x 300	32.4	879.39
ASR0806021-316	800	x 600	x 210	28.6	732.83
ASR0806030-316	800	x 600	x 300	32.3	888.19
ASR0808030-316	800	x 800	x 300	42	1055.09
ASR1008030-316	1000	x 800	x 300	51.5	1176.93
ASR1208030-316	1200	x 800	x 300	59.5	1354.11
ASR1208040-316	1200	x 800	x 400	62.3	1489.52
ASR1408040-316	1400	x 800	x 400	78.1	1638.46

## IP55 Eldon Stainless Steel Wall Mounted Enclosures Double Door

REF NO	Dimensions (mm)			Weight kg	PRICE
	H	x W	x D		
ADR1001030-316	1000	x 1000	x 300	59.5	1506.19
ADR1001230-316	1000	x 1200	x 300	69.7	1656.82
ADR1201240-316	1200	x 1200	x 400	87.7	2153.85

## IP66 Eldon Stainless Steel Wall Mounted Enclosures with Integrated Rain Hood

REF NO	Dimensions (mm)			Weight kg	PRICE
	H	x W	x D		
AFS03021	300	x 200	x 155	4.6	213.79
AFS04031	400	x 300	x 155	7.9	285.05
AFS04042	400	x 400	x 210	11.1	316.84
AFS04062	400	x 600	x 210	15.8	396.05
AFS05052	500	x 500	x 210	16	400.05
AFS06042	600	x 400	x 210	15.4	400.05
AFS06062	600	x 600	x 210	21.9	462.25
AFS06063	600	x 600	x 300	24.6	491.76
AFS06083	600	x 800	x 300	31.1	607.92
AFS08062	800	x 600	x 210	28.4	553.41
AFS08063	800	x 600	x 300	31.3	605.68
AFS08082	800	x 800	x 210	37.3	645.73
AFS08083	800	x 800	x 300	39.1	795.52
AFS10083	1000	x 800	x 300	51.8	872.01
AFS12063	1200	x 600	x 300	47.2	876.37
AFS12083	1200	x 800	x 300	60.1	948.50
AFS12084	1200	x 800	x 400	65.1	1043.35
AFS14084	1400	x 800	x 400	73.4	1108.79



AFS06042

## Eldon Enclosure Accessories

REF NO	Description	PRICE
ALT560	Plastic Handle	14.95
ALT561	Chrome Plated T Handle - Key Lock	35.27
ALT562	Wing Knob 333 Key-lock	34.67
BFP7035	Touch-up Paint RAL7035 - 400ml	22.53
ADO202	Door Stop to secure door in open position at 90° or 110° Zinc Plated	8.93
ADSW01	Multimount Door Switch	32.08

ADSW01



ALT560



A range of glass fibre reinforced polyester (GRP) cabinets with a single piece monoblock body. Glass reinforced polyester is self extinguishing composite material that is resistant to corrosion, principal chemical and atmospheric agents. It is also stable to ultra violet light.

NSYPLMG enclosures have good resistance to mechanical impacts - IK-10 (20J) and a wide temperature tolerance of -50°C to +130°C making them extremely suitable for exterior use and damp environments where they will NEVER RUST!

NSYPLMG enclosures have UL certification and NEMA 4x and 13. They are fully insulated to produce Class II units according to IEC61439-1.

**IP66 RAL7035**  
Thalassa NSYPLMG Wall Mounting Enclosure with Grey Door - 3 Point Locking

REF NO	Dimensions (mm)			Weight kg	PRICE
	H	x W	x D		
NSYPLM43VG	430	x 330	x 200	5.1	156.44
NSYPLM54VG	530	x 430	x 200	7.48	201.33
NSYPLM64VG	647	x 436	x 250	10	235.89
NSYPLM75VG	747	x 536	x 300	14.5	278.86
NSYPLM86VG	847	x 636	x 300	17.5	358.59
NSYPLM108G	1056	x 852	x 350	32	465.03



NSYPLM108G

**IP66 RAL7035**  
Thalassa NSYPLMG Wall Mounting Enclosure with Grey Door

REF NO	Dimensions (mm)			Weight kg	Locks	PRICE
	H	x W	x D			
NSYPLM32G	310	x 215	x 160	1.51	1	50.96
NSYPLM3025G	308	x 255	x 160	3.24	2	71.60
NSYPLM43G	430	x 330	x 200	5.1	2	88.20
NSYPLM54G	530	x 430	x 200	7.48	2	117.51
NSYPLM64G	647	x 436	x 250	10	2	129.59
NSYPLM75G	747	x 536	x 300	14.5	2	199.22
NSYPLM86G	847	x 636	x 300	17.5	2	256.14
NSYPLM108G	1056	x 852	x 350	32	1	465.03

**i** The NSYPLM32G is manufactured from Polycarbonate



NSYPLM108G

NSYPLM3025G

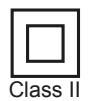

Class II

**Pole Clamps**

The pole clamp allows the enclosure to be fixed to concrete, wood or aluminium posts up to a diameter of 675mm. Supplied with galvanised steel fixing loop and profiles which attach to the back of the enclosure using M8 screws into inserts (provided).

Recommended maximum weight of installation is 100kg

REF NO	Description	PRICE
NSYSFP300	For attachment of PLM43G	61.60
NSYSFP400	For attachment of PLM54G & PLM64G	61.60
NSYSFP500	For attachment of PLM75G	63.86
NSYSFP600	For attachment of PLM86G	63.86



NSYSFP\*\*

**Mounting Plates for Thalassa NSYPLMG Enclosures - Galvanised Steel**

REF NO	Dimensions mm	Weight kg	Thickness mm	PRICE
NSYMM32	250 x 150	0.9	2	4.45
NSYMM3025	250 x 200	1	2	6.45
NSYMM43	350 x 250	1.6	2	6.76
NSYMM54	450 x 350	2.5	2	14.20
NSYMM64	550 x 350	3.1	2	15.04
NSYMM75	650 x 450	4.6	2.5	24.83
NSYMM86	750 x 550	9.9	2.5	35.31
NSYMM108	950 x 750	16.9	2.5	51.45



NSYMM\*\*

**Mounting Plates for Thalassa NSYPLMG Enclosures - Polyester**

REF NO	Dimensions mm	Weight kg	Thickness mm	PRICE
NSYMB3025	265 x 200	0.5	2	6.25
NSYMB43	365 x 350	1.1	2	10.77
NSYMB54	465 x 350	1.3	2	15.72
NSYMB64	565 x 350	1.6	2	19.48
NSYMB75	665 x 450	2.3	2	26.69
NSYMB86	765 x 550	4.5	2.5	36.52
NSYMB108	965 x 750	7	2.5	93.02



NSYMB\*\*

**i** Mounting plates are not included and should be ordered separately

**Adjustable Mounting Plate Support**

REF NO	Description	PRICE
NSYDPLM200	Support for PLM43G and PLM54G	27.03
NSYDPLM250	Support for PLM64G	28.95
NSYDPLM300	Support for PLM75G and PLM86G	45.20
NSYDPLM350	Support for PLM108G	45.21

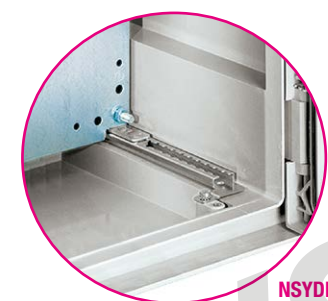

NSYDPLM\*\*

**NSYPLMG Accessories**

REF NO	Description	PRICE
NSYFPPLM32G	Wall fixing brackets for NSYPLM32G only Set of 4	4.39
NSYFPPLMG	Wall fixing brackets for NSYPLMG enclosures; Set of 4	5.31
NSYTC8CRN	8mm Square lock for PLM32G - PLM86G	16.14
NSYTT8CRN	8mm Triangular lock for PLM32G - PLM86G	8.09
NSYTC7CRN	7mm Square lock for PLM32G - PLM86G	11.53
NSYTL405PLM	Wing lock with 405 key for PLM32G - PLM86G	16.09
NSYTHL405PLM	Handle Keylock with 405 key for PLM32G - PLM86G	16.14
NSYKPLM	Stainless padlock hasp for PLM32G - PLM86G	17.60
NSYBCPL	Stainless padlock hasp for PLM108G	24.22
NSYTCL405ME	Three point 405 key lock for PLM xxx VG	22.07
NSYTEL405PL	Handle lock with 405 key for PLM108G	54.11
NSYBCME	Padlock for Handle lock on PLM108G and three point locking enclosures	50.78
NSYDCBPLM	Replacement Double Bit Lock	6.65
NSYDBP	Spare Double Bar Key - Plastic	1.40



NSYFPPLMG

NSYKPLM



The NSYPLMTG glazed door version meet the same standards as the grey door with the exception of the Impact Resistance which is IK08.

## IP66 RAL7035

Thalassa NSYPLMTG Wall Mounted Enclosure with Transparent Door

REF NO	Dimensions (mm) H x W x D	Weight kg	Locks	PRICE
NSYPLM32TG	310 x 215 x 160	2	1	80.12
NSYPLM3025TG	308 x 255 x 160	4	2	93.11
NSYPLM43TG	430 x 330 x 200	6	2	112.77
NSYPLM54TG	530 x 430 x 200	8	2	150.30
NSYPLM64TG	647 x 436 x 250	10.5	2	203.67
NSYPLM75TG	747 x 536 x 300	16.5	2	253.66
NSYPLM86TG	847 x 636 x 300	18	2	332.88
NSYPLM108TG	1056 x 852 x 350	33.5	1	502.71

The NSYPLM32TG is manufactured from Polycarbonate and has a fully transparent door



NSYPLM54TG



### NSYPLMTG Accessories

REF NO	Description	PRICE
NSYFPFLM32G	Wall fixing brackets for NSYPLM32G only Set of 4	4.39
NSYFPFLMG	Wall fixing brackets for NSYPLMG enclosures; Set of 4	5.31
NSYTC8CRN	8mm Square lock for PLM32G - PLM86G	16.14
NSYTT8CRN	8mm Triangular lock for PLM32G - PLM86G	8.09
NSYTC7CRN	7mm Square lock for PLM32G - PLM86G	11.53
NSYTL405PLM	GWing lock with 405 key for PLM32G -PLM86G	16.09
NSYKPLM	Stainless padlock hasp for PLM32G - PLM86G	17.60
NSYTCL405ME	Three point 405 key lock for PLM xxx VG	22.07
NSYTEL405PL	Handle lock with 405 key for PLM108G	54.11
NSYBCME	Padlock for Handle lock on PLM108G and three point locking enclosures	50.78
NSYDCBPLM	Replacement Double Bit Lock	6.65
NSYDBP	Spare Double Bar Key - Plastic	1.40

### Mounting Plates for Thalassa NSYPLMTG Enclosures Galvanised Steel

REF NO	Dimensions mm	Weight kg	Thickness mm	PRICE
NSYMM32	250 x 150	0.9	2	4.45
NSYMM3025	250 x 200	1	2	6.45
NSYMM43	350 x 250	1.6	2	6.76
NSYMM54	450 x 350	2.5	2	14.20
NSYMM64	550 x 350	3.1	2	15.04
NSYMM75	650 x 450	4.6	2.5	24.83
NSYMM86	750 x 550	9.9	2.5	35.31
NSYMM108	950 x 750	16.9	2.5	51.45

NSYMM\*\*



### Mounting Plates for Thalassa NSYPLMTG Enclosures Polyester

REF NO	Dimensions mm	Weight kg	Thickness mm	PRICE
NSYMB3025	265 x 200	0.5	2	6.25
NSYMB43	365 x 250	1.1	2	10.77
NSYMB54	465 x 350	1.3	2	15.72
NSYMB64	565 x 350	1.6	2	19.48
NSYMB75	665 x 450	2.3	2	26.69
NSYMB86	765 x 550	4.5	2.5	36.52
NSYMB108	965 x 750	7	2.5	93.02

NSYMB\*\*

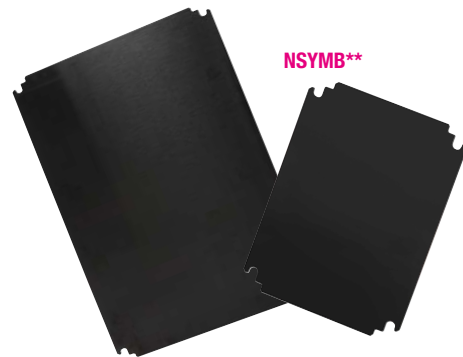

Mounting plates are not included and should be ordered separately for the NSYPLMG range

## RAL7035

### Internal Door for Thalassa NSYPLMG Enclosures

REF NO	For Enclosure Size (mm)		Usable Door Area (mm)		PRICE
	H	W	H	W	
NSYPA3025PLMG	308	255	248	165	62.53
NSYPAP43G	430	330	315	205	29.99
NSYPAP54G	530	430	415	305	34.15
NSYPAP64G	647	436	515	305	39.46
NSYPAP75G	747	536	615	405	46.19
NSYPAP86G	847	636	715	505	64.12
NSYPAP108G	1056	852	850	650	194.54

The NSYPA3025PLMG is manufactured from Mild Steel, the other sizes are Polyester



NSYPAP64G

Class II

### Air Vents

REF NO	Description	PRICE
NSYCAG19LP	Air Vent - 19mm Diameter cut-out - IP45	2.34/Pk2
NSYCAG33LP	Air Vent - 33mm Diameter cut-out - IP44	15.50/Pk2
NSYCAG35LP	Air Vent - 35mm Diameter cut-out - IP44	4.78



NSYCAG35LP



NSYCAG33LP



NSYTCSPLM

### DIN Rail & Rail Fixing Support

REF NO	Description	PRICE
NSYTCSPLM	Insert nuts specifically designed to fit the back of the enclosure for quick fixing of DIN rail without the requirement for a backplate. (Pk/20)	15.60

## RAL7035

### Floor Mounting Pillar

REF NO	Description	PRICE
NSYSFSPLMG	The floor mounting pillar elevates the enclosure and also protects the cables entering the enclosure. Supplied with a steel frame for fixing to the floor. Cable entry section - 165 x 100mm	257.29

The NSYSFSPLMG is suitable for NSYPLM54G and NSYPLM64G enclosures.

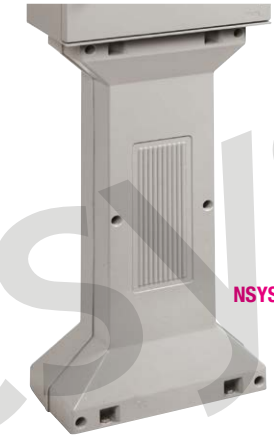

NSYSFSPLMG



### Plinths for NSYPLM75G, NSYPLM86G & NSYPLM108G

REF NO	Description	PRICE
NSYZM253G	200mm Plinth for NSYPLM75G	139.51
NSYZM263G	200mm Plinth for NSYPLM86G	166.34
NSYZM283G	200mm Plinth for NSYPLM108G	231.79
NSYAC280	Cross-rail Cable Support for NSYZM253G	28.27
NSYAC360	Cross-rail Cable Support for NSYZM263G	31.14
NSYAC600	Cross-rail Cable Support for NSYZM283G	30.74



NSYAC\*\*\*

The Fibox ARCA wall mounting enclosures are manufactured from high grade, UV stabilised polycarbonate.

The IP 66; IK 10 enclosures meet the Low Voltage Directive 2006/95/EC up to 1500VDC and the raw material flammability rating is UL94-5VA.

There is a complete range of ancillary products and accessories to compliment the enclosures.

Fibox ARCA enclosures are supplied complete with a mounting plate.



ARCA403021

**IP66 RAL7035**  
Fibox ARCA Polycarbonate Enclosures with Window in Door with 3-Bit Lock(s)

REF NO	Dimensions (mm) H x W x D	No. of Locks	PRICE
ARCA203015W	200 x 300 x 150	1	80.17
ARCA302015W	300 x 200 x 150	1	77.28
ARCA304015W	300 x 400 x 150	1	106.32
ARCA304021W	300 x 400 x 210	1	122.75
ARCA403015W	400 x 300 x 150	2	103.20
ARCA403021W	400 x 300 x 210	2	118.89
ARCA405021W	400 x 500 x 210	2	164.77
ARCA406021W	400 x 600 x 210	2	183.85
ARCA504021W	500 x 400 x 210	2	162.55
ARCA604021W	600 x 400 x 210	2	185.30
ARCA507030W	500 x 700 x 300	2	331.20
ARCA608030W	600 x 800 x 300	2	407.03
ARCA705030W	700 x 500 x 300	2	330.08
ARCA806030W	800 x 600 x 300	2	406.63



IDS ARCA \*\*\*\*

**IP66 RAL7035**  
Fibox ARCA Polycarbonate Enclosures Grey Door with 3-Bit Lock(s)

REF NO	Dimensions (mm) H x W x D	No. of Locks	PRICE
ARCA203015	200 x 300 x 150	1	51.38
ARCA302015	300 x 200 x 150	1	51.41
ARCA304015	300 x 400 x 150	1	76.66
ARCA304021	300 x 400 x 210	1	91.98
ARCA403015	400 x 300 x 150	2	77.01
ARCA403021	400 x 300 x 210	2	92.67
ARCA405021	400 x 500 x 210	2	127.35
ARCA406021	400 x 600 x 210	2	143.28
ARCA504021	500 x 400 x 210	2	126.11
ARCA604021	600 x 400 x 210	2	141.99
ARCA507030	500 x 700 x 300	2	294.91
ARCA608030	600 x 800 x 300	2	348.13
ARCA705030	700 x 500 x 300	2	294.91
ARCA806030	800 x 600 x 300	2	348.14

**RAL7035**  
Fibox ARCA Internal Doors - Steel

REF NO	Description	PRICE
IDS ARCA 3020	For ARCA3020	66.33
IDS ARCA 4030	For ARCA4030	85.01
IDS ARCA 5040	For ARCA5040	95.31
IDS ARCA 6040	For ARCA6040	103.04
IDS ARCA 7050	For ARCA7050	133.49
IDS ARCA 8060	For ARCA8060	164.66



IDS ARCA 4030

**Fibox ARCA DIN Rail Frame Kits**

The kit enables modular devices such as breakers to be mounted in the enclosure. Each kit consists of a DIN rail frame, a front plate and corner brackets which enable quick and easy mounting into the enclosure

REF NO	Description	PRICE
DRS ARCA302015	1 Row of 5 Modules	49.10
DRS ARCA403015	2 Rows of 11 Modules	64.29
DRS ARCA403021	2 Rows of 11 Modules	64.29
DRS ARCA504021	3 Rows of 16 Modules	74.16
DRS ARCA604021	3 Rows of 16 Modules	100.57
DRS ARCA705030	4 Rows of 21 Modules	86.86
DRS ARCA806030	4 Rows of 26 Modules	129.30
DRS ARCA203015	1 Row of 11 Modules	49.10
DRS ARCA304015	1 Row of 16 Modules	64.29
DRS ARCA304021	1 Row of 16 Modules	56.67
DRS ARCA405021	2 Rows of 22 Modules	83.07
DRS ARCA406021	2 Rows of 27 Modules	100.57
DRS ARCA507030	3 Rows of 32 Modules	99.55
DRS ARCA608030	3 Rows of 37 Modules	104.48



**Fibox ARCA Enclosure Accessories**

REF NO	Description	PRICE
WMK ARCA10SMALL	Set of four wall fixing lugs For ARCA203015 to ARCA608030	24.53
WMK ARCA10MID	Set of four wall fixing lugs For ARCA705030 to ARCA806030	24.53
LIS ARCA 405E	Replacement lock with 405E Key	17.61
LIS ARCA 1242E	Replacement lock with 1242E Key	17.55



WMK ARCA10

**Fibox ARCA Corner Adjustment (Set of 4)**

The corner adjustment set allows the mounting plate to be adjusted to the depth required inside the enclosure

REF NO	Description	PRICE
CBS ARCA 15	For 150mm Deep Enclosures	17.87
CBS ARCA 21	For 210mm Deep Enclosures	18.95
CBS ARCA 30	For 300mm Deep Enclosures	21.80

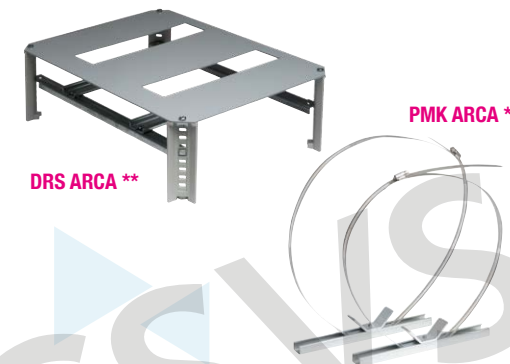

DRS ARCA \*\*

PMK ARCA \*\*

The corner adjustment set allows for 10mm increments

**Fibox ARCA Pole Mounting Kits**

REF NO	Description	PRICE
PMK ARCA 20	For 200mm Wide Enclosures	48.65
PMK ARCA 30	For 300mm Wide Enclosures	49.53
PMK ARCA 40	For 400mm Wide Enclosures	50.87
PMK ARCA 50	For 500mm Wide Enclosures	52.33
PMK ARCA 60	For 600mm Wide Enclosures	59.24

**Zero Halogen Trunking** **NEW!**

See page 129

**IBOCO**

The range of Pedro VTR polyester enclosures from Bocchiotti are rated to IP66 and are available in both solid and clear door versions. The innovative design along with robust construction is the perfect enclosure for all environments.

The range of enclosures are suitable for assembled units complying with standard CEI 17-13/1.

A full range of accessories are available to compliment your Pedro enclosure.

**IP66 RAL7035**  
Bocchiotti PEDRO VTR Polyester Wall Mounting Enclosures - Clear Polycarbonate Door

REF NO	Dimensions (mm) H x W x D	No. of Locks	PRICE
VTR010 / B04621	300 x 265 x 165	1	71.00
VTR020 / B04622	425 x 325 x 180	2	99.74
VTR030 / B04623	500 x 430 x 210	2	159.06
VTR040 / B04624	650 x 430 x 210	2	190.80
VTR050 / B04625	650 x 540 x 260	2	218.24
VTR060 / B04626	805 x 615 x 315	2	342.97
VTR070 / B04627	1060 x 810 x 355	2	422.05



VTR07C



VTR070

**IP66 RAL7035**  
Bocchiotti PEDRO VTR Polyester Wall Mounting Enclosures - Grey Door

REF NO	Dimensions (mm) H x W x D	No. of Locks	PRICE
VTR01C / B04601	300 x 265 x 165	1	51.11
VTR02C / B04602	425 x 325 x 180	2	66.09
VTR03C / B04603	500 x 430 x 210	2	92.84
VTR04C / B04604	650 x 430 x 210	2	106.71
VTR05C / B04605	650 x 540 x 260	2	120.74
VTR06C / B04606	805 x 615 x 315	2	192.19
VTR07C / B04607	1060 x 810 x 355	2	310.51

**PEDRO VTR Wall Mounting Brackets**

Wall mounting brackets are available in both Stainless Steel and Zinc plated. 4 brackets per pack. Vertical/horizontal mounting.

REF NO	Description	PRICE
<b>Zinc Plated</b>		
STVTR / B04680	For VTR Enclosures	6.90
<b>Stainless steel 304 AISI</b>		
PFVTR / B04688	For VTR Enclosures	14.41

**PEDRO VTR Internal Doors - Mild Steel**

REF NO	Description	PRICE
CP02 / B04631	CP02 Internal Door for VTR02	35.95
CP03 / B04632	CP03 Internal Door for VTR03	40.68
CP04 / B04633	CP04 Internal Door for VTR04	47.29
CP05 / B04634	CP05 Internal Door for VTR05	52.98
CP06 / B04635	CP06 Internal Door for VTR06	66.12
CP07 / B04637	CP07 Internal Door for VTR07	118.92

VTR030 WITH CP03



STVTR

**Mounting Plates for PEDRO VTR Enclosures**

REF NO	Dimensions mm	Thickness mm	PRICE
<b>Galvanised Steel</b>			
PFVTR01 / B04670	240 x 199	1.5	4.79
PFVTR02 / B04671	365 x 242	1.5	7.97
PFVTR03 / B04672	440 x 350	1.5	13.69
PFVTR04 / B04673	590 x 350	2	16.88
PFVTR05 / B04674	590 x 458	2	17.70
PFVTR06 / B04675	740 x 530	2	34.03
PFVTR07 / B04676	990 x 710	2	50.55
<b>Polyester</b>			
PFVTR01IS / B04690	240 x 199	4	8.64
PFVTR02IS / B04691	365 x 242	4	13.69
PFVTR03IS / B04692	440 x 350	4	19.73
PFVTR04IS / B04693	590 x 350	4	23.56
PFVTR05IS / B04694	590 x 458	4	36.15
PFVTR06IS / B04695	740 x 530	4	56.63

Polyester backplates for VTR07 are available as a made to order part. Please contact us for more information.



PFVTR02

**PEDRO VTR Pole Mounting Kit**

REF NO	Description	PRICE
FIAP1 / B04581	Pole Mounting Kit For VTR01	57.37
FIAP2 / B04582	Pole Mounting Kit For VTR02	62.52
FIAP3-4 / B04583	Pole Mounting Kit For VTR03/04	71.19
FIAP5 / B04584	Pole Mounting Kit For VTR05	77.13
FIAP6 / B04585	Pole Mounting Kit For VTR06	86.48

**Accessories for PEDRO VTR Enclosures**

REF NO	Description	PRICE
SRVTR / B04681	Replacement Key Lock	10.94
SRORPF / B04682	Mounting Plate Adjustment Device	5.20



Pedro VTR Polyester enclosures are pre-fitted with depth adjustment profiles

**PEDRO VTR Module DIN Rail Assembly**

The DIN rail assembly can be mounted directly into the enclosure. For ease of installation a vertical frame can be used to allow for panels to be assembled separately. DIN Rail assemblies are sold as individual units, if you require more than one rail these should be ordered separately.

REF NO	Description	Maximum Rails Per Enclosure	PRICE
<b>DIN Rail Assembly</b>			
GUIDE12 / B04660	For VTR02 Enclosures	3	7.90
GUIDE18 / B04661	For VTR03/04 Enclosures	4	9.43
GUIDE24 / B04662	For VTR05 Enclosures	4	11.62
GUIDE28 / B04663	For VTR06 Enclosures	5	13.26
GUIDE38 / B04664	For VTR07 Enclosures	5	17.51

**Vertical Frame**

MONT02 / B04651	For VTR02 Enclosures	1	6.57
MONT03 / B04652	For VTR03/04 Enclosures	1	7.16
MONT04-05 / B04653	For VTR05 Enclosures	1	7.56
MONT06 / B04654	For VTR06 Enclosures	1	10.80
MONT07 / B04655	For VTR07 Enclosures	1	17.96



B04661

B04663

# Schneider NSYPLAG Polyester Floor Standing Enclosures

# Schneider NSYPLATG Polyester Floor Standing Enclosures

The NSYPLAG range of modular enclosures are manufactured from Glass Fibre Reinforced Polyester, a self extinguishing composite material to IEC695-2-1, resistant to corrosion, principal chemical and atmospheric agents. It is also stable to ultra violet light.

The temperature range for the NSYPLAG enclosures is -50°C to +130°C and the standard range is IP65; IK10 (20J).

Doors are reversible with 120° opening and feature a 4 point locking system. Door stays are available as are a complete range of accessories for this very versatile enclosure range. These enclosures can also be wall mounted with use of NSYFMPA.



## IP65 RAL7035

### Thalassa NSYPLAG Single Plain Grey Door Solid Top & Bottom

REF NO	Dimensions (mm)			Weight kg	PRICE
	H	x W	x D		
NSYPLA553G	500	x 500	x 320	13.5	279.24
NSYPLA554G	500	x 500	x 420	17.36	307.73
NSYPLA573G	500	x 750	x 320	18.41	301.17
NSYPLA574G	500	x 750	x 420	23.67	329.38
NSYPLA753G	750	x 500	x 320	18.41	301.17
NSYPLA754G	750	x 500	x 420	23.67	329.83
NSYPLA773G	750	x 750	x 320	25.1	383.65
NSYPLA774G	750	x 750	x 420	27.06	396.99
NSYPLA776G	750	x 750	x 620	29	475.64
NSYPLA1053G	1000	x 500	x 320	27.3	396.65
NSYPLA1054G	1000	x 500	x 420	29.45	410.60
NSYPLA1073G	1000	x 750	x 320	28.38	470.57
NSYPLA1074G	1000	x 750	x 420	36.49	490.03
NSYPLA1253G	1250	x 500	x 320	28.7	488.47
NSYPLA1254G	1250	x 500	x 420	34.9	463.99
NSYPLA1273G	1250	x 750	x 320	35	548.28
NSYPLA1274G	1250	x 750	x 420	38	537.12
NSYPLA1276G	1250	x 750	x 620	45	606.16
NSYPLA1553G	1500	x 500	x 320	30.7	477.21
NSYPLA1554G	1500	x 500	x 420	39.5	509.23
NSYPLA1573G	1500	x 750	x 320	41.5	540.96
NSYPLA1574G	1500	x 750	x 420	53.9	565.96
NSYPLA1576G	1500	x 750	x 620	48	622.09

## IP65 RAL7035

### Thalassa NSYPLAG Double Plain Grey Door Solid Top & Bottom

REF NO	Dimensions (mm)			Weight kg	PRICE
	H	x W	x D		
NSYPLA5103G	500	x 1000	x 320	27.3	502.06
NSYPLA5104G	500	x 1000	x 420	27.45	496.43
NSYPLA5123G	500	x 1250	x 320	30.68	483.83
NSYPLA5124G	500	x 1250	x 420	37.45	544.93
NSYPLA7103G	750	x 1000	x 320	28.38	502.06
NSYPLA7104G	750	x 1000	x 420	36.49	548.03
NSYPLA7123G	750	x 1250	x 320	33.79	564.70
NSYPLA7124G	750	x 1250	x 420	43.44	634.53
NSYPLA10103G	1000	x 1000	x 320	39.73	618.40
NSYPLA10104G	1000	x 1000	x 420	51.08	669.08
NSYPLA10123G	1000	x 1250	x 320	47.3	676.67
NSYPLA10124G	1000	x 1250	x 420	60.8	755.24
NSYPLA12103G	1250	x 1000	x 320	51	706.52
NSYPLA12104G	1250	x 1000	x 420	56	749.57
NSYPLA12123G	1250	x 1250	x 320	58	834.05
NSYPLA12124G	1250	x 1250	x 420	62.5	874.89
NSYPLA12126G	1250	x 1250	x 620	75	959.16
NSYPLA15103G	1500	x 1000	x 320	58.6	793.54
NSYPLA15104G	1500	x 1000	x 420	75.4	838.14
NSYPLA15123G	1500	x 1250	x 320	70	923.15
NSYPLA15124G	1500	x 1250	x 420	78	956.17
NSYPLA15126G	1500	x 1250	x 620	94	1061.62
NSYPLA2074G	2000	x 750	x 420	62	962.51



Enclosures up to 750mmH have 2 hinges per door.  
Enclosures 1000mmH and over have 4 hinges  
500mm & 750mmW enclosures have one door  
1000mmW enclosures have 2 x 500mmW doors  
1250mmW enclosures have 1 x 750mmW and 1 x 500mmW door

## IP65 RAL7035

### Thalassa NSYPLATG Single Plain Glazed Door Solid Top & Bottom

REF NO	Dimensions (mm)			Weight kg	PRICE
	H	x W	x D		
NSYPLA553TG	500	x 500	x 320	13.5	373.16
NSYPLA554TG	500	x 500	x 420	17.36	399.97
NSYPLA573TG	500	x 750	x 320	18.41	417.02
NSYPLA574TG	500	x 750	x 420	23.67	428.00
NSYPLA753TG	750	x 500	x 320	18.41	403.40
NSYPLA754TG	750	x 500	x 420	23.67	428.14
NSYPLA773TG	750	x 750	x 320	25.1	498.56
NSYPLA774TG	750	x 750	x 420	27.06	515.87
NSYPLA776TG	750	x 750	x 620	29.5	539.88
NSYPLA1053TG	1000	x 500	x 320	27.3	515.57
NSYPLA1054TG	1000	x 500	x 420	29.45	506.62
NSYPLA1073TG	1000	x 750	x 320	28.38	611.48
NSYPLA1074TG	1000	x 750	x 420	36.49	637.16
NSYPLA1253TG	1250	x 500	x 320	28.7	541.79
NSYPLA1254TG	1250	x 500	x 420	34.9	551.50
NSYPLA1273TG	1250	x 750	x 320	35	646.00
NSYPLA1274TG	1250	x 750	x 420	38	698.45
NSYPLA1276TG	1250	x 750	x 620	63.2	742.89
NSYPLA1553TG	1500	x 500	x 320	30.7	595.74
NSYPLA1554TG	1500	x 500	x 420	39.5	626.52
NSYPLA1573TG	1500	x 750	x 320	41.5	721.30
NSYPLA1574TG	1500	x 750	x 420	53.9	745.22
NSYPLA1576TG	1500	x 750	x 620	67	829.49

## IP65 RAL7035

### Thalassa NSYPLATG Double Plain Glazed Door Solid Top & Bottom

REF NO	Dimensions (mm)			Weight kg	PRICE
	H	x W	x D		
NSYPLA5103TG	500	x 1000	x 320	27.3	578.65
NSYPLA5104TG	500	x 1000	x 420	27.45	600.45
NSYPLA5123TG	500	x 1250	x 320	30.68	709.90
NSYPLA5124TG	500	x 1250	x 420	37.45	719.81
NSYPLA7103TG	750	x 1000	x 320	28.38	649.25
NSYPLA7104TG	750	x 1000	x 420	36.49	662.77
NSYPLA7123TG	750	x 1250	x 320	33.79	814.58
NSYPLA7124TG	750	x 1250	x 420	43.44	820.35
NSYPLA10103TG	1000	x 1000	x 320	39.73	803.65
NSYPLA10104TG	1000	x 1000	x 420	51.08	869.98
NSYPLA10123TG	1000	x 1250	x 320	47.3	988.80
NSYPLA10124TG	1000	x 1250	x 420	60.8	1009.54
NSYPLA12103TG	1250	x 1000	x 320	51	899.52
NSYPLA12104TG	1250	x 1000	x 420	56	974.01
NSYPLA12123TG	1250	x 1250	x 320	58	1126.79
NSYPLA12124TG	1250	x 1250	x 420	62.5	1149.02
NSYPLA12126TG	1250	x 1250	x 620	76	1295.81
NSYPLA15103TG	1500	x 1000	x 320	58.6	1031.60
NSYPLA15104TG	1500	x 1000	x 420	75.4	1089.27
NSYPLA15123TG	1500	x 1250	x 320	70	1239.06
NSYPLA15124TG	1500	x 1250	x 420	78	1287.86
NSYPLA15126TG	1500	x 1250	x 620	97	1424.00
NSYPLA2074TG	2000	x 750	x 420	81	1136.85



## IMPORTANT INFORMATION

On double door enclosures there is a central post which forms part of the locking system. It can be temporarily removed when working on the enclosure but must be replaced. Please be aware of this if using the enclosure to house another enclosure as the central post may restrict the door opening of the enclosure inside.

**Mounting Plates for Thalassa NSYPLAG Enclosures Galvanised Steel**

REF NO	Dimensions (mm)			Weight kg	PRICE
	H	x	W		
NSYPMM55	390	x	375	2.5	21.99
NSYPMM510	390	x	875	6.3	55.17
NSYPMM75	640	x	375	3.8	34.99
NSYPMM77	640	x	625	7.8	52.41
NSYPMM710	640	x	875	10.6	69.33
NSYPMM712	640	x	1125	17.6	110.70
NSYPMM105	890	x	375	6.5	48.20
NSYPMM107	890	x	625	10.8	69.33
NSYPMM1010	890	x	875	15.0	95.24
NSYPMM1012	890	x	1125	19.3	120.00
NSYPMM125	1125	x	375	8.6	60.25
NSYPMM127	1125	x	625	14.2	89.44
NSYPMM1210	1125	x	875	19.4	120.00
NSYPMM1212	1125	x	1125	24.9	188.81
NSYPMM155	1375	x	375	10.6	82.08
NSYPMM157	1375	x	625	17.3	113.01
NSYPMM1510	1375	x	875	23.8	144.06
NSYPMM1512	1375	x	1125	30.5	206.00
NSYPMM207	1890	x	625	22.8	209.07

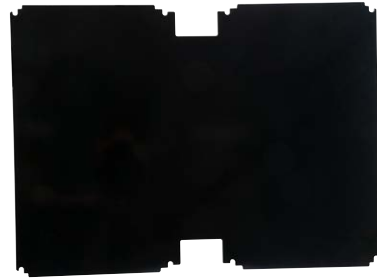

NSYPMB710

**Mounting Plates for Thalassa NSYPLAG Enclosures Bakelite**

REF NO	Dimensions (mm)			Weight Kg	PRICE
	H	x	W		
NSYPMB55	390	x	375	0.9	25.17
NSYPMB510	390	x	875	2.4	72.31
NSYPMB75	640	x	375	1.3	45.59
NSYPMB77	640	x	625	2.8	115.63
NSYPMB710	640	x	875	3.9	120.36
NSYPMB712	640	x	1125	5.0	120.53
NSYPMB105	890	x	375	2.3	99.63
NSYPMB107	890	x	625	3.9	121.08
NSYPMB1010	890	x	875	5.5	171.28
NSYPMB1012	890	x	1125	7.1	171.96
NSYPMB125	1125	x	375	3.0	67.81
NSYPMB127	1125	x	625	5.0	116.40
NSYPMB1210	1125	x	875	7.0	174.00
NSYPMB1212	1125	x	1125	9.0	174.79
NSYPMB155	1375	x	375	3.7	116.03
NSYPMB157	1375	x	625	6.1	246.38
NSYPMB1510	1375	x	875	8.6	252.27
NSYPMB1512	1375	x	1125	11.0	252.91



Double door enclosures will accept a single mounting plate or two separate mounting plates. There are two exceptions in that an NSYPMM55 and NSYPMM75 must both be used for NSYPLA5123G and NSYPLA5124G.



**Adjustable Mounting Plate Supports**

The adjustable supports allow the plate to be mounted at varying depth positions within the enclosure. One set of the NSYDPLA supports are required for single door enclosures. Two sets are required for double door enclosures.

REF NO	Description	PRICE
NSYDPLA3	Adjustable plate supports for enclosures 320mm deep.	57.21
NSYDPLA4	Adjustable plate supports for enclosures 420mm deep.	63.44
NSYDPLA6	Adjustable plate supports for enclosures 620mm deep.	98.65

**Enclosure Mounting Plate Combinations**

ENCLOSURES	Mounting Plates required if using 2 mounting plates
NSYPLA5103G & NSYPLA5104G	→ NSYPMM55 + NSYPMM55
NSYPLA5123G & NSYPLA5124G	→ NSYPMM55 + NSYPMM75
NSYPLA7103G & NSYPLA7104G	→ NSYPMM75 + NSYPMM75
NSYPLA7123G & NSYPLA7124G	→ NSYPMM75 + NSYPMM77
NSYPLA10103G & NSYPLA10104G	→ NSYPMM105 + NSYPMM105
NSYPLA10123G & NSYPLA10124G	→ NSYPMM105 + NSYPMM107
NSYPLA12103G & NSYPLA12104G	→ NSYPMM125 + NSYPMM125
NSYPLA12123G & NSYPLA12124G	→ NSYPMM125 + NSYPMM127
NSYPLA15103G & NSYPLA15104G	→ NSYPMM155 + NSYPMM155
NSYPLA15123G & NSYPLA15124G	→ NSYPMM155 + NSYPMM157



NSYEBMPLAG

NSYBCMPLAG

**Handle Lock & Lock Inserts for NSYPLAG Enclosures**

The standard lock supplied is an NSYEBMPLAG and is supplied with a double bar lock insert. This may be changed for a different lock insert if required.

REF NO	Description	PRICE
NSYEBMPLAG	Handle Lock for NSYPLAG Enclosure	22.03
NSYBCMPLAG	Handle Lock for NSYPLAG enclosures incorporating padlock facility	80.96
NSYBCPLA	Padlock Device	61.55
NSYIN405E1	Insert with key type 405	10.98
NSYINT71	Insert with 7mm Triangular Key	10.98
NSYINT81	Insert with 8mm Triangular Key	10.98
NSYINS71	Insert with 7mm Square Key	10.98
NSYINS81	Insert with 8mm Square Key	10.98

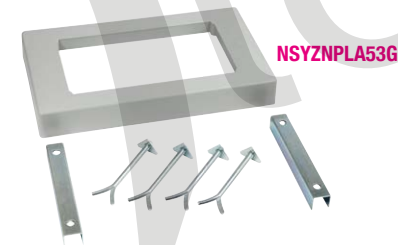

NSYZNPLA53G

**RAL7035**

**Bases for NSYPLAG Enclosures**

The NSYZNPLAG base allows the enclosure to be secured to the ground. At 60mm high it allows easy opening of the enclosure doors. The base is supplied with four fixing stakes which secure the enclosure to the base and the base to the ground.

REF NO	Dimensions (mm)				PRICE	
	W	x	D	x		H
NSYZNPLA53G	500	x	320	x	60	86.72
NSYZNPLA73G	750	x	320	x	60	92.44
NSYZNPLA103G	1000	x	320	x	60	104.14
NSYZNPLA123G	1250	x	320	x	60	102.65
NSYZNPLA54G	500	x	420	x	60	94.31
NSYZNPLA74G	750	x	420	x	60	100.64
NSYZNPLA104G	1000	x	420	x	60	106.90
NSYZNPLA124G	1250	x	420	x	60	113.32

**Accessories for NSYPLAG Enclosures**

REF NO	Description	PRICE
NSYRETPLAU	Door Retainer allowing door to be secured at either 90° or 120° (This part is incompatible with internal doors)	16.96
NSYFMPLA	Wall Fixing Brackets	16.42
NSYSNLPLA	Door Switch with NO + NC Contacts. Supplied with bracket and fixings	31.04



NSYFMPLA

NSYRETPLAU

NSYSNLPLA

**RAL7035**

**Internal Door for Thalassa NSYPLAG Enclosures**

REF NO	For Enclosure Size (mm)		Internal Door Dimensions (mm)		PRICE		
	H	x	W	H		x	W
NSYPAPLA55G	500	x	500	398	x	398	86.69
NSYPAPLA57G	500	x	750	398	x	648	99.97
NSYPAPLA75G	700	x	500	648	x	398	117.33
NSYPAPLA77G	750	x	750	648	x	648	151.77
NSYPAPLA105G	1000	x	500	898	x	398	122.06
NSYPAPLA107G	1000	x	750	898	x	648	160.81
NSYPAPLA125G	1250	x	500	1148	x	398	139.46
NSYPAPLA127G	1250	x	750	1148	x	648	223.41
NSYPAPLA155G	1500	x	500	1398	x	398	158.59
NSYPAPLA157G	1500	x	750	1398	x	648	255.09

**Enclosure Internal Door Combinations**

ENCLOSURES	Combination of Internal Doors Required
NSYPLA5103G & NSYPLA5104G	→ NSYPAPLA55G x 2
NSYPLA5123G & NSYPLA5124G	→ NSYPAPLA55G + NSYPAPLA57G
NSYPLA7103G & NSYPLA7104G	→ NSYPAPLA75G x 2
NSYPLA7123G & NSYPLA7124G	→ NSYPAPLA75G + NSYPAPLA77G
NSYPLA10103G & NSYPLA10104G	→ NSYPAPLA105G x 2
NSYPLA10123G & NSYPLA10124G	→ NSYPAPLA105G + NSYPAPLA107G
NSYPLA12103G & NSYPLA12104G	→ NSYPAPLA125G x 2
NSYPLA12123G & NSYPLA12124G	→ NSYPAPLA125G + NSYPAPLA127G
NSYPLA15103G & NSYPLA15104G	→ NSYPAPLA155G x 2
NSYPLA15123G & NSYPLA15124G	→ NSYPAPLA155G + NSYPAPLA157G



NSYTJPLA\*\*G

**RAL7035**  
Canopies for NSYPLAG Enclosures

REF NO	Dimensions (mm)			PRICE
	W	x D	x H	
NSYTJPLA53G	500	x 320	x 38	26.05
NSYTJPLA73G	750	x 320	x 38	33.55
NSYTJPLA103G	1000	x 320	x 38	39.76
NSYTJPLA123G	1250	x 320	x 38	47.12
NSYTJPLA54G	500	x 420	x 38	29.39
NSYTJPLA74G	750	x 420	x 38	35.43
NSYTJPLA104G	1000	x 420	x 38	46.71
NSYTJPLA124G	1250	x 420	x 38	50.44
NSYTJPLA76G	750	x 620	x 38	44.99
NSYTJPLA126G	1250	x 620	x 38	71.91

**RAL7035**  
Coupling Kits - Vertical

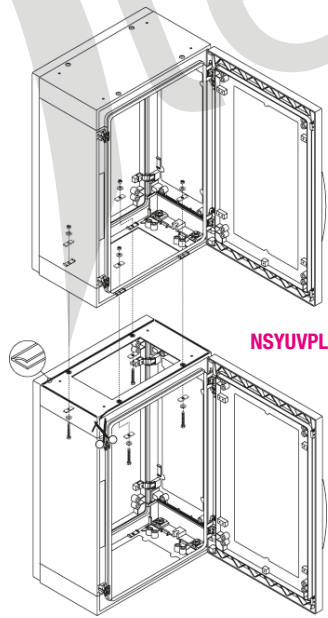

NSYUPLA

REF NO	Description	PRICE
NSYUPLA	To mount enclosures one on top of another. Kit comprises of lugs, 3.5 Metres of adhesive seal and all necessary hardware.	17.59

**RAL7035**  
Coupling Kits - Horizontal

REF NO	Description	PRICE
<b>To join enclosures along side each other:</b>		
NSYMUPLA53G	500mm high x 320mm deep	37.12
NSYMUPLA73G	750mm high x 320mm deep	38.72
NSYMUPLA103G	1000mm high x 320mm deep	39.82
NSYMUPLA123G	1250mm high x 320mm deep	43.74
NSYMUPLA153G	1500mm high x 320mm deep	49.32
NSYMUPLA54G	500mm high x 420mm deep	30.79
NSYMUPLA74G	750mm high x 420mm deep	30.16
NSYMUPLA104G	1000mm high x 420mm deep	52.57
NSYMUPLA124G	1250mm high x 420mm deep	44.81
NSYMUPLA154G	1500mm high x 420mm deep	51.08
NSYMUPLA204G	2000mm high x 420mm deep	64.58
NSYMUPLA76G	750mm high x 620mm deep	31.75
NSYMUPLA126G	1250mm high x 620mm deep	60.17
NSYMUPLA156G	1500mm high x 620mm deep	61.61

**RAL7035**  
Coupling Kits - Horizontal Filler Pieces

REF NO	Description	PRICE
NSYSUPLA3G	Filler pieces to be used in conjunction with NSYMUPLA kits 320mm deep	36.88
NSYSUPLA4G	Filler pieces to be used in conjunction with NSYMUPLA kits 420mm deep	39.46
NSYSUPLA3TG	Filler pieces to be used in conjunction with NSYMUPLA kits for enclosures with canopies 320mm deep	40.09
NSYSUPLA4TG	Filler pieces to be used in conjunction with NSYMUPLA kits for enclosures with canopies 420mm deep	44.18

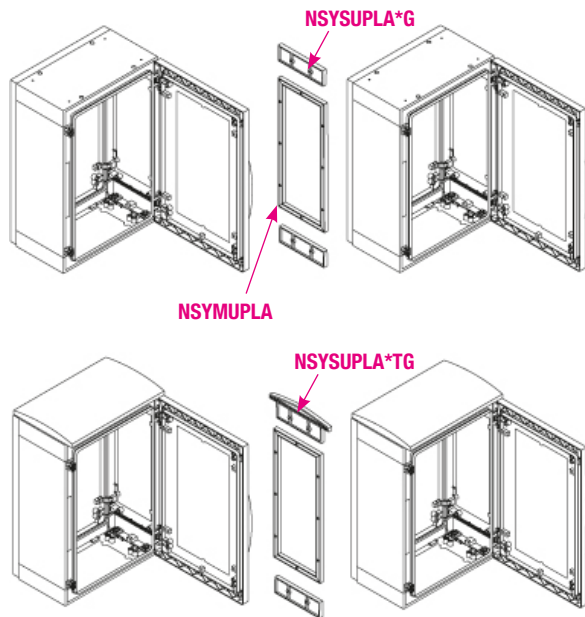

NSYSUPLA\*G

NSYMUPLA

NSYSUPLA\*TG



EMB-RG

**Domestic Electricity Meter Housings**

Domestic electric meter housings are available in both recessed and surface mounting versions. Both enclosures have a variety of cable insert positions. These universal enclosures can be used anywhere in the UK.

Baseboard Fitted  
Colour: White

REF NO	Dimensions (mm)			PRICE
	H	x W	x D	
<b>Recessed</b>				
EMB-RG	600	x 430	x 220	23.00
<b>Surface mounted</b>				
EMB-SG	560	x 400	x 215	39.00
EMB-KEY	Spare Key For Electric Meter Boxes			2.35
EMB-HSW	Hockey Stick 1700 x 38mm			5.72



EMB-SG



EMB-KEY

Used primarily to house electrical equipment, the IC range, or 'roadside kiosks' are rated at IP54.

Available in British Racing Green 14C39, models are supplied with a plywood backboard and cylinder rim lock as standard.

GRP kiosks have many advantages over traditional brick-built and steel enclosures.

iLECSYS also have a range of domestic electric meter boxes. These enclosures are suitable for all domestic meters and highly weather resistant. The range includes a recessed and surface mounted model. A brown version is also available on request.



RSC1274GN

**IP54 14C39**  
GRP Roadside / Electricity Meter Housings - IP54

The IC range of enclosures come with the following features as standard:

- External colour 14C39 Green
- Cylinder rim lock
- Plywood backboard
- Stainless steel hinges
- Solid GRP base
- Narrow Door Pillars

Optional Extras include alternative external colour, ventilation, cable access flap, 100mm base flange and optional window.

REF NO	Dimensions (mm)			No of Doors	PRICE
	H	x W	x D		
RSC1274GN	1250	x 750	x 450	1	POA
RSC1795GN	1750	x 900	x 550	1	POA
RSC12124GN	1250	x 1250	x 450	2	POA
RSC17205GN	1750	x 2000	x 550	2	POA

The Minipol wall-mounted enclosures are moulded in one piece from glass reinforced polyester. Suitable for a wide range of applications including harsh environments, both indoor and outdoor.

IP66 according to IEC 60529, IK10 according to IEC 62262, IK08 according to IEC 62262 (glazed window).

**NEW!**



MN321

**IP66 RAL7035**

Minipol Wall Mounted Enclosure with Plain Door

REF NO	Dimensions (mm)			No. of locks	PRICE
	H	W	D		
MN321 (MIP-325)	300	250	140	1	58.77
MN432 (MIP-432)	400	300	200	2	76.94
MN442 (MIP-442)	400	400	200	2	89.77
MN542 (MIP-542)	500	400	200	2	108.35
MN642 (MIP-642)	600	400	230	2	125.66
MN652 (MIP-652)	600	500	230	2	142.86
MN683 (MIP-683)	600	800	300	2	272.23
MN863 (MIP-863)	800	600	300	2	280.71



MN863-V

**IP66 RAL7035**

Minipol Wall Mounted Enclosure with Transparent Door

REF NO	Dimensions (mm)			No. of Locks	PRICE
	H	W	D		
MN321-V (MIP-325PT)	300	250	140	1	81.43
MN432-V (MIP-432PT)	400	300	200	2	125.66
MN442-V (MIP-442PT)	400	400	200	2	139.91
MN542-V (MIP-542PT)	500	400	200	2	164.23
MN642-V (MIP-642PT)	600	400	230	2	170.82
MN652-V (MIP-652PT)	600	500	230	2	230.51
MN683-V (MIP-683PT)	600	800	300	2	397.29
MN863-V (MIP-863PT)	800	600	300	2	347.66



**RAL7035**

Minipol Internal Doors - Polyester

REF NO	Description	PRICE
MN-PI43	MN 432 / MN 432V	64.37
MN-PI44	MN 442 / MN 442V	70.49
MN-PI54	MN 542 / MN 542V	80.34
MN-PI64	MN 642 / MN 542V	99.37
MN-PI65	MN 652 / MN 652V	76.51
MN-PI86	MN 863 / MN 863V	112.74



MN-PM44

MN-PM32

Mounting Plates for Minipol Enclosures  
Galvanised Steel

REF NO	Plate Size (mm)	Enclosure Size (mm)	PRICE
MN-PM32	268 x 213	300 x 250	9.17
MN-PM43	358 x 260	400 x 300	10.69
MN-PM44	358 x 360	400 x 400	16.63
MN-PM54	458 x 360	500 x 400	17.09
MN-PM64	558 x 360	600 x 400	24.63
MN-PM65	558 x 360	600 x 500	24.51
MN-PM86-68	754 x 556	600 x 800	44.69
MN-P86-68	754 x 556	600 x 800	53.26



MN-P44

MN-P32

Mounting Plates for Minipol Enclosures  
Polyester

REF NO	Plate Size (mm)	Enclosure Size (mm)	PRICE
MN-P32	268 x 213	300 x 250	8.00
MN-P43	358 x 260	400 x 300	10.11
MN-P44	358 x 360	400 x 400	15.54
MN-P54	458 x 360	500 x 400	24.49
MN-P64	558 x 360	600 x 400	25.14
MN-P65	558 x 460	600 x 500	29.57
MN-P86-68	754 x 556	600 x 800	53.26



MNFP-300

Pole Mounting Kit (strap not included)

REF NO	Description	PRICE
MNFP-250	For 250 wide enclosures	13.06
MNFP-300	For 300 wide enclosures	16.37
MNFP-400	For 400 wide enclosures	18.00
MNFP-500	For 500 wide enclosures	19.80
MNFP-600	For 600 wide enclosures	28.09



DVG



2-701-7047BJ



MN-SFM



CLLMN

Minipol Accessories

REF NO	Description	PRICE
MN-SFM	Pk/4 Wall mounting kit (POF)	5.71
2-701-7047BJ	Universal enclosure key	1.99
CTMN	Triangular lock with key	11.54
CDBMN	Double bar lock with key (PBD)	8.17
CLLMN	Key lock with key (PCM)	9.40
CBMNM	Padlock Hasp	6.53
DVG (Pair)	Ventilation Devices x 2 RAL7035, IP44	4.35

Control Units

Schneider Electric

Pages 264-277

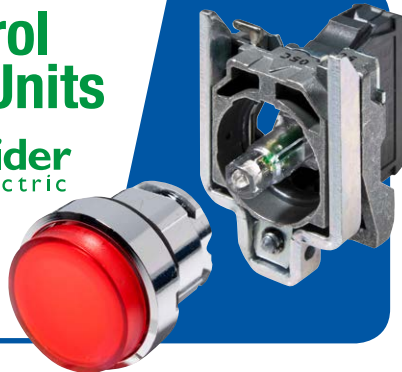

The Cahors Combiester range is ideal for outdoor use. The enclosures consist of a polyester base and a choice of polycarbonate or polyester lids. Rated to IP66 and supplied in RAL7035.

Combiester enclosures can be used in either orientation and can be joined horizontally and vertically using coupling frames.



**IP66 RAL7035**  
Combiester Polyester Enclosures  
Grey Polycarbonate Lid

REF NO	Dimensions (mm)				PRICE	
	H	x	W	x		D
MHO15	135	x	135	x	129	14.40
MHO21	180	x	135	x	129	17.71
MHO22	180	x	180	x	129	20.85
MHO31	270	x	135	x	129	20.93
MHO32	270	x	180	x	171	35.92
MHO32B	270	x	180	x	141	22.93
MHO33	270	x	270	x	171	44.64
MHO34	270	x	360	x	171	47.39
MHO34A	270	x	360	x	201	60.08
MHO42	360	x	180	x	171	70.56
MHO44	360	x	360	x	171	74.27
MHO44A	360	x	360	x	201	85.28
MHO63	540	x	270	x	171	85.57
MHO63A	540	x	270	x	201	114.11
MHO64	540	x	360	x	171	87.92
MHO64A	540	x	360	x	201	136.32
MHO66	540	x	540	x	171	177.52
MHO66A	540	x	540	x	201	196.75
MHO84A	720	x	360	x	201	209.52
MHO86A	720	x	540	x	201	246.69

**IP65 RAL7035**  
Combiester Polyester Enclosures  
Transparent Polycarbonate Lid

REF NO	Dimensions (mm)				PRICE	
	H	x	W	x		D
MH15	135	x	135	x	129	15.89
MH21	180	x	135	x	129	17.87
MH22	180	x	180	x	129	21.92
MH31	270	x	135	x	129	22.35
MH32B	270	x	180	x	141	41.63
MH32	270	x	180	x	171	37.09
MH33	270	x	270	x	171	43.81
MH34	270	x	360	x	171	56.35
MH34A	270	x	360	x	201	60.29
MH42	360	x	180	x	171	68.43
MH44	360	x	360	x	171	74.75
MH44A	360	x	360	x	201	85.28
MH63	540	x	270	x	171	58.37
MH63A	540	x	270	x	201	114.11
MH64	540	x	360	x	171	101.33
MH64A	540	x	360	x	201	114.64
MH66	540	x	540	x	171	149.36
MH66A	540	x	540	x	201	158.27
MH84A	720	x	360	x	201	175.95
MH86A	720	x	540	x	201	205.25



**IP65 RAL7035**  
Combiester Polyester Enclosures  
Grey Polyester Lid

REF NO	Dimensions (mm)				PRICE	
	H	x	W	x		D
MHP32	270	x	180	x	171	37.87
MHP33	270	x	270	x	171	46.35
MHP34	270	x	360	x	171	43.09
MHP63	540	x	270	x	171	73.79



**IP65 RAL7035**  
Combiester Enclosures Glazed Hinged Door

REF NO	Dimensions (mm)			PRICE		
	H	x	W		x	D
MH33PAT	270	x	270	x	171	46.48
MH34PAT	360	x	270	x	171	51.76

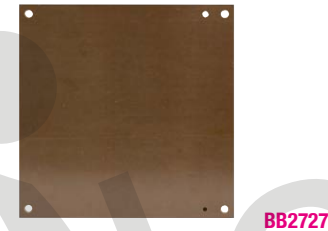

**Bakelite Mounting Plates**

REF NO	Plate Size (mm)		Enclosures Size (mm)		PRICE		
	H	x	H	x		W	
BB1313	97	x	97	135	x	135	4.94
BB1813	142	x	97	180	x	135	6.31
BB1818	142	x	142	180	x	180	10.51
BB2713	234	x	99	270	x	135	8.77
BB2718	220	x	134	270	x	180	8.83
BB2727	220	x	220	270	x	270	12.43
BB2736	220	x	310	270	x	360	15.97
BB3618	310	x	130	360	x	180	11.00
BB3636	310	x	310	360	x	360	23.77
BB5427	490	x	220	540	x	270	31.77
BB5436	490	x	310	540	x	360	35.66
BB5454	490	x	490	540	x	540	42.14
BB7236	670	x	310	720	x	360	58.26
BB7254	670	x	490	720	x	540	63.34

**Coupling Frame**

REF NO	Description	PRICE
CA135	For 135mm side	8.11
CA180	For 180mm side	8.37
CA270	For 270mm side	9.43
CA360	For 360mm side	11.00



**Metal Mounting Plates**

REF NO	Plate Size (mm)		Enclosures Size (mm)		PRICE		
	H	x	H	x		W	
BM1313	97	x	97	135	x	135	2.34
BM1813	142	x	97	180	x	135	3.06
BM1818	142	x	142	180	x	180	3.40
BM2713	234	x	99	270	x	135	3.66
BM2718	220	x	134	270	x	180	4.06
BM2727	220	x	220	270	x	270	5.00
BM2736	220	x	310	270	x	360	7.11
BM3618	310	x	130	360	x	180	7.71
BM3636	310	x	310	360	x	360	11.17
BM5427	490	x	220	540	x	270	12.00
BM5436	490	x	310	540	x	360	16.06
BM5454	490	x	490	540	x	540	24.83
BM7236	670	x	310	720	x	360	22.49
BM7254	670	x	490	720	x	540	35.54

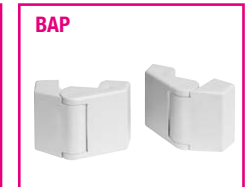

**Combiester Enclosure Accessories**

REF NO	Dimensions (mm)	PRICE
CB18	External mounting brackets	3.03
SETKEY	Key lock with key	19.20
BAM	Internal hinges	6.03
BAP	External hinges	5.92
TCD33G	Set of 4 corner screws	3.17
DEVA	Drainage valve	4.29

A range of double insulated boxes with the base made from glass fibre reinforced polyester and the lids from high strength polycarbonate or polyester, in opaque grey or transparent. NSYPLSG boxes have a modular design which also permits the joining of boxes to form assemblies.

Resistant to corrosion, ultraviolet light, chemicals and a wide operating temperature range of -30°C to +120°C. Protection rating of IP65.

**IP65 RAL7035**

**NSYPLSG - Low Transparent Polycarbonate Lid**

REF NO	Dimensions (mm)			Weight kg	PRICE
	H	x	W x D		
NSYPLS1827G	270	x	180 x 180	1.24	35.61
NSYPLS2727G	270	x	270 x 180	1.85	43.46
NSYPLS2736G	360	x	270 x 180	2.13	53.25
NSYPLS2754G	540	x	270 x 180	2.93	73.84
NSYPLS3636G	360	x	360 x 180	2.5	70.96
NSYPLS3654G	540	x	360 x 180	4.1	92.48
NSYPLS5454G	540	x	540 x 180	5.75	137.01



NSYPLS1827G

NSYPLS2736G

**IP65 RAL7035**

**NSYPLS-AG High Transparent Polycarbonate Lid**

REF NO	Dimensions (mm)			Weight kg	PRICE
	H	x	W x D		
NSYPLS2727AG	270	x	270 x 230	1.93	57.18
NSYPLS2736AG	360	x	270 x 230	2.21	61.99
NSYPLS2754AG	540	x	270 x 230	3.18	94.99
NSYPLS3672AG	360	x	720 x 230	5.65	144.92
NSYPLS3654AG	540	x	360 x 230	4.15	108.60
NSYPLS5454AG	540	x	540 x 230	6.2	147.57
NSYPLS5472AG	540	x	720 x 230	8	207.51

**IP65 RAL7035**

**NSYPLSCG - Low Grey Polycarbonate Lid**

REF NO	Dimensions (mm)			Weight kg	PRICE
	H	x	W x D		
NSYPLSC1827G	270	x	180 x 180	1.24	40.52
NSYPLSC2727G	270	x	270 x 180	1.85	49.98
NSYPLSC2736G	360	x	270 x 180	2.14	56.05
NSYPLSC2754G	540	x	270 x 180	2.93	87.81
NSYPLSC3636G	360	x	360 x 180	3	74.46
NSYPLSC3654G	540	x	360 x 180	4.09	104.67
NSYPLSC5454G	540	x	540 x 180	5.8	151.09



NSYPLSC2736G

**IP65 RAL7035**

**NSYPLSC-AG High Grey Polycarbonate Lid**

REF NO	Dimensions (mm)			Weight kg	PRICE
	H	x	W x D		
NSYPLSC2727AG	270	x	270 x 230	1.93	57.59
NSYPLSC2736AG	360	x	270 x 230	2.21	70.28
NSYPLSC2754AG	540	x	270 x 230	3.18	94.74
NSYPLSC3672AG	360	x	720 x 230	5.65	158.52
NSYPLSC3654AG	540	x	360 x 230	4.15	117.18
NSYPLSC5454AG	540	x	540 x 230	6.2	163.84
NSYPLSC5472AG	540	x	720 x 230	8	230.96



NSYPLSC3654AG

**IP65 RAL7035**

**NSYPLSPG - Low Grey Polyester Lid**

The NSYPLSPG enclosure has a Polyester Base & Lid. Polyester has a greater resistance to oils and chemicals and is therefore more suitable to a harsher environment.

REF NO	Dimensions (mm)			Weight kg	PRICE
	H	x	W x D		
NSYPLSP1827G	270	x	180 x 180	1.76	38.75
NSYPLSP2727G	270	x	270 x 180	2.5	45.00
NSYPLSP2736G	360	x	270 x 180	2.82	55.86
NSYPLSP2754G	540	x	270 x 180	3.74	78.87
NSYPLSP3636G	360	x	360 x 180	3	85.94
NSYPLSP3654G	540	x	360 x 180	4.85	103.48
NSYPLSP5454G	540	x	540 x 180	5.75	155.65



NSYPLSP2736G

**Mounting Plates for NSYPLSG Boxes**

REF NO	For Enclosure Size (mm)		Actual Plate Size (mm)		PRICE
	H	x	W	H x W	
NSYPM1827	180	x	270	140 x 230	5.89
NSYPM2727	270	x	270	230 x 230	9.41
NSYPM2736	270	x	360	230 x 320	11.59
NSYPM2754	270	x	540	230 x 500	17.10
NSYPM3636	360	x	360	320 x 320	16.46
NSYPM3654	360	x	540	320 x 500	21.49
NSYPM3672	360	x	720	320 x 680	30.99
NSYPM5454	540	x	540	500 x 500	34.62
NSYPM5472	540	x	720	500 x 680	45.52



NSYPM1827



NSYBE27G

NSYCAG33LP

**NSYPLSG System 27 Accessories**

REF NO	Description	PRICE
NSYPF27N	Set of 4 wall fixing brackets	4.83
NSYBE27G	Pair of external hinges	11.99
NSYCAG19LP	19mm (cut out size) air vent	2.34/PK2
NSYCAG33LP	33mm (cut out size) air vent	15.50/PK2
NSYUM27180	Coupling Frame for 180mm Side Opening 77 x 110mm	12.53
NSYUM27270	Coupling Frame for 270mm Side Opening 77 x 200mm	13.26
NSYUM27360	Coupling Frame for 360mm Side Opening 77 x 290mm	20.76
NSYTL27270G	Gland Plate 77 x 200mm	22.52
NSYTL27360G	Gland Plate 77 x 290mm	23.29

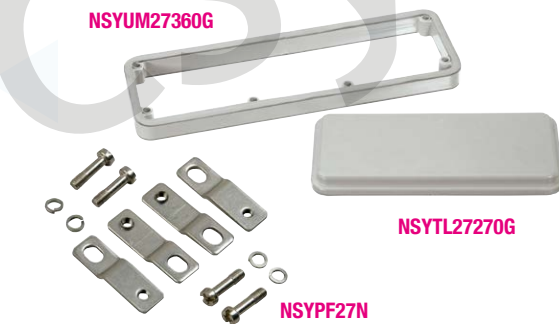

NSYUM27360G

NSYTL27270G

NSYPF27N

**DIN Rail cut to size**

**Short on time?**  
We can cut custom size DIN Rail to suit your exact requirement.

See page 147 for our range and call us for more information



The Spacial NSYSM floor standing enclosure is rated at IP55 and made from sheet steel, welded rear panel and the front forming a rigid frame with welded corners.

The doors are made from folded and welded steel with 120° opening. A swing handle is supplied as standard with a 5mm double bar insert. A glazed door option is also available.

**Certifications - BV, DNV, UL and CUL**  
**Single Door : 1, 2, 3, 3R, 4, 5, 12, 12K and 13**  
**Double Door: 1, 12, 12K**

## IP55 RAL7035

### NSYSM Floor Standing Enclosures with Mounting Plate

REF NO	Dimensions (mm) H x W x D	No. of Doors	PRICE
<b>1200mm High</b>			
NSYSM12830P	1200 x 800 x 300	1	474.57
NSYSM1210302DP	1200 x 1000 x 300	2	524.18
NSYSM1212402DP	1200 x 1200 x 400	2	569.48
<b>1400mm High</b>			
NSYSM14630P	1400 x 600 x 300	1	415.72
NSYSM14640P	1400 x 600 x 400	1	439.10
NSYSM14830P	1400 x 800 x 300	1	437.68
NSYSM14840P	1400 x 800 x 400	1	465.62
NSYSM1410402DP	1400 x 1000 x 400	2	569.03
NSYSM1412402DP	1400 x 1200 x 400	2	701.00
<b>1600mm High</b>			
NSYSM16630P	1600 x 600 x 300	1	426.13
NSYSM16640P	1600 x 600 x 400	1	434.10
NSYSM16830P	1600 x 800 x 300	1	490.02
NSYSM16840P	1600 x 800 x 400	1	489.39
NSYSM1610302DP	1600 x 1000 x 300	2	606.11
NSYSM1610402DP	1600 x 1000 x 400	2	619.23
NSYSM1612302DP	1600 x 1200 x 300	2	683.40
NSYSM1612402DP	1600 x 1200 x 400	2	587.87



NSYSM18840P

## IP55 RAL7035

### NSYSM Floor Standing Enclosures with Mounting Plate

REF NO	Dimensions (mm) H x W x D	No. of Doors	PRICE
<b>1800mm High</b>			
NSYSM18630P	1800 x 600 x 300	1	436.33
NSYSM18640P	1800 x 600 x 400	1	444.39
NSYSM18650P	1800 x 600 x 500	1	504.85
NSYSM18830P	1800 x 800 x 300	1	476.43
NSYSM18840P	1800 x 800 x 400	1	478.36
NSYSM18850P	1800 x 800 x 500	1	542.00
NSYSM18860P	1800 x 800 x 600	1	610.97
NSYSM181040P	1800 x 1000 x 400	1	584.72
NSYSM1810402DP	1800 x 1000 x 400	2	614.01
NSYSM1810502DP	1800 x 1000 x 500	2	671.93
NSYSM1812402DP	1800 x 1200 x 400	2	649.66
NSYSM1812502DP	1800 x 1200 x 500	2	809.08
NSYSM1816402DP	1800 x 1600 x 400	2	837.04
NSYSM1816502DP	1800 x 1600 x 500	2	946.83
<b>2000mm High</b>			
NSYSM20630P	2000 x 600 x 300	1	539.33
NSYSM20640P	2000 x 600 x 400	1	549.42
NSYSM20650P	2000 x 600 x 500	1	601.83
NSYSM20830P	2000 x 800 x 300	1	590.09
NSYSM20840P	2000 x 800 x 400	1	627.32
NSYSM20850P	2000 x 800 x 500	1	669.69
NSYSM20860P	2000 x 800 x 600	1	718.50
NSYSM2010402DP	2000 x 1000 x 400	2	726.33
NSYSM2010502DP	2000 x 1000 x 500	2	777.20
NSYSM2012402DP	2000 x 1200 x 400	2	813.32
NSYSM2012502DP	2000 x 1200 x 500	2	895.72
NSYSM2012602DP	2000 x 1200 x 600	2	940.40
NSYSM2016402DP	2000 x 1600 x 400	2	1031.37
NSYSM2016502DP	2000 x 1600 x 500	2	1130.99
NSYSM2016602DP	2000 x 1600 x 600	2	1187.54



NSYSM1412402DP

## Front / Rear Plinth Sections for NSYSM Enclosures

The plinths for the NSYSM range are supplied in two parts and need to be ordered separately. The front/rear sections comprise four corner pieces with removable covers. They are available in 100mm or 200mm heights in dark grey to RAL7022.

REF NO	Description	PRICE
NSYSPPF6100	100mm High x 600mm Wide	35.82
NSYSPPF8100	100mm High x 800mm Wide	37.71
NSYSPPF10100	100mm High x 1000mm Wide	46.78
NSYSPPF12100	100mm High x 1200mm Wide	58.54
NSYSPPF16100	100mm High x 1600mm Wide	67.21
NSYSPPF6200	200mm High x 600mm Wide	64.47
NSYSPPF8200	200mm High x 800mm Wide	67.87
NSYSPPF10200	200mm High x 1000mm Wide	84.17
NSYSPPF12200	200mm High x 1200mm Wide	105.37
NSYSPPF16200	200mm High x 1600mm Wide	120.99

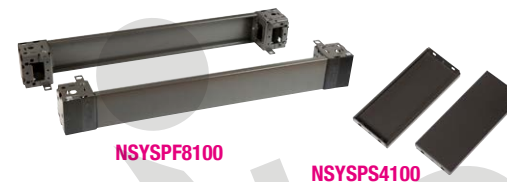

NSYSPPF8100

NSYSPPF4100

## Side Plinth Sections for NSYSM Enclosures

REF NO	Description	PRICE
NSYSPPS3100	100mm High x 300mm Deep	10.65
NSYSPPS4100	100mm High x 400mm Deep	10.23
NSYSPPS5100	100mm High x 500mm Deep	11.36
NSYSPPS6100	100mm High x 600mm Deep	12.41
NSYSPPS3200	200mm High x 400mm Deep	12.58
NSYSPPS4200	200mm High x 400mm Deep	14.55
NSYSPPS5200	200mm High x 500mm Deep	16.88
NSYSPPS6200	200mm High x 600mm Deep	18.93



NSYDPA5

NSYDPA4

## Self Adhesive Document Pockets

REF NO	Description	PRICE
NSYDPA5	Document Pocket for A5 Documents	6.02
NSYDPA4	22mm Deep Document Pocket for A4 Documents	7.38
NSYDPA44	40mm Deep Document Pocket for A4 Documents	7.14
NSYDPA3	Document Pocket for A3 Documents	17.27



ACRYLIC WINDOW

NSYCW54

## IP55

### Control Window

These control windows are an aluminum frame and 3mm acrylic window and features a keylock

REF NO	Dimensions (mm) H x W x D	PRICE
NSYCW33	300 x 300 x 77	259.19
NSYCW44	400 x 400 x 77	287.99
NSYCW45	400 x 500 x 77	316.79
NSYCW46	400 x 600 x 77	345.59
NSYCW54	500 x 400 x 77	302.39
NSYCW55	500 x 500 x 77	333.67
NSYCW56	500 x 600 x 77	362.87
NSYCW65	600 x 500 x 77	349.26
NSYCW66	600 x 600 x 77	384.18
NSYCW86	800 x 600 x 77	422.60



NSYIN405E1

## Lock Barrels and Shaped Inserts

The 5mm double bit lock supplied as standard in the enclosures can be replaced by one of the inserts listed below.

REF NO	Description	PRICE
NSYIN405E1	405E Key Lock Insert	10.98
NSYIN1242E1	1242E Key Lock Insert	10.98
NSYINS71	7mm Square Insert	10.98
NSYINS81	8mm Square Insert	10.98
NSYINT71	7mm Triangular Insert	10.98
NSYINT81	8mm Triangular Insert	10.98
NSYINPULS1	Push Button	10.98

The Spacial NSYSF floor standing enclosure is rated at IP55 and made from sheet steel. Vertical uprights are joined together with top and bottom frames. Can be supplied flat packed if required.

The enclosures are supplied as standard with a rear panel, a mounting plate, a plain or glazed door and roof. Side panels and cable entry glands plates are ordered separately.

The doors are made from folded and welded steel with 120° opening. A swing handle is supplied as standard with a 5mm double bar insert.

**Certifications - BV, DNV, UL and CUL**  
**Single Door : 1, 2, 3, 3R, 4, 5, 12, 12K and 13**  
**Double Door: 1, 12, 12K**

**IP55 RAL7035**  
**Spacial NSYSF with Mounting Plate 1800mm High**

REF NO	Dimensions (mm) H x W x D	No. of Doors	PRICE
NSYSF18650P	1800 x 600 x 500	1	501.74
NSYSF18850P	1800 x 800 x 500	1	528.16
NSYSF181050P	1800 x 1000 x 500	1	660.18
NSYSF1812502DP	1800 x 1200 x 500	2	792.19
NSY2SP185	Pair of side panels - 1800mm x 500mm		116.19
NSYPPS185	Partition panel for separating 2 bayed enclosures - 1800mmH x 500mmD		69.53
NSYSF18660P	1800 x 600 x 600	1	511.99
NSYSF18860P	1800 x 800 x 600	1	538.94
NSYSF181060P	1800 x 1000 x 600	1	673.66
NSYSF1810602DP	1800 x 1000 x 600	2	754.47
NSYSF1812602DP	1800 x 1200 x 600	2	808.39
NSY2SP186	Pair of side panels - 1800mm x 600mm		118.56
NSYPPS186	Partition panel for separating 2 bayed enclosures - 1800mmH x 600mmD		76.34



NSYSF18840P

**IP55 RAL7035**  
**Spacial NSYSF with Mounting Plate 1800mm High**

REF NO	Dimensions (mm) H x W x D	No. of Doors	PRICE
NSYSF18640P	1800 x 600 x 400	1	491.50
NSYSF18840P	1800 x 800 x 400	1	517.38
NSYSF181040P	1800 x 1000 x 400	1	646.71
NSYSF1810402DP	1800 x 1000 x 400	2	724.29
NSYSF1812402DP	1800 x 1200 x 400	2	776.07
NSY2SP184	Pair of side panels - 1800mm x 400mm		113.82
NSYPPS184	Partition panel for separating 2 bayed enclosures - 1800mmH x 400mmD		57.59

The NSYSF range of enclosures is also available in 1200, 1400 & 1600mm height variants.

Glazed version is supplied without mounting plate, please contact us for further details.

**Bottom Cable Entry Plates**

The Spacial NSYSF enclosures are supplied without a cable entry plate which should be ordered separately.

REF NO	Description	PRICE
NSYEC641	600W x 400D Cable Entry Plate - 1 Entry	21.35
NSYEC841	800W x 400D Cable Entry Plate - 1 Entry	23.18
NSYEC1041	1000W x 400D Cable Entry Plate - 1 Entry	32.78
NSYEC1241	1200W x 400D Cable Entry Plate - 1 Entry	39.91
NSYEC1641	1600W x 400D Cable Entry Plate - 1 Entry	48.75
NSYEC651	600W x 500D Cable Entry Plate - 1 Entry	21.23
NSYEC851	800W x 500D Cable Entry Plate - 1 Entry	26.17
NSYEC1051	1000W x 500D Cable Entry Plate - 1 Entry	33.11
NSYEC1251	1200W x 500D Cable Entry Plate - 1 Entry	44.18
NSYEC1651	1600W x 500D Cable Entry Plate - 1 Entry	52.43
NSYEC661	600W x 600D Cable Entry Plate - 1 Entry	22.33
NSYEC662	600W x 600D Cable Entry Plate - 2 Entries	28.99
NSYEC861	800W x 600D Cable Entry Plate - 1 Entry	29.38
NSYEC862	800W x 600D Cable Entry Plate - 2 Entries	35.56
NSYEC1061	1000W x 600D Cable Entry Plate - 1 Entry	34.87
NSYEC1062	1000W x 600D Cable Entry Plate - 2 Entries	38.70
NSYEC1261	1200W x 600D Cable Entry Plate - 1 Entry	54.42
NSYEC1262	1200W x 600D Cable Entry Plate - 2 Entries	58.56

**Front / Rear Plinth Sections for NSYSF Enclosures**

The NSYSF plinths are supplied in two parts and need to be ordered separately. The front/rear sections comprise four corner pieces with removable covers. They are available in 100mm or 200mm heights in dark grey to RAL7022.

REF NO	Description	PRICE
NSYSFP6100	100mm High x 600mm Wide	35.82
NSYSFP8100	100mm High x 800mm Wide	37.71
NSYSFP10100	100mm High x 1000mm Wide	46.78
NSYSFP12100	100mm High x 1200mm Wide	58.54
NSYSFP16100	100mm High x 1600mm Wide	67.21
NSYSFP6200	200mm High x 600mm Wide	64.47
NSYSFP8200	200mm High x 800mm Wide	67.87
NSYSFP10200	200mm High x 1000mm Wide	84.17
NSYSFP12200	200mm High x 1200mm Wide	105.37
NSYSFP16200	200mm High x 1600mm Wide	120.99

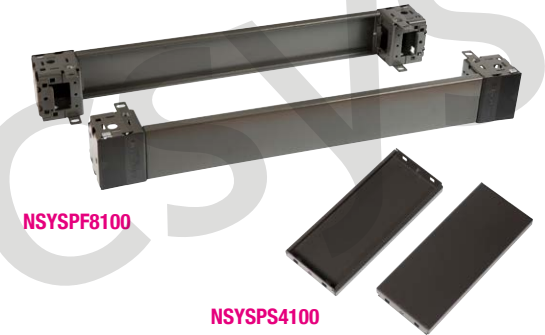

NSYSFP8100

NSYSFP16100

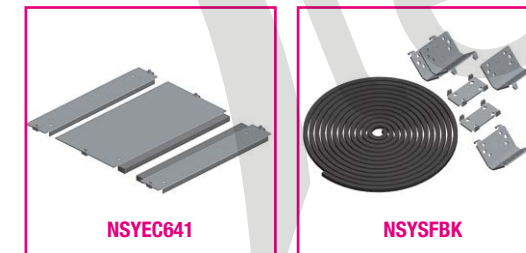

NSYEC641

NSYSFBK

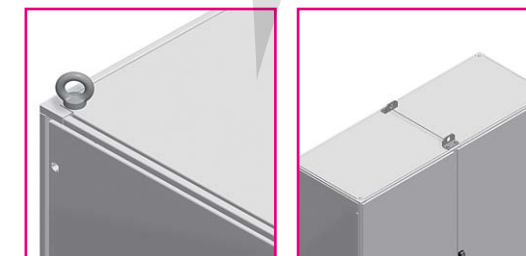

NSYSFEB

NSYSFELB



NSYIN1242E1

**Side Plinth Sections for NSYSF Enclosures**

REF NO	Description	PRICE
NSYSPS4100	100mm High x 400mm Deep	10.23
NSYSPS5100	100mm High x 500mm Deep	11.36
NSYSPS6100	100mm High x 600mm Deep	12.41
NSYSPS4200	200mm High x 400mm Deep	14.55
NSYSPS5200	200mm High x 500mm Deep	16.88
NSYSPS6200	200mm High x 600mm Deep	18.93

**Accessories for NSYSF Enclosures**

REF NO	Description	PRICE
NSYSFBK	Coupling kit for joining enclosures side by side or depth wise	17.05
NSYSFELB	Set of lifting and transport brackets which fix to the structure of 2 joined enclosures	18.33
NSYSFEB	Set of 4 Eyebolts which screw directly to the structure of the enclosure	13.57
NSYIN405E1	405E Key Lock Insert	10.98
NSYIN1242E1	1242E Key Lock Insert	10.98

**IP55 RAL7035**  
**Spacial NSYSF with Mounting Plate 2000mm High**

REF NO	Dimensions (mm) H x W x D	No. of Doors	PRICE
<b>400mm Deep</b>			
NSYSF20640P	2000 x 600 x 400	1	477.20
NSYSF20840P	2000 x 800 x 400	1	502.30
NSYSF201040P	2000 x 1000 x 400	1	627.88
NSYSF201040ZDP	2000 x 1000 x 400	2	703.25
NSYSF201240ZDP	2000 x 1200 x 400	2	753.47
NSYSF201640ZDP	2000 x 1600 x 400	2	929.26
NSY2SP204	Pair of side panels - 2000mm x 400mm		110.50
NSYPPS204	Partition panel for separating 2 bayed enclosures - 2000mmH x 400mmD		65.44
<b>500mm Deep</b>			
NSYSF20650P	2000 x 600 x 500	1	487.13
NSYSF20850P	2000 x 800 x 500	1	512.79
NSYSF201050P	2000 x 1000 x 500	1	640.44
NSYSF201050ZDP	2000 x 1000 x 500	2	717.86
NSYSF201250ZDP	2000 x 1200 x 500	2	769.18
NSYSF201650ZDP	2000 x 1600 x 500	2	948.63
NSY2SP205	Pair of side panels - 2000mm x 500mm		112.80
NSYPPS205	Partition panel for separating 2 bayed enclosures - 2000mmH x 500mmD		78.74

NSYSF20640P



**IP55 RAL7035**  
**Spacial NSYSF with Mounting Plate 2000mm High**

REF NO	Dimensions (mm) H x W x D	No. of Doors	PRICE
<b>600mm Deep</b>			
NSYSF20660P	2000 x 600 x 600	1	497.09
NSYSF20860P	2000 x 800 x 600	1	523.23
NSYSF20860ZDP	2000 x 800 x 600	2	654.03
NSYSF201060P	2000 x 1000 x 600	1	654.03
NSYSF201060ZDP	2000 x 1000 x 600	2	732.55
NSYSF201260ZDP	2000 x 1200 x 600	2	784.87
NSYSF201660ZDP	2000 x 1600 x 600	2	967.93
NSY2SP206	Pair of side panels - 2000mm x 600mm		115.11
NSYPPS206	Partition panel for separating 2 bayed enclosures - 2000mmH x 600mmD		80.77
<b>800mm Deep</b>			
NSYSF20680P	2000 x 600 x 800	1	571.62
NSYSF20880P	2000 x 800 x 800	1	601.70
NSYSF201080P	2000 x 1000 x 800	1	752.15
NSYSF201280ZDP	2000 x 1200 x 800	2	902.61
NSY2SP208	Pair of side panels - 2000mm x 800mm		132.38
NSYPPS208	Partition panel for separating 2 bayed enclosures - 2000mmH x 800mmD		85.21

**IP55 RAL7035**  
**Spacial NSYSF with Mounting Plate 2200mm High**

REF NO	Dimensions (mm) H x W x D	No. of Doors	PRICE
<b>600mm Deep</b>			
NSYSF22660P	2200 x 600 x 600	1	546.77
NSYSF22860P	2200 x 800 x 600	1	575.54
NSYSF221060P	2200 x 1000 x 600	1	791.32
NSYSF221260ZDP	2200 x 1200 x 600	2	863.36
NSY2SP226	Pair of side panels - 2200mm x 600mm		126.62
NSYPPS226	Partition panel for separating 2 bayed enclosures - 2200mmH x 600mmD		86.66
<b>800mm Deep</b>			
NSYSF22680P	2200 x 600 x 800	1	628.78
NSYSF22880P	2200 x 800 x 800	1	661.87
NSYSF221280ZDP	2200 x 1200 x 800	1	992.86
NSY2SP228	Pair of side panels - 2200mm x 800mm		145.61
NSYPPS228	Partition panel for separating 2 bayed enclosures - 2200mmH x 800mmD		90.12

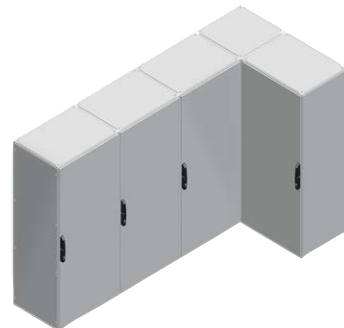

**Bottom Cable Entry Plates**

The Spacial SF enclosures are supplied without a cable entry plate which should be ordered separately.

REF NO	Description	PRICE
NSYEC641	600W x 400D Cable Entry Plate - 1 Entry	21.35
NSYEC841	800W x 400D Cable Entry Plate - 1 Entry	23.18
NSYEC1041	1000W x 400D Cable Entry Plate - 1 Entry	32.78
NSYEC1241	1200W x 400D Cable Entry Plate - 1 Entry	39.91
NSYEC1641	1600W x 400D Cable Entry Plate - 1 Entry	48.75
NSYEC651	600W x 500D Cable Entry Plate - 1 Entry	21.23
NSYEC851	800W x 500D Cable Entry Plate - 1 Entry	26.17
NSYEC1051	1000W x 500D Cable Entry Plate - 1 Entry	33.11
NSYEC1251	1200W x 500D Cable Entry Plate - 1 Entry	44.18
NSYEC1651	1600W x 500D Cable Entry Plate - 1 Entry	52.43
NSYEC661	600W x 600D Cable Entry Plate - 1 Entry	22.33
NSYEC662	600W x 600D Cable Entry Plate - 2 Entries	28.99
NSYEC861	800W x 600D Cable Entry Plate - 1 Entry	29.38
NSYEC862	800W x 600D Cable Entry Plate - 2 Entries	35.56
NSYEC1061	1000W x 600D Cable Entry Plate - 1 Entry	39.57
NSYEC1062	1000W x 600D Cable Entry Plate - 2 Entries	38.70
NSYEC1261	1200W x 600D Cable Entry Plate - 1 Entry	54.42
NSYEC1262	1200W x 600D Cable Entry Plate - 2 Entries	58.56
NSYEC1661	1600W x 600D Cable Entry Plate - 1 Entry	59.17
NSYEC1662	1600W x 600D Cable Entry Plate - 2 Entries	64.74
NSYEC681	600W x 800D Cable Entry Plate - 1 Entry	24.41
NSYEC682	600W x 800D Cable Entry Plate - 2 Entries	31.75
NSYEC881	800W x 800D Cable Entry Plate - 1 Entry	40.26
NSYEC882	800W x 800D Cable Entry Plate - 2 Entries	39.71
NSYEC1081	1000W x 800D Cable Entry Plate - 1 Entry	35.77
NSYEC1082	1000W x 800D Cable Entry Plate - 2 Entries	44.34
NSYEC1281	1200W x 800D Cable Entry Plate - 1 Entry	64.47
NSYEC1282	1200W x 800D Cable Entry Plate - 2 Entries	66.97

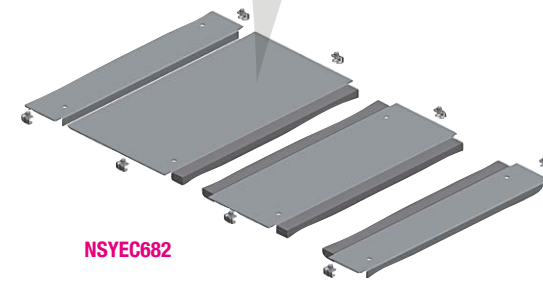

**Intermediate Mounting Plates for NSYSF Enclosures**

REF NO	Description	PRICE
NSYSIMP18	To suit 1800mmH bayed enclosures	51.08
NSYSIMP20	To suit 2000mmH bayed enclosures	54.01
NSYSIMP22	To suit 2200mmH bayed enclosures	57.50

**Front / Rear Plinth Sections for NSYSF Enclosures**

The NSYSF plinths are supplied in two parts and need to be ordered separately. The front/rear sections comprise four corner pieces with removable covers. They are available in 100mm or 200mm heights in dark grey to RAL7022.

REF NO	Description	PRICE
NSYSPPF6100	100mm High x 600mm Wide	35.82
NSYSPPF8100	100mm High x 800mm Wide	37.71
NSYSPPF10100	100mm High x 1000mm Wide	46.78
NSYSPPF12100	100mm High x 1200mm Wide	58.54
NSYSPPF16100	100mm High x 1600mm Wide	67.21
NSYSPPF6200	200mm High x 600mm Wide	64.47
NSYSPPF8200	200mm High x 800mm Wide	67.87
NSYSPPF10200	200mm High x 1000mm Wide	84.17
NSYSPPF12200	200mm High x 1200mm Wide	105.37
NSYSPPF16200	200mm High x 1600mm Wide	120.99

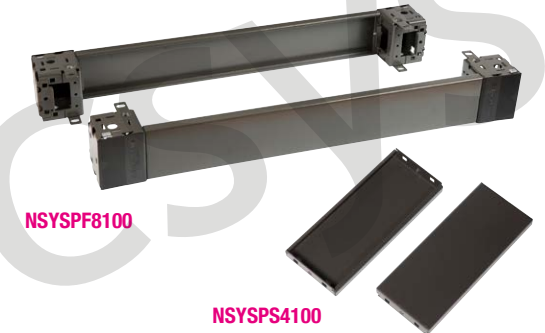

**Side Plinth Sections for NSYSF Enclosures**

REF NO	Description	PRICE
NSYSPPS4100	100mm High x 400mm Deep	10.23
NSYSPPS5100	100mm High x 500mm Deep	11.36
NSYSPPS6100	100mm High x 600mm Deep	12.41
NSYSPPS8100	100mm High x 800mm Deep	17.99
NSYSPPS4200	200mm High x 400mm Deep	14.55
NSYSPPS5200	200mm High x 500mm Deep	16.88
NSYSPPS6200	200mm High x 600mm Deep	18.93
NSYSPPS8200	200mm High x 800mm Deep	28.15

**Accessories for NSYSF Enclosures**

REF NO	Description	PRICE
NSYSFBK	Coupling kit for joining enclosures side by side or depth wise	17.05
NSYSFELB	Set of lifting and transport brackets which fix to the structure of 2 joined enclosures	18.33
NSYSFEB	Set of 4 Eyebolts which screw directly to the structure of the enclosure	13.57
NSYIN405E1	405E Key Lock Insert	10.98
NSYIN1242E1	1242E Key Lock Insert	10.98

The MKS/MKD range is manufactured from 1.5mm mild precision sheet steel, continuously rolled from top to bottom, folded and seam-welded in one of the corners. The rear panel is also manufactured from 1.5mm mild steel and welded to the frame.

The door is surface mounted with four hinges, can be left or right hand opening and has an external espagnolette 4 point locking fitted as standard with a double bit 3mm insert. The lock may be exchanged for standard inserts or a Swing Handle.

The MKS/MKD enclosures are IP55 and NEMA 12,13, IK10.

**IP55 RAL7035**  
MKS Enclosures with Mounting Plate

REF NO	Dimensions (mm) H x W x D	Weight kg	PRICE
MKS12064R5	1200 x 600 x 400	65.3	384.27
MKS12084R5	1200 x 800 x 400	74	459.94
MKS14063R5	1400 x 600 x 300	38.3	455.21
MKS14064R5	1400 x 600 x 400	73.6	480.81
MKS14083R5	1400 x 800 x 300	83.8	479.26
MKS14084R5	1400 x 800 x 400	89.0	509.85
MKS16063R5	1600 x 600 x 300	79.0	466.61
MKS16064R5	1600 x 600 x 400	81.9	475.34
MKS16083R5	1600 x 800 x 300	94.0	536.57
MKS16084R5	1600 x 800 x 400	99.1	535.88
MKS16085R5	1600 x 800 x 500	105.3	562.67
MKS16104R5	1600 x 1000 x 400	122.0	616.28
MKS16105R5	1600 x 1000 x 500	129.0	647.28
MKS18064R5	1800 x 600 x 400	90.2	486.61
MKS18084R5	1800 x 800 x 400	109.2	523.80
MKS18085R5	1800 x 800 x 500	111.7	593.49
MKS18104R5	1800 x 1000 x 400	128.3	640.27
MKS20064R5	2000 x 600 x 400	98.4	601.61
MKS20084R5	2000 x 800 x 400	119.3	686.92
MKS20085R5	2000 x 800 x 500	126.4	733.31
MKS20104R5	2000 x 1000 x 400	135.0	754.53
MKS20105R5	2000 x 1000 x 500	156.0	792.26



**IP55 RAL7035**  
MKD Enclosures with Mounting Plate

REF NO	Dimensions (mm) H x W x D	Weight kg	PRICE
MKD12124R5	1200 x 1200 x 400	108.0	623.58
MKD14103R5	1400 x 1000 x 300	101.2	620.02
MKD14104R5	1400 x 1000 x 400	107.3	652.65
MKD14123R5	1400 x 1200 x 300	114.4	729.22
MKD14124R5	1400 x 1200 x 400	123.3	762.60
MKD16124R5	1600 x 1200 x 400	135.7	726.42
MKD16125R5	1600 x 1200 x 500	145.0	856.57
MKD18124R5	1800 x 1200 x 400	151.9	744.54
MKD18125R5	1800 x 1200 x 500	159.5	885.94
MKD18164R5	1800 x 1600 x 400	198.0	916.56
MKD18165R5	1800 x 1600 x 500	216.0	989.88
MKD20124R5	2000 x 1200 x 400	166.8	896.06
MKD20125R5	2000 x 1200 x 500	175.0	980.81
MKD20164R5	2000 x 1600 x 400	216.4	1075.57
MKD20165R5	2000 x 1600 x 500	234.0	1219.70



MKS18084R5

Front / Rear Plinth Sections for MKS / MKD Enclosures

The Eldon plinths are supplied in two parts and need to be ordered separately. The front/rear sections comprise four corner pieces with removable covers. They are available in 100mm or 200mm heights in dark grey to RAL7022. Fixings are supplied with the front/rear plinth sections (PF part nos.)

REF NO	Description	PRICE
PF1060	100mm High x 600mm Wide	36.02
PF1080	100mm High x 800mm Wide	37.20
PF1100	100mm High x 1000mm Wide	48.34
PF1120	100mm High x 1200mm Wide	49.38
PF2060	200mm High x 600mm Wide	58.16
PF2080	200mm High x 800mm Wide	71.50
PF2100	200mm High x 1000mm Wide	92.05
PF2120	200mm High x 1200mm Wide	99.85

For enclosures 1600mm wide, use 2 x 800mm wide plinths

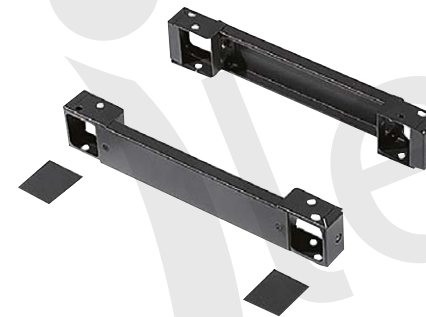

Side Plinth Sections for MKS / MKD Enclosures

REF NO	Description	PRICE
PS1030	100mm High x 300mm Deep	18.37
PS1040	100mm High x 400mm Deep	20.27
PS1050	100mm High x 500mm Deep	22.00
PS2030	200mm High x 300mm Deep	26.95
PS2040	200mm High x 400mm Deep	28.26
PS2050	200mm High x 500mm Deep	31.40

A full range of Trunking, Sleeving and Accessories are available in

**Cable Management**

Pages 128-141



LI\*\*\*

Eldon Lock Variations - LI Inserts

LI inserts may be used to replace the 3mm DIN lock that is supplied as standard with these enclosures

REF NO	Description	PRICE
LI503	3mm DIN insert	3.43
LI505	5mm DIN insert	3.76
LI526	Triangle 7mm insert	3.76
LI527	Triangle 8mm insert	3.76



LLH501

LHC522

LHC536

Eldon LLH Swing Handle & Inserts

The LLH swing handle and LHC inserts are a complete lock replacement for the MKS/MKD range of enclosures

REF NO	Description	PRICE
LLH501	Swing handle for LSSI inserts	45.72
LLH503	Swing handle with padlock facility	51.66
LHC522	Round cylinder Ronis Key C21323	16.04
LHC526	7mm Triangle	7.38
LHC527	8mm Triangle	7.38
LHC528	3mm Double Bit	7.38
LHC529	5mm Double Bit	7.38
LHC536	Push button only	7.38

The MCS/MCD range of mild steel floor standing enclosures is a suite style enclosure. The enclosures can be bayed together to form a continuous enclosure. In addition, these enclosures have removable rear panels which can be replaced for rear doors if required.

The door is surface mounted with four hinges, can be left or right hand opening wand has an external espagnolette 4 point locking fitted as standard with a double bit 3mm insert. The lock may be exchanged for standard inserts or a Swing Handle.

MCS/MCD enclosures are IP55, NEMA 4,12,13, IK10.

The door may be exchanged for a glazed version if required.



MCD18124R5

**IP55 RAL7035**  
MCS/MCD Suite Enclosures - 1800mm High  
Front Door & Rear Panel

REF NO	Dimensions (mm)			No. of Doors	PRICE
	H	x W	x D		
<b>500mm Deep</b>					
MCS18055R5	1800	x 500	x 500	1	527.92
MCS18065R5	1800	x 600	x 500	1	555.71
MCS18085R5	1800	x 800	x 500	1	599.37
MCS18105R5	1800	x 1000	x 500	1	749.34
MCD18085R5	1800	x 800	x 500	2	669.97
MCD18105R5	1800	x 1000	x 500	2	833.75
MCD18125R5	1800	x 1200	x 500	2	838.77
SPM1805R5	Pair of side panels - 1800mm x 500mm				133.10
SPD1805	Plate for separating two bayed enclosures - 1800mmH x 500mmD				76.61
<b>600mm Deep</b>					
MCS18066R5	1800	x 600	x 600	1	608.29
MCS18086R5	1800	x 800	x 600	1	669.00
MCS18106R5	1800	x 1000	x 600	1	786.81
MCD18126R5	1800	x 1200	x 600	2	880.71
SPM1806R5	Pair of side panels - 1800mm x 600mm				147.56
SPD1806	Plate for separating two bayed enclosures - 1800mmH x 600mmD				88.41



MCS18066R5

**IP55 RAL7035**  
MCS/MCD Suite Enclosures - 1800mm High  
Front Door & Rear Panel

REF NO	Dimensions (mm)			No. of Doors	PRICE
	H	x W	x D		
<b>400mm Deep</b>					
MCS18064R5	1800	x 600	x 400	1	509.20
MCS18084R5	1800	x 800	x 400	1	579.50
MCS18104R5	1800	x 1000	x 400	1	713.66
MCD18104R5	1800	x 1000	x 400	2	735.24
MCD18124R5	1800	x 1200	x 400	2	773.65
MCD18164R5	1800	x 1600	x 400	2	1044.43
SPM1804R5	Pair of side panels - 1800mm x 400mm				116.67
SPD1804	Plate for separating two bayed enclosures - 1800mmH x 400mmD				64.55

**IP55 RAL7035**  
MCS/MCD Suite Enclosures - 2000mm High  
Front Door & Rear Panel

REF NO	Dimensions (mm)			No. of Doors	PRICE
	H	x W	x D		
<b>400mm Deep</b>					
MCS20064R5	2000	x 600	x 400	1	551.25
MCS20084R5	2000	x 800	x 400	1	618.65
MCS20104R5	2000	x 1000	x 400	1	742.38
MCD20104R5	2000	x 1000	x 400	2	818.29
MCD20124R5	2000	x 1200	x 400	2	885.56
MCD20164R5	2000	x 1600	x 400	2	1195.51
SPM2004R5	Pair of side panels - 2000H x 400D				117.40
SPD2004	Plate for separating two bayed enclosures - 2000H x 400D				80.97
<b>500mm Deep</b>					
MCS20065R5	2000	x 600	x 500	1	590.45
MCS20085R5	2000	x 800	x 500	1	632.01
MCS20105R5	2000	x 1000	x 500	1	758.41
MCD20085R5	2000	x 800	x 500	2	785.35
MCD20105R5	2000	x 1000	x 500	2	826.23
MCD20125R5	2000	x 1200	x 500	2	900.21
MCD20165R5	2000	x 1600	x 500	2	1215.28
SPM2005R5	Pair of side panels - 2000H x 500D				134.72
SPD2005	Plate for separating two bayed enclosures - 2000H x 500D				88.41
<b>600mm Deep</b>					
MCS20066R5	2000	x 600	x 600	1	618.65
MCS20086R5	2000	x 800	x 600	1	647.31
MCS20106R5	2000	x 1000	x 600	1	776.77
MCD20106R5	2000	x 1000	x 600	2	860.26
MCD20126R5	2000	x 1200	x 600	2	917.24
MCD20166R5	2000	x 1600	x 600	2	1238.27
SPM2006R5	Pair of side panels - 2000H x 600D				141.08
SPD2006	Plate for separating two bayed enclosures - 2000H x 600D				96.72
<b>800mm Deep</b>					
MCS20068R5	2000	x 600	x 800	1	685.11
MCS20088R5	2000	x 800	x 800	1	743.95
MCS20108R5	2000	x 1000	x 800	1	892.74
MCD20108R5	2000	x 1000	x 800	2	1015.21
MCD20128R5	2000	x 1200	x 800	2	1068.64
SPM2008R5	Pair of side panels - 2000H x 800D				174.22
SPD2008	Plate for separating two bayed enclosures - 2000H x 800D				112.50

**IP55 RAL7035**  
MCS/MCD Suite Enclosures - 2200mm High  
Front Door & Rear Panel

REF NO	Dimensions (mm)			No. of Doors	PRICE
	H	x W	x D		
<b>600mm Deep</b>					
MCS22066R5	2200	x 600	x 600	1	657.66
MCS22086R5	2200	x 800	x 600	1	706.23
MCD22106R5	2200	x 1000	x 600	2	974.57
MCD22126R5	2200	x 1200	x 600	2	1025.86
SPM2206R5	Pair of side panels - 2200H x 600D				157.90
SPD2206	Plate for separating two bayed enclosures - 2200H x 600D				104.49
<b>800mm Deep</b>					
MCS22068R5	2200	x 600	x 800	1	723.43
MCS22088R5	2200	x 800	x 800	1	776.85
SPM2208R5	Pair of side panels - 2200H x 800D				191.49
SPD2208	Plate for separating two bayed enclosures - 2200H x 800D				135.83



**Extra Wide Mounting Plates for MCS/MCD Enclosures**

The wide mounting plates create an installation surface which is the full width of the enclosure. Support slides should be used for ease of installation.

REF NO	Description	PRICE
MPW1806	Extra wide plate for 1800H x 600W Enclosure	229.67
MPW2006	Extra wide plate for 2000H x 600W Enclosure	241.15
MTS600	Support slides for above	47.12
MPW1808	Extra wide plate for 1800H x 800W Enclosure	255.19
MPW2008	Extra wide plate for 2000H x 800W Enclosure	267.95
MTS800	Support slides for above	51.73
MPW1810	Extra wide plate for 1800H x 1000W Enclosure	279.88
MPW2010	Extra wide plate for 2000H x 1000W Enclosure	293.87
MTS1000	Support slides for above	56.34
MPW1812	Extra wide plate for 1800H x 1200W Enclosure	327.63
MPW2012	Extra wide plate for 2000H x 1200W Enclosure	344.01
MTS1200	Support slides for above	60.95

A mounting plate is included with each enclosure for the part numbers listed. Most sizes of enclosures are also available without the mounting plate if required.

For accessories, including plinths and locks, see following pages.

**Eldon Lifting Eyes & Brackets**

REF NO	Description	PRICE
LE9304	Set of 4 x M12 Lifting Eyes	16.13
LC02	Bracket for externally fixing two enclosures for lifting when bayed together. To be used in combination with CCM04	14.53
CCM04	Internal corner baying kit to be used in combination with LC12 for lifting	27.41
CCE06	Pack of six brackets for external baying of two enclosures	11.18
CCI06	Pack of six brackets for internal baying of two enclosures	38.56



CCE06



CCI06



LC02



CCM04

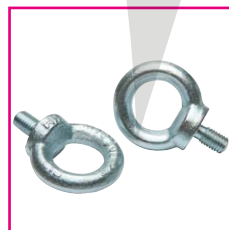

LE9304

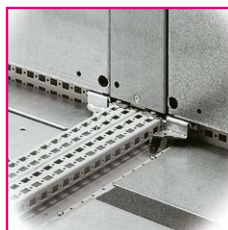

MPF1800

**Eldon Intermediate Plates**

The intermediate plates may be used to fill the gap between the two standard plates to ensure surface continuity when joining two or more enclosures together

REF NO	Description	PRICE
MPF1800	Intermediate plate - 1800mm high	66.42
MPF2000	Intermediate plate - 2000mm high	64.72
MPF2200	Intermediate plate - 2200mm high	77.68

**Eldon Castors & Feet**

REF NO	Description	PRICE
LCR470	Set of 4 Castors	64.93
LCR471	As above however two castors fitted with brakes	113.28
LF430	Set of four adjustable feet for direct fitting to enclosures. Maximum load - 300kg per foot	32.74



LCR470

**Eldon MultiFlex Lock Variations - LI Inserts**

LI inserts may be used to replace the 3mm DIN lock that is supplied as standard with these enclosures

REF NO	Description	PRICE
LI503	3mm DIN insert	3.43
LI505	5mm DIN insert	3.76
LI523	Square 7mm Insert	3.76
LI524	Square 8mm Insert	3.76
LI526	Triangle 7mm insert	3.76
LI527	Triangle 8mm insert	3.76



LI5\*\*



LSK505

**Eldon LSK Keys**

REF NO	Description	PRICE
LSK503	DIN 3mm key	4.90
LSK505	DIN 5mm key	4.90
LSK523	Square 7mm key	4.90
LSK524	Square 8mm key	4.90
LSK526	Triangle 7mm key	4.90
LSK527	Triangle 8mm key	4.90



LLH501

LHC522

LHC536

LLTH560

**Eldon Handles**

The LLH swing handle and LHC inserts are a complete lock replacement for the MultiFlex range of enclosures

REF NO	Description	PRICE
LLH501	Swing handle for LHC inserts	45.72
LLH503	Swing handle with padlock facility	51.66
LHC521	Profile half cylinder Ronis Key C2123	25.02
LHC522	Round cylinder Ronis Key C21323	16.04
LHC536	Push button only	7.38
LLTH560	'T' Handle lock with Ronis cylinder key C21323	35.27
LLTH560CE	'T' Handle with no lock	21.46

**Front / Rear Plinths for MCS / MCD Enclosures**

The Eldon plinths are supplied in two parts and need to be ordered separately. The front/rear sections comprise four corner pieces with removable covers. They are available in 100mm or 200mm heights in dark grey to RAL7022. Fixings are supplied with the front/rear plinth sections (PF part nos.)

REF NO	Description	PRICE
PF1050	100mm High x 500mm Wide	34.58
PF1060	100mm High x 600mm Wide	36.02
PF1080	100mm High x 800mm Wide	37.20
PF1100	100mm High x 1000mm Wide	48.34
PF1120	100mm High x 1200mm Wide	49.38
PF2050	200mm High x 500mm Wide	56.55
PF2060	200mm High x 600mm Wide	58.16
PF2080	200mm High x 800mm Wide	71.50
PF2100	200mm High x 1000mm Wide	92.05
PF2120	200mm High x 1200mm Wide	99.85

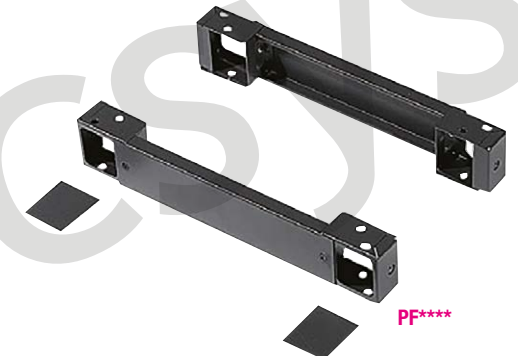

PF\*\*\*

**Side Plinths for MCS / MCD Enclosures**

REF NO	Description	PRICE
PS1040	100mm High x 400mm Deep	20.27
PS1050	100mm High x 500mm Deep	22.00
PS1060	100mm High x 600mm Deep	24.69
PS2040	200mm High x 400mm Deep	28.26
PS2050	200mm High x 500mm Deep	31.40
PS2060	200mm High x 600mm Deep	33.93



PS\*\*\*

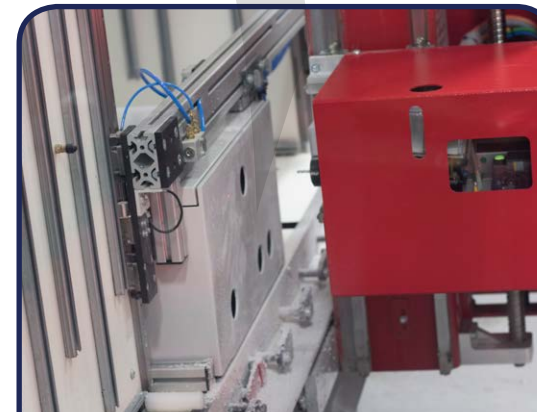

**iLECSYS**  
**In-House Engineering**

Enclosures machined to your specifications.  
Please call for details: **01844 397300**

The Eldon Stainless Steel Floor Standing Enclosures are readily available in AISI 304 with AISI 316L to order.

They feature a one piece enclosure body with removable back panel and integrated depth profiles which allows the galvanised steel backplate to be mounted at the desired depth.

Single doors are IP66, NEMA 4x, 12, 13, IK10 and Double door enclosures are IP55, NEMA 12, 13, IK10.

**316L grade enclosures and 200mm high plinth options are also available. Contact us for more information.**

## IP66 EKSS 304 Single Door Enclosures with Mounting Plate

REF NO	Dimensions (mm) H x W x D	Weight kg	PRICE
EKSS14084	1400 x 800 x 400	85.0	1900.81
EKSS16064	1600 x 600 x 400	81.9	2000.87
EKSS16084	1600 x 800 x 400	94	2213.35
EKSS16104	1600 x 1000 x 400	122.4	2568.04
EKSS18064	1800 x 600 x 400	90	2031.56
EKSS18084	1800 x 800 x 400	109	2329.84
EKSS18104	1800 x 1000 x 400	128.3	2703.20
EKSS20084	2000 x 800 x 400	119.3	2841.01
EKSS20104	2000 x 1000 x 400	135	2922.16



EKDS18164

## IP55 EKDS 304 Double Door Enclosures with Mounting Plate

REF NO	Dimensions (mm) H x W x D	Weight kg	PRICE
EKDS12124	1200 x 1200 x 400	108	2593.96
EKDS16124	1600 x 1200 x 400	135.7	3187.60
EKDS18124	1800 x 1200 x 400	151.9	3391.06
EKDS18164	1800 x 1600 x 400	198	4001.17
EKDS20124	2000 x 1200 x 400	166.8	3607.51
EKDS20164	2000 x 1600 x 400	216.4	4262.86



### Front / Rear Plinths for EKSS / EKDS Enclosures

The Eldon plinths are supplied in two parts and need to be ordered separately. The front/rear sections comprise four corner pieces with removable covers. Fixings are supplied with the front/rear plinth sections (PFS part nos.)

REF NO	Description	PRICE
<b>100mm Fronts</b>		
PFS1060	100mm High x 600mm Wide	125.64
PFS1080	100mm High x 800mm Wide	143.12
PFS1100	100mm High x 1000mm Wide	160.60
PFS1120	100mm High x 1200mm Wide	178.08
<b>100mm Sides</b>		
PSS1040	100mm High x 400mm Wide	73.32



### IP55 NSYSMX Floor Standing Enclosures - 304

REF NO	Dimensions (mm) H x W x D	No. of Doors	PRICE
<b>1400mm High</b>			
NSYSMX141030	1400 x 1000 x 300	2	2595.57
<b>1600mm High</b>			
NSYSMX16840	1600 x 800 x 400	1	2177.98
<b>1800mm High</b>			
NSYSMX18640	1800 x 600 x 400	1	2235.35
NSYSMX18840	1800 x 800 x 400	1	2036.85
NSYSMX181240	1800 x 1200 x 400	2	2303.62
NSYSMX181640	1800 x 1600 x 400	2	3387.93
<b>2000mm High</b>			
NSYSMX20850	2000 x 800 x 500	1	2225.55
NSYSMX201040	2000 x 1000 x 400	2	2837.40
NSYSMX201250	2000 x 1200 x 500	2	3071.79
NSYSMX201660	2000 x 1600 x 600	2	3296.28



NSYSMX20850

### Mounting Plates for NSYSMX Stainless Steel Enclosures

Mounting plates for the NSYSMX should be ordered separately. They are manufactured from galvanised steel.

REF NO	Description	PRICE
NSYMP1410	Mounting Plate 1400mmH x 1000mmW	68.74
NSYMP168	Mounting Plate 1600mmH x 800mmW	68.70
NSYMP186	Mounting Plate 1800mmH x 600mmW	63.90
NSYMP188	Mounting Plate 1800mmH x 800mmW	67.26
NSYMP1812	Mounting Plate 1800mmH x 1200mmW	100.89
NSYMP1816	Mounting Plate 1800mmH x 1600mmW	124.42
NSYMP208	Mounting Plate 2000mmH x 800mmW	72.00
NSYMP2010	Mounting Plate 2000mmH x 1000mmW	81.63
NSYMP2012	Mounting Plate 2000mmH x 1200mmW	97.95
NSYMP2016	Mounting Plate 2000mmH x 1600mmW	128.80

The NSYSMX IP55 Floor Standing enclosures have been specially designed for the chemical, oil and food/beverage industries where hygiene and resistance to corrosion are important. The standard supply is AISI304 with AISI 316L also being available to special order.

Single doors are IP55 NEMA 1, 2, 3, 3R, 4, 4x, 12, 12K, 13, IK10 and Double door enclosures are IP55, NEMA 1, 2, 12K, IK10.

The enclosures have a 3 point locking system with handle made from painted Zamak and come supplied with a single piece cable gland plate.

### Plinth Sections for NSYSMX Stainless Steel Enclosures

These are supplied in two parts and need to be ordered separately. They are manufactured from 304L Stainless Steel

REF NO	Description	PRICE
<b>Front/Back Section</b>		
NSYSFPX6100	100mm High x 600mm Wide	293.40
NSYSFPX8100	100mm High x 800mm Wide	314.01
NSYSFPX10100	100mm High x 1000mm Wide	305.99
NSYSFPX12100	100mm High x 1200mm Wide	381.51
NSYSFPX16100	100mm High x 1600mm Wide	394.80
<b>Side Sections</b>		
NSYSPSX3100	100mm High x 300mm Deep	73.59
NSYSPSX4100	100mm High x 400mm Deep	66.29
NSYSPSX5100	100mm High x 500mm Deep	77.51
NSYSPSX6100	100mm High x 600mm Deep	117.51



NSYSFPX8100



NSYSMEB

### Accessories

REF NO	Description	PRICE
NSYSMEB	Set of 4 x M12 Eyebolts	15.81

The Cubo S is a range of small to medium sized enclosures. They are ideal for housing electronic and electromechanical equipment and available in Polycarbonate or ABS.

**Polycarbonate**

Operating Temperature -50°C to +100°C and UV stabilised. Flammability UL746C:5V. IP66/67. IK08 Standards: EN 62208, UL 508A, GOST

**ABS**

Operating Temperature -40°C to +60°C. Flammability UL94: HB. IP66/67. IK07



SABP131308G

**IP66/67 RAL7035**

Ensto Cubo S General Enclosures ABS with Grey Lid

REF NO	Dimensions (mm) W x H x D	Internal Depth (mm)	PRICE
SABP081304LG	75 x 125 x 35	20.5	9.52
SABP081305LG	75 x 125 x 50	35.5	11.23
SABP081306G	75 x 125 x 60	45.5	10.74
SABP081308LG	75 x 125 x 75	60.5	14.00
SABP081308G	75 x 125 x 75	60.5	11.48
SABP081310LG	75 x 125 x 100	85.5	12.77
SABP081310G	75 x 125 x 100	85.5	12.13
SABP081313G	75 x 125 x 125	110.5	12.58
SABP101004LG	100 x 100 x 35	20.5	9.16
SABP101006G	100 x 100 x 60	45.5	10.29
SABP131304LG	125 x 125 x 35	20.5	10.19
SABP131305LG	125 x 125 x 50	35.5	11.97
SABP131306G	125 x 125 x 60	45.5	11.52
SABP131308LG	125 x 125 x 75	60.5	14.03
SABP131308G	125 x 125 x 75	60.5	12.42
SABP131310LG	125 x 125 x 100	85.5	14.87
SABP131310G	125 x 125 x 100	85.5	13.61
SABP131313G	125 x 125 x 125	110.5	13.97

**IP66/67 RAL7035**

Ensto Cubo S General Enclosures ABS with Grey Lid

REF NO	Dimensions (mm) W x H x D	Internal Depth (mm)	PRICE
SABP131804LG	125 x 175 x 35	20.5	11.74
SABP131805LG	125 x 175 x 50	35.5	13.74
SABP131806G	125 x 175 x 60	45.5	13.13
SABP131808LG	125 x 175 x 75	60.5	15.16
SABP131808G	125 x 175 x 75	60.5	14.48
SABP131810LG	125 x 175 x 100	85.5	20.00
SABP131810G	125 x 175 x 100	85.5	15.74
SABP131813LG	125 x 175 x 125	110.5	19.48
SABP131813G	125 x 175 x 125	110.5	16.32
SABP131815G	125 x 175 x 150	135.5	17.32
SABP132513G	125 x 250 x 125	110.5	21.29
SABP181808G	175 x 175 x 75	60.5	18.42
SABP181810G	175 x 175 x 100	85.5	19.90
SABP181813G	175 x 175 x 125	110.5	20.90
SABP181815G	175 x 175 x 150	135.5	26.42
SABP182508G	175 x 250 x 75	60.5	27.84
SABP182510G	175 x 250 x 100	85.5	29.61
SABP182515G	175 x 250 x 150	135.5	35.29



Bases are 50mm deep unless there is a suffix L. Suffix L indicates a lower base of 25mm.

The remaining overall depth of the enclosure is made up with the depth of the lid.

G = Grey Lid; T = Transparent Lid

**IP66/67 RAL7035**

Ensto Cubo S General Enclosures ABS with Transparent Lid

REF NO	Dimensions (mm) W x H x D	Internal Depth (mm)	PRICE
SABP081304LT	75 x 125 x 35	20.5	10.32
SABP081305LT	75 x 125 x 50	35.5	12.06
SABP081306T	75 x 125 x 60	45.5	11.58
SABP081308LT	75 x 125 x 75	60.5	15.42
SABP081308T	75 x 125 x 75	60.5	13.45
SABP081310LT	75 x 125 x 100	85.5	14.29
SABP081310T	75 x 125 x 100	85.5	14.00
SABP081313T	75 x 125 x 125	110.5	15.00
SABP101004LT	100 x 100 x 35	20.5	9.87
SABP101006T	100 x 100 x 60	45.5	11.06
SABP131304LT	125 x 125 x 35	20.5	12.45
SABP131305LT	125 x 125 x 50	35.5	13.03
SABP131306T	125 x 125 x 60	45.5	12.45
SABP131308LT	125 x 125 x 75	60.5	15.61
SABP131308T	125 x 125 x 75	60.5	14.10
SABP131310LT	125 x 125 x 100	85.5	16.94
SABP131310T	125 x 125 x 100	85.5	15.94
SABP131313T	125 x 125 x 125	110.5	16.32



SABP101004LT

**Ensto Cubo S Accessories**

REF NO	Description	PRICE
DSHI-1	Pair of external hinges for use on 80mm x 82mm enclosures or larger	7.48
SFL-1	Set of 4 wall fastening lugs	2.71



SFL-1

DSHI-1



SABP181815T

**IP66/67 RAL7035**

Ensto Cubo S General Enclosures ABS with Transparent Lid

REF NO	Dimensions (mm) W x H x D	Internal Depth (mm)	PRICE
SABP131804LT	125 x 175 x 35	20.5	12.26
SABP131805LT	125 x 175 x 50	35.5	15.55
SABP131806T	125 x 175 x 60	45.5	14.74
SABP131808LT	125 x 175 x 75	60.5	15.29
SABP131808T	125 x 175 x 75	60.5	16.55
SABP131810LT	125 x 175 x 100	85.5	22.81
SABP131810T	125 x 175 x 100	85.5	18.52
SABP131813LT	125 x 175 x 125	110.5	23.32
SABP131813T	125 x 175 x 125	110.5	19.19
SABP131815T	125 x 175 x 150	135.5	20.90
SABP132513T	125 x 250 x 125	110.5	27.03
SABP181808T	175 x 175 x 75	60.5	21.23
SABP181810T	175 x 175 x 100	85.5	23.74
SABP181813T	175 x 175 x 125	110.5	24.58
SABP181815T	175 x 175 x 150	135.5	30.58
SABP182508T	175 x 250 x 75	60.5	31.94
SABP182510T	175 x 250 x 100	85.5	34.90
SABP182515T	175 x 250 x 150	135.5	41.45

**Ensto Cubo S Steel Mounting Plates**

The Ensto Cubo S mounting plates are made from 1.5mm thick galvanised steel

REF NO	Plate Size (mm) W x H	Enclosure Size (mm) W x H	PRICE
SMP1010	78 x 78	100 x 100	2.87
SMP0813	48 x 98	75 x 125	2.71
SMP1313	98 x 98	125 x 125	3.90
SMP1318	98 x 148	125 x 175	4.06
SMP1325	98 x 223	125 x 250	5.26
SMP1818	148 x 148	175 x 175	5.45
SMP1825	148 x 223	175 x 250	5.45

SMP1818



# Ensto Cubo S Polycarbonate Enclosures with Grey Lid

# Ensto Cubo S Polycarbonate Enclosures with Transparent Lid

The Cubo S is a range of small to medium sized enclosures. They are ideal for housing electronic and electromechanical equipment and available in Polycarbonate or ABS.

### Polycarbonate

Operating Temperature -50°C to +100°C and U.V stabilised. Flammability UL746C:5V. IP66/67. IK08 Standards: EN 62208, UL 508A, GOST.

### ABS

Operating Temperature -40°C to +60°C. Flammability UL94: HB. IP66/67. IK07.



## IP66/67 RAL7035 Ensto Cubo S General Enclosures Polycarbonate with Grey Lid

REF NO	Dimensions (mm) W x H x D	Internal Depth (mm)	PRICE
SPCP081304LG	75 x 125 x 35	20.5	11.45
SPCP081305LG	75 x 125 x 50	35.5	13.16
SPCP081306G	75 x 125 x 60	45.5	13.26
SPCP081308LG	75 x 125 x 75	60.5	16.55
SPCP081308G	75 x 125 x 75	60.5	14.94
SPCP081310LG	75 x 125 x 100	85.5	15.32
SPCP081310G	75 x 125 x 100	85.5	15.87
SPCP081313G	75 x 125 x 125	110.5	16.61
SPCP101004LG	100 x 100 x 35	20.5	10.94
SPCP101006G	100 x 100 x 60	45.5	12.68
SPCP131304LG	125 x 125 x 35	20.5	12.45
SPCP131305LG	125 x 125 x 50	35.5	14.42
SPCP131306G	125 x 125 x 60	45.5	14.48
SPCP131308LG	125 x 125 x 75	60.5	17.03
SPCP131308G	125 x 125 x 75	60.5	16.52
SPCP131310LG	125 x 125 x 100	85.5	18.29
SPCP131310G	125 x 125 x 100	85.5	18.58
SPCP131313G	125 x 125 x 125	110.5	19.39

## IP66/67 RAL7035 Ensto Cubo S General Enclosures Polycarbonate with Grey Lid

REF NO	Dimensions (mm) W x H x D	Internal Depth (mm)	PRICE
SPCP131804LG	125 x 175 x 35	20.5	15.19
SPCP131805LG	125 x 175 x 50	35.5	17.48
SPCP131806G	125 x 175 x 60	45.5	17.58
SPCP131808LG	125 x 175 x 75	60.5	16.77
SPCP131808G	125 x 175 x 75	60.5	19.81
SPCP131810LG	125 x 175 x 100	85.5	25.52
SPCP131810G	125 x 175 x 100	85.5	21.65
SPCP131813LG	125 x 175 x 125	110.5	24.58
SPCP131813G	125 x 175 x 125	110.5	23.23
SPCP131815G	125 x 175 x 150	135.5	25.58
SPCP132513G	125 x 250 x 125	110.5	29.00
SPCP181808G	175 x 175 x 75	60.5	24.87
SPCP181810G	175 x 175 x 100	85.5	27.16
SPCP181813G	175 x 175 x 125	110.5	28.45
SPCP181815G	175 x 175 x 150	135.5	35.23
SPCP182508G	175 x 250 x 75	60.5	38.06
SPCP182510G	175 x 250 x 100	85.5	41.52
SPCP182515G	175 x 250 x 150	135.5	48.00



Bases are 50mm deep unless there is a suffix L. Suffix L indicates a lower base of 25mm.

The remaining overall depth of the enclosure is made up with the depth of the lid

G = Grey Lid; T = Transparent Lid



SPCP131306T

## IP66/67 RAL7035 Ensto Cubo S General Enclosures Polycarbonate with Transparent Lid

REF NO	Dimensions (mm) W x H x D	Internal Depth (mm)	PRICE
SPCP081304LT	75 x 125 x 35	20.5	11.61
SPCP081305LT	75 x 125 x 50	35.5	13.35
SPCP081306T	75 x 125 x 60	45.5	13.45
SPCP081308LT	75 x 125 x 75	60.5	16.74
SPCP081308T	75 x 125 x 75	60.5	15.13
SPCP081310LT	75 x 125 x 100	85.5	15.48
SPCP081310T	75 x 125 x 100	85.5	16.19
SPCP081313T	75 x 125 x 125	110.5	16.84
SPCP101004LT	100 x 100 x 35	20.5	11.06
SPCP101006T	100 x 100 x 60	45.5	12.84
SPCP131304LT	125 x 125 x 35	20.5	12.61
SPCP131305LT	125 x 125 x 50	35.5	14.65
SPCP131306T	125 x 125 x 60	45.5	14.71
SPCP131308LT	125 x 125 x 75	60.5	17.23
SPCP131308T	125 x 125 x 75	60.5	16.71
SPCP131310LT	125 x 125 x 100	85.5	18.45
SPCP131310T	125 x 125 x 100	85.5	19.00
SPCP131313T	125 x 125 x 125	110.5	19.39



SPCP081313T

### Ensto Cubo S Accessories

REF NO	Description	PRICE
DSHI-1	Pair of external hinges for use on 80mm x 82mm enclosures or larger	7.48
SFL-1	Set of 4 wall fastening lugs	2.71

## IP66/67 RAL7035 Ensto Cubo S General Enclosures Polycarbonate with Transparent Lid

REF NO	Dimensions (mm) W x H x D	Internal Depth (mm)	PRICE
SPCP131804LT	125 x 175 x 35	20.5	15.35
SPCP131805LT	125 x 175 x 50	35.5	17.68
SPCP131806T	125 x 175 x 60	45.5	17.74
SPCP131808LT	125 x 175 x 75	60.5	17.03
SPCP131808T	125 x 175 x 75	60.5	20.13
SPCP131810LT	125 x 175 x 100	85.5	25.84
SPCP131810T	125 x 175 x 100	85.5	22.10
SPCP131813LT	125 x 175 x 125	110.5	24.84
SPCP131813T	125 x 175 x 125	110.5	23.26
SPCP131815T	125 x 175 x 150	135.5	25.58
SPCP132513T	125 x 250 x 125	110.5	29.06
SPCP181808T	175 x 175 x 75	60.5	27.16
SPCP181810T	175 x 175 x 100	85.5	27.84
SPCP181813T	175 x 175 x 125	110.5	28.42
SPCP181815T	175 x 175 x 150	135.5	35.29
SPCP182508T	175 x 250 x 75	60.5	38.55
SPCP182510T	175 x 250 x 100	85.5	42.29
SPCP182515T	175 x 250 x 150	135.5	48.03



SPCP182510T

### Ensto Cubo S Steel Mounting Plates

The Ensto Cubo S mounting plates are made from 1.5mm thick galvanised steel

REF NO	Plate Size (mm)		Enclosures Size (mm)		PRICE
	W	H	W	H	
SMP1010	78	x 78	100	x 100	2.87
SMP0813	48	x 98	75	x 125	2.71
SMP1313	98	x 98	125	x 125	3.90
SMP1318	98	x 148	125	x 175	4.06
SMP1818	148	x 148	175	x 175	5.45
SMP1825	148	x 223	175	x 250	5.45



SMP1818

The Cubo S is a range of small to medium sized enclosures. The SPCM range are made from Polycarbonate and have Metric Knock-outs.

**Polycarbonate**  
Operating Temperature -50°C to +100°C and UV stabilised. Flammability UL746C:5V. IP66/67. IK08 Standards: EN 62208, UL 508A, GOST.



**IP66/67 RAL7035**  
Ensto Cubo S Polycarbonate Enclosures with Knock-Outs & Grey Lid

REF NO	Dimensions (mm) W x H x D	Internal Depth (mm)	PRICE
SPCM081306G	75 x 125 x 60	45.5	13.26
SPCM081308G	75 x 125 x 75	60.5	14.94
SPCM081310G	75 x 125 x 100	85.5	15.87
SPCM081313G	75 x 125 x 125	110.5	16.61
SPCM101006G	100 x 100 x 60	45.5	12.68
SPCM131306G	125 x 125 x 60	45.5	14.48
SPCM131308G	125 x 125 x 75	60.5	16.52
SPCM131310G	125 x 125 x 100	85.5	18.58
SPCM131313G	125 x 125 x 125	110.5	19.39
SPCM131806G	125 x 175 x 60	45.5	17.58
SPCM131808G	125 x 175 x 75	60.5	19.81
SPCM131810G	125 x 175 x 100	85.5	21.65
SPCM131813G	125 x 175 x 125	110.5	23.23
SPCM131815G	125 x 175 x 150	135.5	25.58
SPCM181808G	175 x 175 x 75	60.5	24.87
SPCM181810G	175 x 175 x 100	85.5	27.16
SPCM181813G	175 x 175 x 125	110.5	28.45
SPCM181815G	175 x 175 x 150	135.5	35.23
SPCM182508G	175 x 250 x 75	60.5	38.06
SPCM182510G	175 x 250 x 100	85.5	41.52
SPCM182515G	175 x 250 x 150	135.5	48.00

**IP66/67 RAL7035**

Ensto Cubo S Polycarbonate Enclosures with Knock-Outs & Transparent Lid

REF NO	Dimensions (mm) W x H x D	Internal Depth (mm)	PRICE
SPCM081306T	75 x 125 x 60	45.5	13.45
SPCM081308T	75 x 125 x 75	60.5	15.13
SPCM081310T	75 x 125 x 100	85.5	16.19
SPCM081313T	75 x 125 x 125	110.5	16.84
SPCM101006T	100 x 100 x 60	45.5	12.84
SPCM131306T	125 x 125 x 60	45.5	14.71
SPCM131308T	125 x 125 x 75	60.5	16.74
SPCM131310T	125 x 125 x 100	85.5	19.00
SPCM131313T	125 x 125 x 125	110.5	19.29
SPCM131806T	125 x 175 x 60	45.5	17.74
SPCM131808T	125 x 175 x 75	60.5	20.13
SPCM131810T	125 x 175 x 100	85.5	22.10
SPCM131813T	125 x 175 x 125	110.5	23.26
SPCM131815T	125 x 175 x 150	135.5	25.61
SPCM181808T	175 x 175 x 75	60.5	27.16
SPCM181810T	175 x 175 x 100	85.5	27.84
SPCM181813T	175 x 175 x 125	110.5	28.42
SPCM181815T	175 x 175 x 150	135.5	35.29
SPCM182508T	175 x 250 x 75	60.5	38.55
SPCM182510T	175 x 250 x 100	85.5	42.29
SPCM182515T	175 x 250 x 150	135.5	48.03



Ensto Cubo S Accessories

REF NO	Description	PRICE
DSHI-1	Pair of external hinges for use on 80mm x 82mm enclosures or larger	7.48
SFL-1	Set of 4 wall fastening lugs	2.71



Ensto Cubo S Steel Mounting Plates

The Ensto Cubo S mounting plates are made from 1.5mm thick galvanised steel

REF NO	Plate Size (mm)			Enclosures Size (mm)			PRICE
	W	x	H	W	x	H	
SMP1010	78	x	78	100	x	100	2.87
SMP0813	48	x	98	75	x	125	2.71
SMP1313	98	x	98	125	x	125	3.90
SMP1318	98	x	148	125	x	175	4.06
SMP1818	148	x	148	175	x	175	5.45
SMP1825	148	x	223	175	x	250	5.45



Comprehensive Engineering Services

- Design
- Machining
- Assembly
- Bulk Cable Cutting

Telephone  
**01844 397300**  
for further details



Ensto Cubo S Knock-Out Details

ENCLOSURE	Size & Quantity of Knock-Outs in Enclosure
SPCM081306	→ 2 x M16/M25 + 6 x M12/M20
SPCM081308	→ 2 x M16/M25 + 6 x M12/M20
SPCM081310	→ 2 x M16/M25 + 6 x M12/M20
SPCM081313	→ 2 x M16/M25 + 6 x M12/M20
SPCM101006	→ 1 x M16/M25 + 2 x M12/M20
SPCM131306	→ 6 x M12/M20 + 4 x M16/M25
SPCM131308	→ 4 x M16/M25 + 6 x M12/M20
SPCM131310	→ 4 x M16/M25 + 6 x M12/M20
SPCM131313	→ 4 x M16/M25 + 6 x M12/M20
SPCM131806	→ 4 x M16/M25 + 8 x M12/M20
SPCM131808	→ 4 x M16/M25 + 8 x M12/M20
SPCM131810	→ 4 x M16/M25 + 8 x M12/M20
SPCM131813	→ 4 x M16/M25 + 8 x M12/M20
SPCM131815	→ 4 x M16/M25 + 8 x M12/M20
SPCM181808	→ 4 x M12/M20 + 8 x M16/M25 + 10 x M12/M20
SPCM181810	→ 4 x M12/M20 + 8 x M16/M25 + 10 x M12/M20
SPCM181813	→ 4 x M12/M20 + 8 x M16/M25 + 10 x M12/M20
SPCM181815	→ 4 x M12/M20 + 8 x M16/M25 + 10 x M12/M20
SPCM182508	→ 4 x M12/M20 + 8 x M16/M25 + 12 x M12/M20
SPCM182510	→ 4 x M12/M20 + 8 x M16/M25 + 12 x M12/M20
SPCM182515	→ 4 x M12/M20 + 8 x M16/M25 + 12 x M12/M20

Ensto Cubo D enclosures are dimensioned according to the 'European Norm' sizes. The Cubo D has plain sides and is available as standard in RAL7035 and in the following variants.

Polycarbonate with Grey Lid  
 Polycarbonate with Transparent Lid  
 ABS with Grey Lid  
 ABS with Polycarbonate Transparent Lid

Polycarbonate  
 Operating Temperature -50°C to +100°C and UV stabilised. Flammability UL746C:5V. IP66/67. IK08  
 Standards: EN 62208, UL 508A, GOST.

ABS  
 Operating Temperature -40°C to +60°C. Flammability UL94: HB. IP66/67. IK07.



DABP162409T

**IP66/67 RAL7035**  
 Ensto Cubo D OEM Enclosures  
 ABS with Polycarbonate Transparent Lid

REF NO	Dimensions (mm) W x H x D	Internal Depth (mm)	PRICE
DABP050504T	53 x 55 x 36	27.5	6.77
DABP050704T	53 x 63 x 36	25	8.42
DABP080806T	80 x 82 x 56	42	11.19
DABP080809T	80 x 82 x 86	72	12.00
DABP081206T	80 x 120 x 56	42	12.29
DABP081209T	80 x 120 x 86	72	13.55
DABP081606T	80 x 160 x 56	42	14.00
DABP081609T	80 x 160 x 86	72	15.65
DABP121206T	120 x 122 x 56	42	14.94
DABP121209T	120 x 122 x 86	72	16.52
DABP121609T	120 x 160 x 91	77.5	19.13
DABP122009T	120 x 200 x 86	72	19.23
DABP152008T	150 x 200 x 76	62	22.39
DABP162409T	160 x 240 x 91	77.5	27.29
DABP162412T	160 x 240 x 121	107.5	31.65
DABP233009T	230 x 300 x 86	72.5	44.23
DABP233011T	230 x 300 x 111	97.5	49.45



DABP081206G

**IP66/67 RAL7035**  
 Ensto Cubo D OEM Enclosures  
 ABS with Grey Lid

REF NO	Dimensions (mm) W x H x D	Internal Depth (mm)	PRICE
DABP050504G	53 x 55 x 36	27.5	6.81
DABP050704G	53 x 63 x 36	25	8.52
DABP080806G	80 x 82 x 56	42	11.23
DABP080809G	80 x 82 x 86	72	12.06
DABP081206G	80 x 120 x 56	42	12.39
DABP081209G	80 x 120 x 86	72	13.61
DABP081606G	80 x 160 x 56	42	14.06
DABP081609G	80 x 160 x 86	72	15.74
DABP121206G	120 x 122 x 56	42	15.00
DABP121209G	120 x 122 x 86	72	16.61
DABP121609G	120 x 160 x 91	77.5	19.23
DABP122009G	120 x 200 x 86	72	19.35
DABP152008G	150 x 200 x 76	62	22.48
DABP162409G	160 x 240 x 91	77.5	27.52
DABP162412G	160 x 240 x 121	107.5	31.84
DABP233009G	230 x 300 x 86	72.5	44.52
DABP233011G	230 x 300 x 111	97.5	49.74

A useful feature of the Cubo D lid are the internal fixing pods. Slots in the base of the enclosure are also convenient for locating circuit boards.

**IP66/67 RAL7035**  
 Ensto Cubo D OEM Enclosures  
 Polycarbonate with Grey Lid

REF NO	Dimensions (mm) W x H x D	Internal Depth (mm)	PRICE
DPCP050504G	53 x 55 x 36	27.5	7.39
DPCP050704G	53 x 63 x 36	25	9.19
DPCP080806G	80 x 82 x 56	42	12.65
DPCP080809G	80 x 82 x 86	72	14.03
DPCP081206G	80 x 120 x 56	42	13.81
DPCP081209G	80 x 120 x 86	72	15.65
DPCP081606G	80 x 160 x 56	42	16.03
DPCP081609G	80 x 160 x 86	72	20.03
DPCP121206G	120 x 122 x 56	42	17.35
DPCP121209G	120 x 122 x 86	72	19.48
DPCP121609G	120 x 160 x 91	77.5	24.19
DPCP122009G	120 x 200 x 86	72	24.90
DPCP152008G	150 x 200 x 76	62	27.74
DPCP162409G	160 x 240 x 91	77.5	31.23
DPCP162412G	160 x 240 x 121	107.5	38.58
DPCP233009G	230 x 300 x 86	72.5	51.61
DPCP233011G	230 x 300 x 111	97.5	60.48

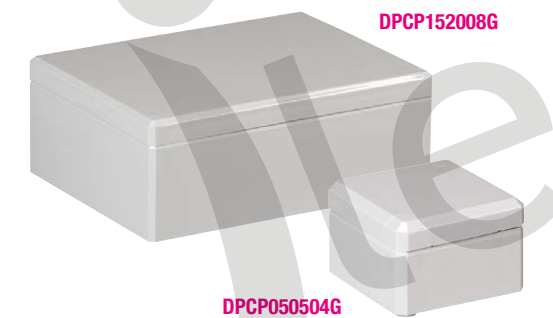

DPCP152008G

DPCP050504G

**Ensto Cubo D Steel Mounting Plates**

The Ensto Cubo D mounting plates are made from 1.5mm thick galvanised steel.

REF NO	Plate Size (mm)		Enclosures Size (mm)		PRICE
	W	H	W	H	
DMP0808	55	65	80	82	2.71
DMP0812	65	93	80	120	2.71
DMP0816	65	133	80	160	2.58
DMP1212	95	105	120	122	2.48
DMP1216	105	132	120	160	3.13
DMP1220	105	172	120	200	4.10
DMP1520	133	172	150	200	3.87
DMP1624	145	213	160	240	4.52
DMP2330	210	285	230	300	7.35

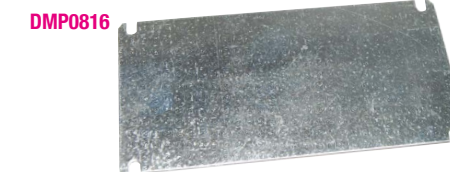

DMP0816

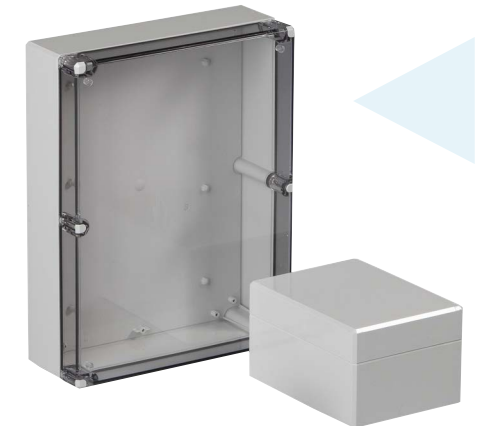

**IP66/67 RAL7035**  
 Ensto Cubo D OEM Enclosures  
 Polycarbonate with Transparent Lid

REF NO	Dimensions (mm) W x H x D	Internal Depth (mm)	PRICE
DPCP050504T	53 x 55 x 36	27.5	7.45
DPCP050704T	53 x 63 x 36	25	9.26
DPCP080806T	80 x 82 x 56	42	12.77
DPCP080809T	80 x 82 x 86	72	14.16
DPCP081206T	80 x 120 x 56	42	13.97
DPCP081209T	80 x 120 x 86	72	15.81
DPCP081606T	80 x 160 x 56	42	16.16
DPCP081609T	80 x 160 x 86	72	18.23
DPCP121206T	120 x 122 x 56	42	17.52
DPCP121209T	120 x 122 x 86	72	19.68
DPCP121609T	120 x 160 x 91	77.5	24.42
DPCP122009T	120 x 200 x 86	72	25.16
DPCP152008T	150 x 200 x 76	62	27.97
DPCP162409T	160 x 240 x 91	77.5	31.55
DPCP162412T	160 x 240 x 121	107.5	39.03
DPCP233009T	230 x 300 x 86	72.5	52.16
DPCP233011T	230 x 300 x 111	97.5	61.10



DSHI-1

DFL-1

**Ensto Cubo D Accessories**

REF NO	Description	PRICE
DSHI-1	Pair of external hinges for use on 80mm x 82mm enclosures or larger	7.48
DFL-1	Set of 4 wall fastening lugs	2.71

Ensto Cubo O is a range of medium sized enclosures in standard RAL7035. The dimensions are in increments of 100mm starting with the smallest at 200 x 200mm to the largest at 400 x 600mm. They come in two depths of 132mm and 185mm. The 185mm deep enclosures include a 55mm deep extension frame. Additional frames may be used to create a deeper enclosure whilst retaining the IP66/67 rating. They are available in the following variants:

- Polycarbonate with Grey Lid
- Polycarbonate with Transparent Lid
- ABS with Grey Lid
- ABS with Polycarbonate Transparent Lid

**Polycarbonate**  
Operating Temperature -50°C to +100°C and UV stabilised. Flammability UL746C:5V. IP66/67. IK08.

**ABS**  
Operating Temperature -40°C to +60°C. Flammability UL94: HB. IP66/67. IK07.



OABP203013T

**IP66/67 RAL7035**  
Ensto Cubo O Electrical Enclosures  
ABS with Transparent Lid

REF NO	Dimensions (mm) W x H x D	Internal Depth (mm)	PRICE
OABP202013T	200 x 200 x 132	115	33.29
OABP203013T	200 x 300 x 132	115	44.68
OABP204013T	200 x 400 x 132	115	52.06
OABP303013T	300 x 300 x 132	115	55.10
OABP304013T	300 x 400 x 132	115	65.68
OABP404013T	400 x 400 x 132	115	88.71
OABP306013T	300 x 600 x 132	115	106.19
OABP406013T	400 x 600 x 132	115	134.94
OABP202018T	200 x 200 x 185	170	62.97
OABP203018T	200 x 300 x 185	170	65.81
OABP204018T	200 x 400 x 185	170	73.26
OABP303018T	300 x 300 x 185	170	89.48
OABP304018T	300 x 400 x 185	170	101.71
OABP404018T	400 x 400 x 185	170	137.35
OABP306018T	300 x 600 x 185	170	146.32
OABP406018T	400 x 600 x 185	170	171.16

**Ensto Cubo O / Cubo C Accessories**

REF NO	Description	PRICE
OEL-1	Corner elevator which permits the mounting plate to be placed at various depths 4 required on sizes up to 400 x 400mm 6 required on 600 x 300mm & 600 x 400mm	1.45
OLW55	Wing headed screw	0.42
OFL-1	Set of four wall mounting lugs	2.26
OHI-1	Pair of hinges	7.48
WQL1.1	Pair of latches	10.55
OCP1	Corner cover plug	0.23

**IP66/67 RAL7035**  
Ensto Cubo O Electrical Enclosures  
ABS with Grey Lid

REF NO	Dimensions (mm) W x H x D	Internal Depth (mm)	PRICE
OABP202013G	200 x 200 x 132	115	29.19
OABP203013G	200 x 300 x 132	115	40.48
OABP204013G	200 x 400 x 132	115	45.29
OABP303013G	300 x 300 x 132	115	49.23
OABP304013G	300 x 400 x 132	115	56.45
OABP404013G	400 x 400 x 132	115	76.23
OABP306013G	300 x 600 x 132	115	97.61
OABP406013G	400 x 600 x 132	115	123.58
OABP202018G	200 x 200 x 185	170	48.97
OABP203018G	200 x 300 x 185	170	61.68
OABP204018G	200 x 400 x 185	170	73.29
OABP303018G	300 x 300 x 185	170	77.16
OABP304018G	300 x 400 x 185	170	81.39
OABP404018G	400 x 400 x 185	170	109.87
OABP306018G	300 x 600 x 185	170	142.77
OABP406018G	400 x 600 x 185	170	159.35

**IP66/67 RAL7035**  
Ensto Cubo O Electrical Enclosures  
Polycarbonate with Grey Lid

REF NO	Dimensions (mm) W x H x D	Internal Depth (mm)	PRICE
OPCP202013G	200 x 200 x 132	115	45.16
OPCP203013G	200 x 300 x 132	115	58.45
OPCP204013G	200 x 400 x 132	115	72.16
OPCP303013G	300 x 300 x 132	115	74.94
OPCP304013G	300 x 400 x 132	115	89.48
OPCP404013G	400 x 400 x 132	115	120.81
OPCP306013G	300 x 600 x 132	115	134.81
OPCP406013G	400 x 600 x 132	115	169.87
OPCP202018G	200 x 200 x 185	170	63.45
OPCP203018G	200 x 300 x 185	170	78.55
OPCP204018G	200 x 400 x 185	170	106.13
OPCP303018G	300 x 300 x 185	170	97.65
OPCP304018G	300 x 400 x 185	170	115.26
OPCP404018G	400 x 400 x 185	170	155.65
OPCP306018G	300 x 600 x 185	170	173.29
OPCP406018G	400 x 600 x 185	170	207.39

OPCP404013G



OPCP303018T

**IP66/67 RAL7035**  
Ensto Cubo O Electrical Enclosures  
Polycarbonate with Transparent Lid

REF NO	Dimensions (mm) W x H x D	Internal Depth (mm)	PRICE
OPCP202013T	200 x 200 x 132	115	45.16
OPCP203013T	200 x 300 x 132	115	58.45
OPCP204013T	200 x 400 x 132	115	72.16
OPCP303013T	300 x 300 x 132	115	74.94
OPCP304013T	300 x 400 x 132	115	89.48
OPCP404013T	400 x 400 x 132	115	120.81
OPCP306013T	300 x 600 x 132	115	134.81
OPCP406013T	400 x 600 x 132	115	169.87
OPCP202018T	200 x 200 x 185	170	63.45
OPCP203018T	200 x 300 x 185	170	78.55
OPCP204018T	200 x 400 x 185	170	106.13
OPCP303018T	300 x 300 x 185	170	97.65
OPCP304018T	300 x 400 x 185	170	115.26
OPCP404018T	400 x 400 x 185	170	155.65
OPCP306018T	300 x 600 x 185	170	173.29
OPCP406018T	400 x 600 x 185	170	207.39

**Ensto Cubo O Steel Mounting Plates**

The Ensto Cubo O mounting plates are made from 1.5mm thick galvanised steel.

REF NO	Plate Size (mm)			Enclosures Size (mm)			PRICE
	W	x	H	W	x	H	
OMP2020	160	x	160	200	x	200	5.48
OMP2030	160	x	260	200	x	300	7.16
OMP2040	160	x	360	200	x	400	10.84
OMP3030	260	x	260	300	x	300	9.61
OMP3040	260	x	360	300	x	400	10.69
OMP4040	360	x	360	400	x	400	15.35
OMP3060	260	x	560	300	x	600	16.61
OMP4060	360	x	560	400	x	600	24.89



**Ensto Cubo O Extension Frames**

The depth extension is designed to give the enclosure greater depth. Each extension adds 55mm to the depth of the enclosure and is supplied complete with fixing screws. The IP rating is maintained when fitted.

REF NO	Dimensions (mm)			PRICE
	W	x	H x D	
OPCP202006E	200	x	200 x 55	17.97
OPCP203006E	200	x	300 x 55	21.16
OPCP204006E	200	x	400 x 55	23.90
OPCP303006E	300	x	300 x 55	23.13
OPCP304006E	300	x	400 x 55	26.55
OPCP404006E	400	x	400 x 55	35.84
OPCP306006E	300	x	600 x 55	37.68
OPCP406006E	400	x	600 x 55	39.45

OPCP203006E



The Ensto Cubo W is the hinged version of the Cubo O and features padlockable latches. The Cubo W is a range of medium sized enclosures in standard RAL 7035. The dimensions are in increments of 100mm starting with the smallest at 200 x 200mm to the largest at 400 x 600mm. They come in two depths of 132mm and 185mm. The 185mm deep enclosures include a 55mm deep extension frame. Additional frames may be used to create a deeper enclosure whilst retaining the IP66/67 rating.

Polycarbonate with Grey Lid  
 Polycarbonate with Transparent Lid  
 Standards: EN 62208, UL 508A, GOST

Polycarbonate  
 Operating Temperature -50°C to +100°C and UV stabilised. Flammability UL746C:5V. IP66/67. IK08

**IP66/67 RAL7035**  
 Ensto Cubo W Electrical Enclosures with Hinges  
 Polycarbonate with Transparent Lid

REF NO	Dimensions (mm) W x H x D	Internal Depth (mm)	PRICE
WPCP202013T	200 x 200 x 132	115	84.77
WPCP203013T	200 x 300 x 132	115	98.42
WPCP204013T	200 x 400 x 132	115	113.13
WPCP303013T	300 x 300 x 132	115	114.48
WPCP304013T	300 x 400 x 132	115	128.61
WPCP404013T	400 x 400 x 132	115	173.61
WPCP306013T	300 x 600 x 132	115	203.87
WPCP406013T	400 x 600 x 132	115	243.03
WPCP202018T	200 x 200 x 185	170	104.16
WPCP203018T	200 x 300 x 185	170	115.65
WPCP204018T	200 x 400 x 185	170	132.84
WPCP303018T	300 x 300 x 185	170	131.52
WPCP304018T	300 x 400 x 185	170	149.48
WPCP404018T	400 x 400 x 185	170	205.84
WPCP306018T	300 x 600 x 185	170	236.84
WPCP406018T	400 x 600 x 185	170	271.84



WPCP203013G



WPCP304018T

**IP66/67 RAL7035**  
 Ensto Cubo W Electrical Enclosures with Hinges  
 Polycarbonate with Grey Lid

REF NO	Dimensions (mm) W x H x D	Internal Depth (mm)	PRICE
WPCP202013G	200 x 200 x 132	115	83.97
WPCP203013G	200 x 300 x 132	115	96.23
WPCP204013G	200 x 400 x 132	115	112.19
WPCP303013G	300 x 300 x 132	115	114.84
WPCP304013G	300 x 400 x 132	115	126.68
WPCP404013G	400 x 400 x 132	115	170.97
WPCP306013G	300 x 600 x 132	115	206.06
WPCP406013G	400 x 600 x 132	115	237.65
WPCP202018G	200 x 200 x 185	170	100.43
WPCP203018G	200 x 300 x 185	170	119.26
WPCP204018G	200 x 400 x 185	170	131.90
WPCP303018G	300 x 300 x 185	170	136.68
WPCP304018G	300 x 400 x 185	170	154.03
WPCP404018G	400 x 400 x 185	170	207.94
WPCP306018G	300 x 600 x 185	170	258.35
WPCP406018G	400 x 600 x 185	170	275.42



OMP3030

**Ensto Cubo O/C/W Steel Mounting Plates**

The Ensto Cubo O mounting plates are made from 1.5mm thick galvanised steel.

REF NO	Plate Size (mm) W x H	Enclosures Size (mm) W x H	PRICE
OMP2020	160 x 160	200 x 200	5.61
OMP2030	160 x 260	200 x 300	7.29
OMP2040	160 x 360	200 x 400	10.89
OMP3030	260 x 260	300 x 300	9.95
OMP3040	260 x 360	300 x 400	10.69
OMP4040	360 x 360	400 x 400	15.22
OMP3060	260 x 560	300 x 600	17.20
OMP4060	360 x 560	400 x 600	24.58

**Ensto Cubo W Accessories**

REF NO	Description	PRICE
OEL1	Corner elevator which permits the mounting plate to be placed at various depths 4 required on sizes up to 400 x 400mm 6 required on 600 x 300mm & 600 x 400mm	1.45
OFL1	Set of four wall mounting lugs	2.26



OFL1

OEL1

**Ensto Cubo O Fixed Aluminium Front Panel**

There are two types of front panel - fixed or hinged. Both types come with a corner elevator so the panel may be fixed at the required depth.

REF NO	Plate Size (mm) W x H	Enclosures Size (mm) W x H	PRICE
OFFP22A	186 x 186	200 x 200	POA
OFFP23A	186 x 286	200 x 300	POA
OFFP24A	186 x 386	200 x 400	POA
OFFP33A	286 x 286	300 x 300	POA
OFFP34A	286 x 386	300 x 400	POA
OFFP44A	386 x 386	400 x 400	POA
OFFP36A	286 x 586	300 x 600	POA
OFFP46A	386 x 586	400 x 600	POA



**Ensto Cubo O Hinged Aluminium Front Panel**

There are two types of front panel - fixed or hinged. Both types come with a corner elevator so the panel may be fixed at the required depth.

REF NO	Dimensions (mm) W x H	Hinge Side	PRICE
OHFP22A	186 x 186	200mm side	POA
OHFP23A	186 x 286	200mm side	POA
OHFP32A	286 x 186	300mm side	POA
OHFP24A	186 x 386	200mm side	POA
OHFP42A	386 x 186	400mm side	POA
OHFP33A	286 x 286	300mm side	POA
OHFP34A	286 x 386	300mm side	POA
OHFP36A	286 x 586	300mm side	POA
OHFP43A	386 x 286	400mm side	POA
OHFP44A	386 x 386	400mm side	POA
OHFP46A	386 x 586	400mm side	POA
OHFP63A	586 x 286	600mm side	POA
OHFP64A	586 x 386	600mm side	POA

The PolyBox is the latest release from Ensto. It is a rugged industrial polycarbonate enclosure with some unique features.

- IP66, IP68, IP69K, UL4X & 6P
- IK10 Impact Resistance
- Conforms to EN62208 & UL508A
- Hydrophobic Gasket
- Adjustable Feet & Flanges
- 4 Size Options from 223H x 172W x 139D to 482H x 431W x 291D (External dimensions)
- Clear or Grey Lid
- Integral hinges and latches on some versions
- Operating Temperature -40°C to +80°C with short term to 120°C and UV stabilised
- Flammability UL746C:5V
- Rated Voltage 1000 - 1500V



**IP66/68/69K RAL7035**  
Ensto PolyBox Electrical Enclosures - Grey Lid

REF NO	Dimensions (mm) H x W x D	Internal Depth (mm)	PRICE
<b>Hinged Grey Lid with Plastic Snap Latches</b>			
UPCG080604HNL	223 x 172 x 139	105	58.11
UPCG100806HNL	276 x 225 x 190	156	72.73
UPCG121006HNL	326 x 276 x 190	156	84.29
UPCG181610HNL	482 x 431 x 291	257	143.38

REF NO	Dimensions (mm) H x W x D	Internal Depth (mm)	PRICE
<b>Hinged Grey Lid with Metal Snap Latches</b>			
UPCG080604HML	223 x 172 x 139	105	69.45
UPCG100806HML	276 x 225 x 190	156	93.40
UPCG121006HML	326 x 276 x 190	156	106.45
UPCG181610HML	482 x 431 x 291	257	175.80



**Ensto PolyBox Aluminium Hinged Front Plates**

REF NO	Plate Size (mm) W x H	Enclosures Size (mm) W x H	PRICE
<b>Aluminium Hinged Front Plates complete with Elevators &amp; Hinges</b>			
UHFK0806A	171 x 120	223 x 172	21.84
UHFK1008A	222 x 171	276 x 225	26.93
UHFK1210A	272 x 222	326 x 276	34.15
UHFK1816A	425 x 374	482 x 431	67.64

**IP66/68/69K RAL7035**  
Ensto PolyBox Electrical Enclosures - Grey Lid

REF NO	Dimensions (mm) H x W x D	Internal Depth (mm)	PRICE
<b>Screw Down Grey Lid</b>			
UPCG080604	223 x 172 x 139	105	63.29
UPCG100806	276 x 225 x 190	156	77.07
UPCG121006	326 x 276 x 190	156	87.67
UPCG181610	482 x 431 x 291	257	158.67

REF NO	Dimensions (mm) H x W x D	Internal Depth (mm)	PRICE
<b>Padlockable Grey Hinged Lid</b>			
UPCG080604HS	223 x 172 x 139	105	61.64
UPCG100806HS	276 x 225 x 190	156	76.38
UPCG121006HS	326 x 276 x 190	156	86.55
UPCG181610HS	482 x 431 x 291	257	155.87



**IP66/68/69K RAL7035**  
Ensto PolyBox Electrical Enclosures - Transparent Lid

REF NO	Dimensions (mm) H x W x D	Internal Depth (mm)	PRICE
<b>Screw Down Transparent Lid</b>			
UPCT080604	223 x 172 x 139	105	63.15
UPCT100806	276 x 225 x 190	156	77.22
UPCT121006	326 x 276 x 190	156	87.56
UPCT181610	482 x 431 x 291	257	163.31

REF NO	Dimensions (mm) H x W x D	Internal Depth (mm)	PRICE
<b>Padlockable Transparent Hinged Lid</b>			
UPCT080604HS	223 x 172 x 139	105	61.16
UPCT100806HS	276 x 225 x 190	156	74.45
UPCT121006HS	326 x 276 x 190	156	84.98
UPCT181610HS	482 x 431 x 291	257	153.35



**IP66/68/69K RAL7035**  
Ensto PolyBox Electrical Enclosures - Transparent Lid

REF NO	Dimensions (mm) H x W x D	Internal Depth (mm)	PRICE
<b>Hinged Transparent Lid with Plastic Snap Latches</b>			
UPCT080604HNL	223 x 172 x 139	105	57.60
UPCT100806HNL	276 x 225 x 190	156	72.15
UPCT121006HNL	326 x 276 x 190	156	82.87
UPCT181610HNL	482 x 431 x 291	257	141.15

REF NO	Dimensions (mm) H x W x D	Internal Depth (mm)	PRICE
<b>Hinged Transparent Lid with Metal Snap Latches</b>			
UPCT080604HML	223 x 172 x 139	105	70.20
UPCT100806HML	276 x 225 x 190	156	95.51
UPCT121006HML	326 x 276 x 190	156	106.31
UPCT181610HML	482 x 431 x 291	257	177.44



**Ensto PolyBox Mounting Plates**

REF NO	Plate Size (mm) W x H	Enclosures Size (mm) W x H	PRICE
<b>Galvanised Steel Mounting Plates</b>			
UBP0806Z	171 x 120	223 x 172	5.49
UBP1008Z	222 x 171	276 x 225	9.05
UBP1210Z	272 x 222	326 x 276	13.78
UBP1816Z	425 x 374	482 x 431	37.71

REF NO	Plate Size (mm) W x H	Enclosures Size (mm) W x H	PRICE
<b>White Painted Steel Mounting Plates</b>			
UBP0806ZW	171 x 120	223 x 172	13.65
UBP1008ZW	222 x 171	276 x 225	17.65
UBP1210ZW	272 x 222	326 x 276	26.67
UBP1816ZW	425 x 374	482 x 431	50.16



**Accessories**

REF NO	Description	PRICE
UMF06.02	Set of 2 Mounting Flanges for UPC080604 Size	6.18
UMF08.02	Set of 2 Mounting Flanges for UPC100806 Size	6.85
UMF10.02	Set of 2 Mounting Flanges for UPC121006 Size	8.05
UMF16.02	Set of 2 Mounting Flanges for UPC181610 Size	10.96
UMB1.04	Set of 4 Mounting feet suitable for all sizes	4.38
UEL1.04S	Set of 4 Corner Elevators with fixing screws	10.67
UHFP1.04	Front Panel Hinge Kit only comprising of 2 Hinges and 2 Elevators. Can be used to convert Steel Mounting Plates to Front Plates	13.87

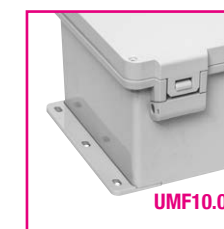

The PolyBox is supplied with a set of 4 Mounting Feet as standard. Mounting flanges, if desired, can be ordered separately.

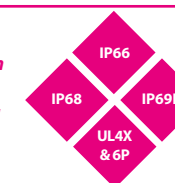

# Fibox Piccolo Terminal Boxes

The Fibox Piccolo enclosure offers a range of six base sizes and two different depths in four of those sizes. An excellent rugged enclosure which lends itself as a superb terminal box. Standard colour is RAL7035.

Available as:

- ABS with Grey Lid
- Polycarbonate with Grey Lid
- Polycarbonate with Transparent Lid



## IP66/67 RAL7035

### Fibox Piccolo Enclosures - ABS with Grey Lid

REF NO	Dimensions (mm)			Internal Depth (mm)	PRICE
	H	x	W x D		
ABSB65G	110	x	80 x 65	52	8.10
ABSB85G	110	x	80 x 85	72	9.09
ABSC65G	140	x	80 x 65	52	8.98
ABSC85G	140	x	80 x 85	72	10.34
ABSD65G	170	x	80 x 65	52	9.92
ABSD85G	170	x	80 x 85	72	11.41
ABSF65G	230	x	80 x 65	52	11.35
ABSF85G	230	x	80 x 85	72	12.82
ABSH95G	170	x	140 x 95	81.7	14.75
ABSM95G	230	x	140 x 95	81.7	17.81
ABSMH125G	230	x	140 x 125	111.7	21.09

### Fibox Piccolo Mounting Plates

REF NO	Dimensions (mm)		To Suit Enclosure	PRICE
	W	x H		
B-MP	80	x 54	ABSB**/PCB**	1.65
C-MP	110	x 54	ABSC**/PCC**	2.06
D-MP	140	x 54	ABSD**/PCD**	2.66
F-MP	200	x 54	ABSF**/PCF**	3.95
H-MP	125	x 94	ABSH**/PCH**	5.39
M-MP	185	x 94	ABSM**/PCM**	7.00



### Fibox Piccolo Accessories

REF NO	Description	PRICE
PA22039	Pair of hinges for Piccolo enclosures	3.47
FP22046	Set of four mounting feet	1.43

## IP66/67 RAL7035

### Fibox Piccolo Enclosures - Polycarbonate with Grey Lid

REF NO	Dimensions (mm)			Internal Depth (mm)	PRICE
	H	x	W x D		
PCB65G	110	x	80 x 65	52	14.29
PCB85G	110	x	80 x 85	72	15.99
PCC65G	140	x	80 x 65	52	15.33
PCC85G	140	x	80 x 85	72	16.96
PCD65G	170	x	80 x 65	52	16.40
PCD85G	170	x	80 x 85	72	18.55
PCF65G	230	x	80 x 65	52	19.23
PCF85G	230	x	80 x 85	72	21.81
PCH95G	170	x	140 x 95	81.7	24.23
PCM95G	230	x	140 x 95	81.7	28.25
PCMH125G	230	x	140 x 125	111.7	32.21

## IP66/67 RAL7035

### Fibox Piccolo Enclosures Polycarbonate with Transparent Lid

REF NO	Dimensions (mm)			Internal Depth (mm)	PRICE
	H	x	W x D		
PCB65T	110	x	80 x 65	52	14.39
PCB85T	110	x	80 x 85	72	16.12
PCC65T	140	x	80 x 65	52	15.44
PCC85T	140	x	80 x 85	72	17.13
PCD65T	170	x	80 x 65	52	16.49
PCD85T	170	x	80 x 85	72	18.72
PCF65T	230	x	80 x 65	52	19.36
PCF85T	230	x	80 x 85	72	22.01
PCH95T	170	x	140 x 95	81.7	24.41
PCM95T	230	x	140 x 95	81.7	28.38
PCMH125T	230	x	140 x 125	111.7	33.03



## IP65 RAL7035

### Fibox Tempo Enclosures with Internal Hinges Transparent Lid

REF NO	Dimensions (mm)			Internal Depth (mm)	PRICE
	H	x	W x D		
TA191209T	187	x	122 x 90	75	8.57
TA201610T	201	x	163 x 98	83	12.14
TA241911T	240	x	191 x 107	92	12.75
TA292411T	289	x	239 x 107	92	23.11
TA342912T	344	x	289 x 117	102	35.92

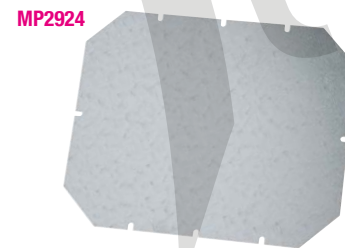

### Fibox Tempo Mounting Plates

The Fibox Tempo Enclosure mounting plates are made from 1.5mm thick galvanised steel

REF NO	Plate Size (mm)		Enclosures Size (mm)		PRICE
	H	x W	H	x W	
MP1912	140	x 100	187	x 122	2.51
MP2016	165	x 140	201	x 163	2.76
MP2419	210	x 160	240	x 191	4.37
MP2924	265	x 215	289	x 239	8.33
MP3429	315	x 265	344	x 289	11.09
FP10674	Wall Fixings				2.03

# Fibox Tempo ABS Enclosures

The Fibox Tempo range is made from ABS and are available with either a grey or transparent lid.

The enclosures have a protection rating of IP65 IK07, are halogen-free and RoHS compliant.

Glow wire test 650°C self-extinguishing according to IEC 695-2-1



## IP65 RAL7035

### Fibox Tempo Enclosures with Internal Hinges Grey Lid

REF NO	Dimensions (mm)			Internal Depth (mm)	PRICE
	H	x	W x D		
TA090706	95	x	65 x 60	48	7.17
TA111107	110	x	110 x 65	53	7.77
TA131007	130	x	95 x 65	53	7.96
TA131308	130	x	130 x 75	63	8.28
TA191209	187	x	122 x 90	75	7.79
TA201610	201	x	163 x 98	83	11.05
TA241911	240	x	191 x 107	92	11.59
TA292411	289	x	239 x 107	92	21.00
TA342912	344	x	289 x 117	102	32.66

## Breakers & Accessories

See our full range on pages 202-221

Or call us to discuss your requirements



The Fibox MNX enclosure is ideal for housing electrical and electronic components. The lid features a recess which is ideal for membrane keypads. The enclosures have a protection rating of IP66/67 and comply with EN60529.

Available as:

- Polycarbonate with Grey Lid
- Polycarbonate with Transparent Lid

PC125/35LG



**IP66/67 RAL7035**  
Fibox MNX Enclosures  
Polycarbonate with Grey Lid

REF NO	Dimensions (mm)			Internal Depth (mm)	PRICE
	W	x	H x D		
PC95/35LG	100	x	100 x 35	28.8	10.23
PC95/50LG	100	x	100 x 50	45.6	10.35
PC95/60HG	100	x	100 x 60	53.8	11.15
PC95/75HG	100	x	100 x 75	70.6	11.30
PC100/35LG	130	x	80 x 35	29.3	12.21
PC100/50LG	130	x	80 x 50	45.6	11.72
PC100/60HG	130	x	80 x 60	53.8	12.71
PC100/75HG	130	x	80 x 75	70.6	12.36
PC100/100LG	130	x	80 x 100	95.4	12.96
PC100/100HG	130	x	80 x 100	95.4	12.96
PC100/125HG	130	x	80 x 125	120.4	13.49
PC125/35LG	130	x	130 x 35	28.8	14.56
PC125/50LG	130	x	130 x 50	45.6	14.81
PC125/60HG	130	x	130 x 60	53.8	14.99
PC125/75HG	130	x	130 x 75	70.6	15.39
PC125/100LG	130	x	130 x 100	95.4	15.72
PC125/100HG	130	x	130 x 100	95.4	15.72
PC125/125HG	130	x	130 x 125	120.4	16.14

**IP66/67 RAL7035**

Fibox MNX Enclosures  
Polycarbonate with Grey Lid

REF NO	Dimensions (mm)			Internal Depth (mm)	PRICE
	W	x	H x D		
PC150/35LG	180	x	130 x 35	28.5	17.57
PC150/50LG	180	x	130 x 50	45.4	17.87
PC150/60HG	180	x	130 x 60	53.5	18.04
PC150/75HG	180	x	130 x 75	70.4	18.22
PC150/85XHG	180	x	130 x 85	78.5	23.24
PC150/100HG	180	x	130 x 100	95.1	18.67
PC150/100XHG	180	x	130 x 100	95.4	24.29
PC150/125LG	180	x	130 x 125	119.6	23.16
PC150/125HG	180	x	130 x 125	119.7	19.20
PC150/150HG	180	x	130 x 150	144.6	23.85
PC175/60HG	180	x	180 x 60	53.5	22.95
PC175/75HG	180	x	180 x 75	70.1	22.62
PC175/100HG	180	x	180 x 100	95.3	23.65
PC175/125HG	180	x	180 x 125	120.2	29.53
PC175/150HG	180	x	180 x 150	145.1	31.29
PC200/63HG	255	x	180 x 63	55	47.54
PC200/75HG	255	x	180 x 75	70.4	40.45
PC200/88XHG	255	x	180 x 88	79	50.46
PC200/100HG	255	x	180 x 100	95	40.45
PC200/100XHG	255	x	180 x 100	94.4	41.92
PC200/125XHG	255	x	180 x 125	119	42.04
PC200/150HG	255	x	180 x 150	141	41.72
PC200/175XHG	255	x	180 x 175	168.4	43.69
PC300/150ZG	360	x	255 x 152	143	81.62

MIV175



**Fibox MNX Mounting Plates**

The Fibox MNX mounting plates are made from 1.5mm thick galvanised steel.

REF NO	Plate Size (mm)		Enclosures Size (mm)		PRICE	
	W	x	W	x		
MIV95	66	x	100	x	100	1.29
MIV100	98	x	130	x	80	1.52
MIV125	98	x	130	x	130	1.89
MIV150	148	x	180	x	130	2.21
MIV175	148	x	180	x	180	2.66
MIV200	223	x	255	x	180	3.56
MIV300	330	x	360	x	255	7.55



PC100/60HT

**IP66/67 RAL7035**

Fibox MNX Enclosures  
Polycarbonate with Smoked Transparent Lid

REF NO	Dimensions (mm)			Internal Depth (mm)	PRICE
	W	x	H x D		
PC95/35LT	100	x	100 x 35	28.8	10.35
PC95/50LT	100	x	100 x 50	45.6	10.73
PC100/35LT	130	x	80 x 35	29.3	12.32
PC100/50LT	130	x	80 x 50	45.6	12.24
PC100/60HT	130	x	80 x 60	53.8	12.80
PC100/75HT	130	x	80 x 75	70.6	13.09
PC125/35LT	130	x	130 x 35	28.8	14.35
PC125/60HT	130	x	130 x 60	53.8	15.32
PC125/75HT	130	x	130 x 75	70.6	18.10
PC125/100HT	130	x	130 x 100	95.4	15.86
PC125/125HT	130	x	130 x 125	120.4	16.43
PC150/35LT	180	x	130 x 35	28.5	17.64
PC150/50LT	180	x	130 x 50	45.4	17.94
PC150/60HT	180	x	130 x 60	53.5	18.04
PC150/75HT	180	x	130 x 75	70.4	18.28
PC150/85XHT	180	x	130 x 85	78.5	23.20
PC150/100HT	180	x	130 x 100	95.1	18.78
PC150/100XHT	180	x	130 x 100	95.4	24.20
PC150/125HT	180	x	130 x 125	119.7	19.44
PC150/150HT	180	x	130 x 150	144.6	24.23
PC175/60HT	180	x	180 x 60	53.5	23.16
PC175/75HT	180	x	180 x 75	70.1	23.13
PC175/125HT	180	x	180 x 125	120.2	30.42
PC175/150HT	180	x	180 x 150	145.1	32.17

**IP66/67 RAL7035**

Fibox MNX Enclosures  
Polycarbonate with Smoked Transparent Lid

REF NO	Dimensions (mm)			Internal Depth (mm)	PRICE
	W	x	H x D		
PC200/63HT	255	x	180 x 63	55	48.60
PC200/75HT	255	x	180 x 75	70.4	40.36
PC200/88XHT	255	x	180 x 88	79	51.52
PC200/100HT	255	x	180 x 100	95	41.10
PC200/125XHT	255	x	180 x 125	119	42.66
PC200/150HT	255	x	180 x 150	141	42.71
PC200/175XHT	255	x	180 x 175	168.4	44.77
PC300/150ZT	360	x	255 x 152	143	84.01



PC125/60HT

**Fibox MNX Accessories**

REF NO	Description	PRICE
THA	Pair of external hinges	5.24
FP22046	Set of four mounting feet	1.43



FP22046

THA

**Cables & Accessories**

See Pages 152-177



The Fibox Solid enclosure is available in seven base sizes and 2 different depths which are achieved by either a 30mm or 80mm lid. Also expandable in depth with the use of extension frames. All sizes and depths are available in polycarbonate or ABS. Available as:

**ABS with Grey Lid**  
**Polycarbonate with Grey Lid**  
**Polycarbonate with Transparent Lid**

**ABS: IP 66/67; IK 08; NEMA Type 1, 4, 4X, 6, 12 and 13; UL 94 HB.**

**Polycarbonate: IP 66/67; IK 08; NEMA Type 1, 3, 3S, 4, 4X, 6, 6P and 12; UL 746C 5V; UL 508.**

**IP66/67 RAL7035**  
**Fibox Solid Enclosures Polycarbonate with Grey Lid**

REF NO	Dimensions (mm)			Internal Depth (mm)	PRICE
	W	x	H x D		
PC191913G	190	x	190 x 130	115	45.30
PC281913G	280	x	190 x 130	115	58.84
PC381913G	380	x	190 x 130	115	72.49
PC282813G	280	x	280 x 130	115	76.25
PC382813G	380	x	280 x 130	115	91.71
PC562813G	560	x	280 x 130	115	128.15
PC191918G	190	x	190 x 180	165	50.70
PC281918G	280	x	190 x 180	165	66.22
PC381918G	380	x	190 x 180	165	81.87
PC282818G	280	x	280 x 180	165	85.28
PC382818G	380	x	280 x 180	165	103.03
PC563818G	560	x	380 x 180	165	171.28

**Fibox Solid Enclosure Mounting Plates**

The Fibox Solid mounting plates are made from 1.5mm thick galvanised steel

REF NO	Plate Size (mm)			Enclosures Size (mm)			PRICE
	W	x	H	W	x	H	
EKHVT	148	x	148	190	x	190	2.89
EKJVT	238	x	148	280	x	190	4.44
EKMVT	338	x	148	380	x	190	5.68
EKOVT	238	x	238	280	x	280	6.53
EKPVT	338	x	238	380	x	280	8.34
EKTVT	538	x	238	560	x	280	23.33
EKUVT	538	x	338	560	x	380	27.78



MB10564-II

**Fibox Solid Enclosure Accessories**

REF NO	Description	PRICE
MB10674	Set of four mounting feet	3.95
MB10564-II	Ventilator	8.25
DS10581	Triangle head cover screw	0.58
MB10622	Pair of external hinges for retro-fitting	3.33
FSH10740	Pair of high quality factory fitted hinges (Please state long or short side)	4.56



ABS281913G



PC381918T



EKMVT



L43-II

L12-II

**IP66/67 RAL7035**  
**Fibox Solid Enclosures ABS with Grey Lid**

REF NO	Dimensions (mm)			Internal Depth (mm)	PRICE
	W	x	H x D		
ABS191913G	190	x	190 x 130	115	29.75
ABS281913G	280	x	190 x 130	115	35.78
ABS381913G	380	x	190 x 130	115	45.65
ABS282813G	280	x	280 x 130	115	47.75
ABS382813G	380	x	280 x 130	115	57.73
ABS381918G	380	x	190 x 180	165	52.73
ABS282818G	280	x	280 x 180	165	50.72
ABS382818G	380	x	280 x 180	165	66.69

**IP66/67 RAL7035**  
**Fibox Solid Enclosures Polycarbonate with Transparent Lid**

REF NO	Dimensions (mm)			Internal Depth (mm)	PRICE
	W	x	H x D		
PC191913T	190	x	190 x 130	115	46.22
PC281913T	280	x	190 x 130	115	59.99
PC381913T	380	x	190 x 130	115	73.95
PC282813T	280	x	280 x 130	115	77.77
PC382813T	380	x	280 x 130	115	93.52
PC562813T	560	x	280 x 130	115	130.69
PC191918T	190	x	190 x 180	165	51.70
PC281918T	280	x	190 x 180	165	67.57
PC381918T	380	x	190 x 180	165	83.49
PC282818T	280	x	280 x 180	165	87.02
PC382818T	380	x	280 x 180	165	105.08
PC563818T	560	x	380 x 180	165	174.70

**Fibox Solid Enclosure Depth Extension Frames**

REF NO	Dimensions (mm)	Suitable for Enclosure	PRICE
	W x D x H		
EKJZR	280 x 190 x 50	PC/ABS2819	25.40
EKMZR	380 x 190 x 50	PC/ABS3819	28.53
EKOZR	280 x 280 x 50	PC/ABS2828	31.03
EKPZR	380 x 280 x 50	PC/ABS3828	33.67
EKTZR	560 x 280 x 50	PC/ABS5628	43.45
EKUZR	560 x 380 x 50	PC/ABS5638	40.09



EKPZR

**Fibox Inspection Windows - IP65**

The Fibox Inspection windows are made from Polycarbonate and when correctly fitted will maintain an Ingress rating of IP65.

REF NO	Dimensions (mm)			PRICE
	W	x	D x H	
L12-II	248	x	128 x 25	19.39
L24-II	248	x	218 x 25	24.12
L43-II	331	x	231 x 25	52.23
L44-II	377	x	331 x 25	56.87

See pages 180-182 for our full range of

**Distribution Blocks**



nvent ERIFLEX

FIBOX

FIBOX

The Fibox EK range is made from polycarbonate and comes complete with flange openings. It is available in seven base sizes with different depths. Also expandable in depth with the use of extension frames. Available as Polycarbonate with Grey Lid or Polycarbonate with Transparent Lid.

IP 66/67; IK 08/09; NEMA Type 1, 3, 3S, 4, 4X, 6, 6P, 12; UL 746C 5V; UL 508.



**IP66/67 RAL7035**  
Fibox EK Flange Enclosures  
Polycarbonate with Transparent Lid

REF NO	Dimensions (mm)			Internal Depth (mm)	PRICE
	W	x	H x D		
EKHA130T	190	x	190 x 130	115	38.34
EKJB130T	280	x	190 x 130	115	49.86
EKMB130T	380	x	190 x 130	115	61.76
EKOE130T	280	x	280 x 130	115	64.79
EKPE130T	380	x	280 x 130	115	78.05
EKTH130T	560	x	280 x 130	115	105.06
EKHA180T	190	x	190 x 180	165	43.44
EKJB180T	280	x	190 x 180	165	56.78
EKMB180T	380	x	190 x 180	165	70.53
EKOE180T	280	x	280 x 180	165	73.84
EKPE180T	380	x	280 x 180	165	88.60
EKUH180T	560	x	380 x 180	165	154.48
EKUM180T	560	x	380 x 180	165	154.48
EKUN180T	560	x	380 x 180	165	154.48



**IP66/67 RAL7035**  
Fibox EK Flange Enclosures  
Polycarbonate with Grey Lid

REF NO	Dimensions (mm)			Internal Depth (mm)	PRICE
	W	x	H x D		
EKHA130G	190	x	190 x 130	115	38.13
EKJB130G	280	x	190 x 130	115	49.56
EKMB130G	380	x	190 x 130	115	61.29
EKOE130G	280	x	280 x 130	115	64.39
EKPE130G	380	x	280 x 130	115	77.52
EKTH130G	560	x	280 x 130	115	110.18
EKHA180G	190	x	190 x 180	165	43.07
EKJB180G	280	x	190 x 180	165	56.34
EKMB180G	380	x	190 x 180	165	69.91
EKOE180G	280	x	280 x 180	165	73.28
EKPE180G	380	x	280 x 180	165	87.90
EKUM180G	560	x	380 x 180	165	153.49
EKUN180G	560	x	380 x 180	165	153.49
EKWH250G	760	x	560 x 250	234	417.55

**Fibox EK Enclosures Flange Position & Quantity**

Enclosure Ref      Quantity & Position of Flanges

- EKHA → 1 x F1 Flange on each side
- EKJB → 1 x F1 Flange on 190mm side  
1 x F2 Flange on 280mm side
- EKMB → 1 x F1 Flange on 190mm side  
1 x F2 Flange on 380mm side
- EKOE → 1 x F2 Flange on each side
- EKPE → 1 x F2 Flange on each side
- EKTH → 1 x F2 Flange on 280mm side  
2 x F2 Flanges on 560mm side
- EKUH → 1 x F2 Flange on 380mm side  
2 x F2 Flanges on 560mm side
- EKUM → 2 x F2 Flange on 560mm side  
1 x F2 Flange on one 380mm side  
1 x F3 Flange on other 380mm side
- EKUN → 2 x F2 Flange on 560mm side  
1 x F3 Flange on 380mm side
- EKWH → 2 x F2 Flanges on each side

F1 Flange opening measures 33mm x 121mm  
F2 Flange opening measures 63mm x 195mm  
F3 Flange opening measures 101mm x 306mm

**Fibox Solid Enclosure Mounting Plates**

The Fibox Solid mounting plates are made from 1.5mm thick galvanised steel.

REF NO	Plate Size (mm)			Enclosures Size (mm)			PRICE
	W	x	H	W	x	H	
EKHVT	148	x	148	190	x	190	2.89
EKJVT	238	x	148	280	x	190	4.44
EKMVT	338	x	148	380	x	190	5.68
EKOVT	238	x	238	280	x	280	6.53
EKPVT	338	x	238	380	x	280	8.34
EKTVT	538	x	238	560	x	280	23.33
EKUVT	538	x	338	560	x	380	27.78

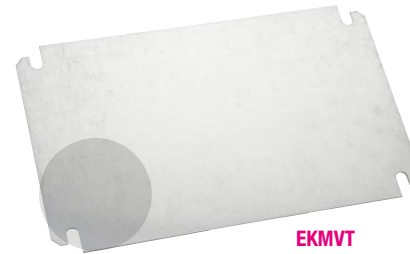

**Fibox EK Flange Plates & Fixings**

REF NO	Description	PRICE
MB10215	F1 flange cover plate	5.18
MK10437	F1 flange gasket	1.56
MB10345	M6 x 25 Plastic screw for fixing F1 flange cover ( 4 required)	0.58
3570576	M6 nut	0.12
MB10546	F2 flange cover plate	5.97
MK10438	F2 flange gasket	4.17
MB10346	M8 x 25 Plastic screw for fixing F2 flange cover ( 4 required )	0.64
3570577	M8 nut	0.34
MB10324	F3 flange cover plate	13.45
MK10439	F3 flange gasket	5.51
MB10347	M10 x 25 Plastic screw for fixing F3 flange cover ( 4 required )	0.78
3570578	M10 nut	0.37

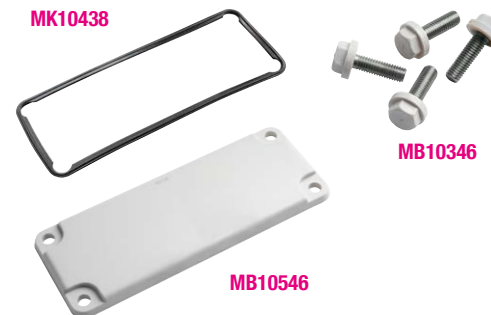

**Fibox EK Enclosure Joining Hardware**

REF NO	Description	PRICE
MB10671	Connector set + four screws for joining enclosures with 2 x F1 flange openings	1.21
MB10670	Connector set + four screws for joining enclosures with 2 x F2 flange openings	1.54
MB10672	Connector set + four screws for joining enclosures with 2 x F3 flange openings	1.80

It is recommended that the above fixing method is only used when fixing the complete assembly onto an overall mounting plate. For self supporting assemblies, the following method should be used

MB10472	M6 x 30 (4 Required) Plastic screw for joining enclosures with 2 x F1 flange openings	0.58
MB10474	M6 x 30 (4 Required) Plastic screw for joining enclosures with 2 x F2 flange openings	0.64
MB10347	M6 x 30 (4 Required) Plastic screw for joining enclosures with 2 x F3 flange openings	0.78



**Fibox EK Enclosure Depth Extension Frames**

REF NO	Dimensions (mm)	Suitable for Enclosure	PRICE
	W x D x H		
EKJZR	280 x 190 x 50	EKJB	25.40
EKMZR	380 x 190 x 50	EKMB	28.53
EKOZR	280 x 280 x 50	EKOE	31.03
EKPZR	380 x 280 x 50	EKPE	33.67
EKTZR	560 x 280 x 50	EKTH	43.45
EKUZR	560 x 380 x 50	EKUM/N	40.09



The Fibox CAB wall mounting enclosures are manufactured from high impact resistant polycarbonate or ABS material. They are electrically fully insulated.

**Polycarbonate:**  
IP 65; IK 08; NEMA Type 1, 4, 4X, 12 and 13; UL 746C 5V; UL 508  
Stable to Ultra violet lights

**ABS:**  
IP 65; IK 08; NEMA Type 1, 4, 4X, 12 and 13;  
UL 94 HB.

**IP65 RAL7035**  
**Fibox CAB Polycarbonate Enclosures Smoked Transparent Door with Latches**

REF NO	Dimensions (mm) H x W x D	No. of Latches	PRICE
CAB-PC 203018T	200 x 300 x 180	1	64.41
CAB-PC 302018T	300 x 200 x 180	2	64.41
CAB-PC 303018T	300 x 300 x 180	2	75.62
CAB-PC 304018T	300 x 400 x 180	2	96.61
CAB-PC 403018T	400 x 300 x 180	2	96.61
CAB-PC 405020T	400 x 500 x 200	2	143.56
CAB-PC 504020T	500 x 400 x 200	2	143.56
CAB-PC 604022T	600 x 400 x 220	4	206.56



CAB-PC303018G



CAB-PC151511T

**IP65 RAL7035**  
**Fibox CAB Polycarbonate Enclosures Grey Door with Latches**

REF NO	Dimensions (mm) H x W x D	No. of Latches	PRICE
CAB-PC 203018G	200 x 300 x 180	1	63.01
CAB-PC 302018G	300 x 200 x 180	2	63.01
CAB-PC 303018G	300 x 300 x 180	2	74.22
CAB-PC 304018G	300 x 400 x 180	2	94.54
CAB-PC 403018G	400 x 300 x 180	2	94.54
CAB-PC 405020G	400 x 500 x 200	2	140.73
CAB-PC 504020G	500 x 400 x 200	2	140.73
CAB-PC 604022G	600 x 400 x 220	4	203.14

**IP65 RAL7035**  
**Fibox CAB Polycarbonate Enclosures Grey Door with 3mm Double Bit Lock(s)**

REF NO	Dimensions (mm) H x W x D	No. of Locks	PRICE
CAB-PC 302018G3B	300 x 200 x 180	1	63.01
CAB-PC 303018G3B	300 x 300 x 180	1	74.22
CAB-PC 304018G3B	300 x 400 x 180	1	94.54
CAB-PC 403018G3B	400 x 300 x 180	2	94.54
CAB-PC 504020G3B	500 x 400 x 200	2	140.73
CAB-PC 604022G3B	600 x 400 x 220	2	203.14



CAB-PC 304018T3B

**IP65 RAL7035**  
**Fibox CAB Polycarbonate Enclosures Transparent Door with 3mm Double Bit Lock(s)**

REF NO	Dimensions (mm) H x W x D	No. of Locks	PRICE
CAB-PC 302018T3B	300 x 200 x 180	1	64.41
CAB-PC 303018T3B	300 x 300 x 180	1	75.62
CAB-PC 304018T3B	300 x 400 x 180	1	111.75
CAB-PC 403018T3B	400 x 300 x 180	2	96.61
CAB-PC 504020T3B	500 x 400 x 200	2	143.56
CAB-PC 604022T3B	600 x 400 x 220	2	206.56



### Fibox CAB Front Plates

The CAB front plate is made from anodised aluminium. It can be used as a rigid front plate or a swinging plate. The appropriate fixing kit needs to be ordered separately in addition to the plate. In either case, the plate mounts by attaching the mounting lugs to the variable depth combs located in the corners of the enclosure.

REF NO	Plate Size (mm) H x W	Enclosure Size (mm) H x W	PRICE
FPA23	178 x 272	200 x 300	12.24
FPA33	272 x 278	300 x 300	17.67
FPA43	372 x 278	400 x 300	22.45
MB12225AL	Swing door kit		10.71

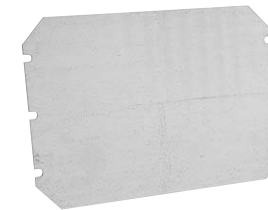

EKIV23

### Fibox CAB Enclosure Mounting Plates

The Fibox CAB Enclosure mounting plates are made from 1.5mm thick galvanised steel.

REF NO	Plate Size (mm) H x W	Enclosures Size (mm) H x W	PRICE
EKIV23	270 x 170	300 x 200	5.37
EKIV33	270 x 270	300 x 300	6.60
EKIV43	370 x 270	400 x 300	8.82
EKIV54	470 x 370	500 x 400	12.59
EKIV64	570 x 370	600 x 400	16.51

Plates can be rotated 90° for landscape enclosures. For example, the EKIV23 will fit both the 200 x 300mm and the 300 x 200mm enclosures.



FP12017



MB10564-II

### Fibox CAB Enclosure Accessories

REF NO	Description	PRICE
FP12017	Set of four wall fixing lugs	6.24
MB10564-II	Ventilation device Note: Use of this device reduces the protection rating of the enclosure to IP44	8.22



L12-II



L43-II

### Fibox Inspection Windows - IP65

The Fibox Inspection windows are made from Polycarbonate and when correctly fitted will maintain an Ingress rating of IP65

REF NO	Dimensions (mm) W x H x D	PRICE
L12-II	248 x 128 x 25	19.39
L24-II	248 x 218 x 25	24.12
L43-II	331 x 231 x 25	52.23
L44-II	377 x 331 x 25	56.87

Enclosures

The DPN range of insulated junction boxes consisting of base and lid made of ABS. They are unaffected by outdoor conditions and conform to IEC998-1 & 998.2-5.

They are self-extinguishing and have high impact resistance. The bases can be fixed directly to the wall and caps are supplied with the enclosure to ensure watertightness and double insulation. The 30/22 and 40/30 models come with internal hinges as standard.



**Mounting Plates for DPN Enclosures**

DIN Rail may be fixed to the inside of the enclosure by using self tapping screws. Alternatively a backplate can be used, if required.

REF NO	Plate Size (mm)			Suitable for Enclosure	PRICE
	H	x	W		
PMDP-1510 (SL09135)	135	x	100	DPN15/10	3.82
PMDP-2015 (SL09137)	170	x	130	DPN20/15	4.75
PMDP-2520 (SL09138)	230	x	170	DPN25/20	7.03
PMDP-3022 (SL09139)	282	x	232	DPN30/22	10.66
PMDP-4030 (SL09140)	360	x	275	DPN40/30	12.95



**IP55 RAL7035 DPN Enclosures - Plain Sides & Plain Grey Lid**

REF NO	Dimensions (mm)			PRICE
	H	x	W x D	
DPN10/10 (SL00925)	103	x	103 x 56	4.06
DPN12/8 (SL00931)	123	x	83 x 56	4.50
DPN15/10 (SL00932)	152	x	114 x 76	4.97
DPN20/15 (SL00937)	194	x	144 x 78	7.46
DPN25/20 (SL00938)	244	x	194 x 96	11.14
DPN30/22 (SL00939)	306	x	226 x 127	35.54
DPN40/30 (SL00940)	389	x	310 x 128	49.04

DPN30/22



DPN10/10



DPC65

DPC80



DPC8/8

**IP55 RAL7035 DPC Enclosures with Stepped Entries**

REF NO	Description	PRICE
DPC65 (SL00065)	65mm round box with four stepped entries	1.41
DPC80 (SL00080)	80mm round box with four stepped entries	1.68
DPC8/8 (SL00088)	80mm square box with four stepped entries	2.16

Enclosures

The Thalassa NSYTBS ABS range of insulated industrial boxes are rated to IP66 and are available with both solid and transparent lids. The range of ABS enclosures are perfect for use in conventional applications.

These Class II enclosures are self-extinguishing and have an impact rating of IK07 according to IEC 62262.

They are supplied with screw lids but hinges are available for the 20mm - 40mm covers versions.

*This range of enclosures are also available in a polycarbonate version - NSYTBP\*\*\* Contact us for more information*



NSYTBS19168



NSYTBS19128T

**IP66 RAL7035 Thalassa NSYTBS Enclosures - ABS - Grey Lid**

REF NO	Dimensions (mm)			Body mm	Cover mm	PRICE
	H	x	W x D			
NSYTBS775	74	x	74 x 54	37	10	2.79
NSYTBS885	89	x	89 x 54	37	10	3.03
NSYTBS1176	116	x	74 x 62	45	10	3.73
NSYTBS1179H	116	x	74 x 94	45	40	4.16
NSYTBS11116	116	x	116 x 62	45	10	4.49
NSYTBS111113H	116	x	116 x 133	45	80	5.61
NSYTBS1397	138	x	93 x 72	45	20	5.43
NSYTBS16128	164	x	121 x 87	60	20	8.44
NSYTBS19128	192	x	121 x 87	60	20	9.20
NSYTBS191210H	192	x	121 x 105	60	40	10.17
NSYTBS19168	192	x	164 x 87	60	20	13.07
NSYTBS191610H	192	x	164 x 105	60	40	13.44
NSYTBS24198	241	x	194 x 87	60	20	13.69
NSYTBS241910	241	x	194 x 107	80	20	15.19
NSYTBS241910H	241	x	194 x 107	60	40	15.05
NSYTBS241912H	241	x	194 x 127	80	40	16.94
NSYTBS29248	291	x	241 x 88	60	20	24.85
NSYTBS292412	291	x	241 x 128	100	20	27.26
NSYTBS292412H	291	x	241 x 128	60	60	26.50
NSYTBS292416H	291	x	241 x 168	100	60	36.42
NSYTBS342912	341	x	291 x 128	100	20	38.61
NSYTBS342916H	341	x	291 x 168	100	60	48.08

**Mounting Plates & Accessories for NSYTBS Enclosures**

Standard galvanised-steel backplates are available for all enclosures 192 x 164mm and above. If you require a insulated polyester backplate please contact us.

REF NO	Plate Size (mm)	Suitable for Enclosures	PRICE		
	H	x	W		
NSYAMP1916TB	168	x	140	192 x 164mm	3.31
NSYAMP2419TB	215	x	168	241 x 194mm	4.40
NSYAMP2924TB	265	x	215	291 x 241mm	6.85
NSYAMP3429TB	315	x	265	341 x 291mm	8.79
NSYAFTB	Set of 4 Wall Fixing Lugs for enclosures from 116 x 116mm			4.34	
NSYAEDH20TB	Set of 2 Hinges For all covers with a height of 20mm			4.50	
NSYAEDH40TB	Set of 2 Hinges For all covers with a height of 40mm			4.62	



NSYAEDH20TB

**IP56 RAL7035**  
Pico Enclosures - ABS - Low Grey Lid

REF NO	Dimensions (mm)			PRICE
	H	x	W x x D	
B04841	100	x	100 x 50	1.94
B04842	120	x	80 x 50	1.97
B04843	150	x	110 x 70	3.13
B04844	190	x	140 x 70	5.09
B04845	240	x	190 x 90	9.91
B04846	300	x	220 x 120	15.16
B04847	380	x	300 x 120	22.81
B04848	460	x	380 x 120	29.78

A cost effective range of halogen free, ABS, smooth walled junction boxes in the popular sizes. Rated to IP56 and available with grey or transparent lid.

Conforms to EN60670-22.

Glow wire test 650°C self-extinguishing according to IEC 695-2-1.

Sizes 190 x 140mm and larger come with internal lid straps.

**IP56 RAL7035**  
Pico Enclosures - ABS - Low Clear Lid

REF NO	Dimensions (mm)			PRICE
	H	x	W x x D	
B04853	150	x	110 x 70	3.78
B04854	190	x	140 x 70	6.53
B04855	240	x	190 x 90	10.41
B04856	300	x	220 x 120	18.47
B04857	380	x	300 x 120	25.84
B04858	460	x	380 x 120	32.66

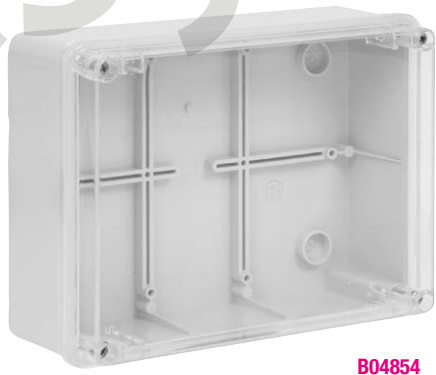
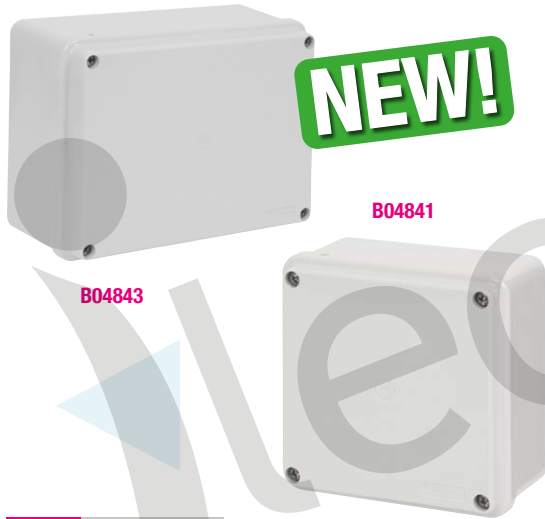

**IP56 RAL7035**  
Pico Enclosures - ABS - High Grey Lid

REF NO	Dimensions (mm)			PRICE
	H	x	W x x D	
B04849	240	x	190 x 160	12.13
B04850	300	x	220 x 180	17.22
B04851	380	x	300 x 180	27.13
B04852	460	x	380 x 180	34.88

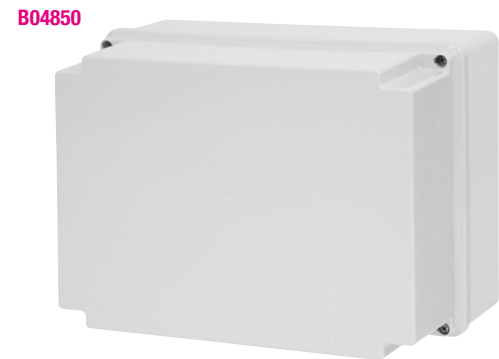

Pico Backplates

REF NO	Plate Size (mm)		Enclosure Size (mm)		PRICE		
	H	x	H	x		W	
B04862	170	x	130	190	x	140	4.75
B04863	230	x	170	240	x	190	6.13
B04864	286	x	208	300	x	220	8.72
B04865	363	x	282	380	x	300	14.09
B04866	438	x	360	460	x	380	21.94
B04861	Wall mounting Bracket (4 Required)				0.50		



**IP56 RAL7035**  
Gewiss Surface Mounting Boxes Low Lid Grey Lid

REF NO	Dimensions (mm)			PRICE
	H	x	W x x D	
GW44204	100	x	100 x 50	3.35
GW44205	120	x	80 x 50	3.35
GW44206	150	x	110 x 70	4.95
GW44207	190	x	140 x 70	9.65
GW44208	240	x	190 x 90	15.80
GW44209	300	x	220 x 120	28.60
GW44210	380	x	300 x 120	39.70
GW44211	460	x	380 x 120	56.70

A range of popular surface mounted boxes protected to IP56 and coloured to RAL7035. The boxes have smooth walls and are available with a low or deep lid in grey or transparent.

**IP56 RAL7035**  
Gewiss Surface Mounting Boxes Low Lid Transparent Lid

REF NO	Dimensions (mm)			PRICE
	H	x	W x x D	
GW44426	150	x	110 x 70	10.70
GW44427	190	x	140 x 70	19.60
GW44428	240	x	190 x 90	30.60
GW44429	300	x	220 x 120	44.10
GW44430	380	x	300 x 120	63.80
GW44431	460	x	380 x 120	91.20

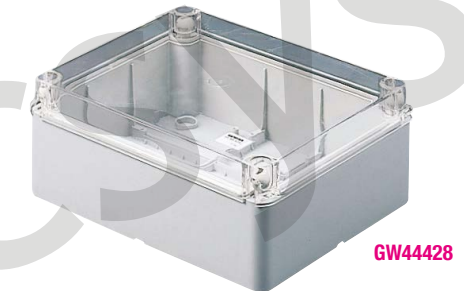
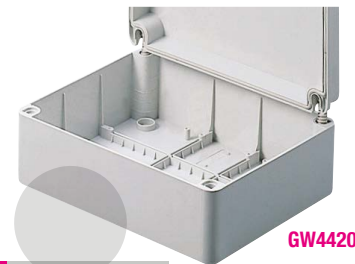

**IP56 RAL7035**  
Gewiss Surface Mounting Boxes Deep Lid Grey Lid

REF NO	Dimensions (mm)			PRICE
	H	x	W x x D	
GW44214	100	x	100 x 120	4.95
GW44215	120	x	80 x 120	4.95
GW44216	150	x	110 x 140	7.30
GW44217	190	x	140 x 140	12.60
GW44218	240	x	190 x 160	19.50
GW44219	300	x	220 x 180	33.50
GW44220	380	x	300 x 180	44.90
GW44221	460	x	380 x 180	64.80



**IP56 RAL7035**  
Gewiss Surface Mounting Boxes Deep Lid Transparent Lid

REF NO	Dimensions (mm)			PRICE
	H	x	W x x D	
GW44436	150	x	110 x 140	15.80
GW44437	190	x	140 x 140	24.00
GW44438	240	x	190 x 160	36.60
GW44439	300	x	220 x 180	51.20
GW44440	380	x	300 x 180	78.60
GW44441	460	x	380 x 180	107.00

Gewiss Surface Mounting Boxes - Backplates

REF NO	Plate Size (mm)		Enclosure Size (mm)		PRICE		
	H	x	H	x		W	
GW44615	170	x	130	190	x	140	2.55
GW44616	230	x	170	240	x	190	3.85
GW44617	286	x	208	300	x	220	5.60
GW44618	363	x	282	380	x	300	16.20
GW44619	438	x	360	460	x	380	19.90
GW44621	Wall mounting Bracket (4 Required)				0.37		



The Wiska Combi range are IP66 according to EN60529 and have a temperature range of -30°C to +100°C. Manufactured from Glass fibre reinforced Polypropylene they are available in Black, Grey or White and with or without a terminal block. The lids have 4 captive quick-release lid screws.



**IP66**

**Wiska Combi 308 - 85mm x 85mm x 51mm**

The Combi 308 has 8 x Elastic self-sealing membranes. These entries also have integrated M20 threads.

REF NO	Description	PRICE
10060400	Combi 308 - Empty box in Grey	4.84
10060581	Combi 308 - Empty box in Black	4.84
10060610	Combi 308 - Empty box in White	4.84
10060401	Combi 308 - Grey Box with 5 Pole 4mm <sup>2</sup> Terminal block	5.56
10060580	Combi 308 - Black Box with 5 Pole 4mm <sup>2</sup> Terminal block	5.56
10060611	Combi 308 - White Box with 5 Pole 4mm <sup>2</sup> Terminal block	5.56



**IP66**

**Wiska Combi 607 - 110mm x 110mm x 66mm**

The Combi 607 has 7 x Elastic self-sealing membranes with integrated M25 threads in the sides. There are also 3 self-sealing membranes in the base.

REF NO	Description	PRICE
10060531	Combi 607 - Empty box in Grey	7.90
10060648	Combi 607 - Empty box in Black	7.90
10060533	Combi 607 - Empty box in White	7.90
10061778	Combi 607 - Grey Box with 5 Pole 6mm <sup>2</sup> Terminal block	8.60
10061779	Combi 607 - Black Box with 5 Pole 6mm <sup>2</sup> Terminal block	8.60
10060534	Combi 607 - White Box with 5 Pole 6mm <sup>2</sup> Terminal block	8.60

**IP66**

**Wiska Combi 1010 - 140mm x 140mm x 82mm**

The Combi 1010 has 10 x Elastic self-sealing membranes with integrated threads in the sides. 5 x M25/32; 2 x M20; 3 x M20/M25. There are also 4 knock-out entries in the base. 2 x M25/32; 2 x M20/25.

REF NO	Description	PRICE
10060702	Combi 1010 - Empty box in Grey	13.18
10062214	Combi 1010 - Empty box in Black	13.18
10062210	Combi 1010 - Empty box in White	13.18
10060703	Combi 1010 - Grey Box with 5 Pole 10mm <sup>2</sup> Terminal block	19.84
10062215	Combi 1010 - Black Box with 5 Pole 10mm <sup>2</sup> Terminal block	19.84
10062211	Combi 1010 - White Box with 5 Pole 10mm <sup>2</sup> Terminal block	19.84



**IP66**

**Wiska Combi 1210 - 160mm x 140mm x 81mm**

The Combi 1210 has 10 x Elastic self-sealing membranes with integrated M20 threads with M25 breakout option in the sides.

REF NO	Description	PRICE
10101459	Combi 1210 - Empty box in Grey	15.22
10101460	Combi 1210 - Empty box in Black	15.22
10101461	Combi 1210 - Empty box in White	15.22
10101462	Combi 1210 - Grey Box with 5 Pole 10mm <sup>2</sup> Terminal block	16.70
10101463	Combi 1210 - Black Box with 5 Pole 10mm <sup>2</sup> Terminal block	16.70
10101464	Combi 1210 - White Box with 5 Pole 10mm <sup>2</sup> Terminal block	16.70



KINCO

Lovato

Control Relays & Accessories

See Our Full Range on Pages 340-341

A very popular range of junction boxes made from flame resistant polystyrene. The boxes are available in 6 different sizes with a terminal capability of 1 - 35mm<sup>2</sup>. Operating temperature is -25°C to +40°C. They are rated at IP65.

**IP65**  
Spelsberg ABox 025 AB - 80mm x 80mm x 52mm with Flange

The ABox 025 comes with 7 x M20 self-sealing soft entry membranes with a seal range of 2-16mm, cable range of 1-4mm<sup>2</sup>. Each connection of the five pole terminal block will take 4 x 1.5mm<sup>2</sup>, 4 x 2.5mm<sup>2</sup> or 3 x 4mm<sup>2</sup>.

REF NO	Description	PRICE
803-907	ABox 025/AB L - Empty box in grey with flanges	2.95
803-407	ABox 025-2.5 <sup>2</sup> - Grey box with flanges and five pole 1.5-4mm <sup>2</sup> screw terminal block	4.20



**IP65**  
Spelsberg ABox 025 - 80mm x 80mm x 52mm

The ABox 025 comes with 7 x M20 self-sealing soft entry membranes with a seal range of 2-16mm, cable range of 1-4mm<sup>2</sup>. Each connection of the five pole terminal block will take 4 x 1.5mm<sup>2</sup>, 4 x 2.5mm<sup>2</sup> or 3 x 4mm<sup>2</sup>.

REF NO	Description	PRICE
802-907	ABox 025L - Empty box in grey	2.95
802-607	ABox 025L - Empty box in white	3.07
802-707	ABox 025SB - Empty box with red lid to identify safety power circuits to comply with DIN VDE 0108	3.57
802-407	ABox 025-2.5 <sup>2</sup> - Grey box with five pole 1.5mm-4mm <sup>2</sup> screw terminal block	4.19
802-107	ABox 025-2.5 <sup>2</sup> - White box with five pole 1.5mm-4mm <sup>2</sup> screw terminal block	4.33



**IP65**  
Spelsberg ABox 045 - 93mm x 93mm x 55mm

The ABox 040 comes with 7 x M20 self-sealing soft entry membranes with a seal range of 2-16mm, cable range of 1-4mm<sup>2</sup>. Each connection of the five pole terminal block will take 4 x 1.5mm<sup>2</sup>, 4 x 2.5mm<sup>2</sup> or 3 x 4mm<sup>2</sup>.

REF NO	Description	PRICE
804-907	ABox 040L - Empty box in grey	3.69
804-607	ABox 040L - Empty box in white	4.02
804-407	ABox 040-4 <sup>2</sup> - Grey box with five pole 1.5mm-4mm <sup>2</sup> screw terminal block	4.91
804-107	ABox 040-4 <sup>2</sup> - White box with five pole 1.5mm-4mm <sup>2</sup> screw terminal block	5.24

**IP65**  
Spelsberg ABox 060 - 110mm x 110mm x 67mm

The ABox 060 comes with 7 x M20/M25 knock-outs. Each connection of the five pole terminal block will take 4 x 1.5mm<sup>2</sup>, 4 x 2.5mm<sup>2</sup>, 4 x 4mm<sup>2</sup> or 3 x 6mm<sup>2</sup> cables.

REF NO	Description	PRICE
806-907	ABox 060L - Empty box in grey	7.19
806-407	ABox 060-6 <sup>2</sup> - Grey box with five pole 6mm <sup>2</sup> screw terminal block	10.15



**IP65**  
Spelsberg ABox 100 - 140mm x 140mm x 79mm

The ABox 100 comes with 5 x M20/M25 knock-outs and 5 x M25/M32 knock-outs.

REF NO	Description	PRICE
810-910	ABox 100L - Empty box in grey	9.53
810-410	ABox 100-10 <sup>2</sup> - Grey box with five pole 10mm <sup>2</sup> screw terminal block	14.26



**IP65**  
Spelsberg ABox 160 - 180mm x 180mm x 91mm

The ABox 160 comes with 2 x M20, 3 x M25/M32 and 5 x M32/M40 knock-outs.

REF NO	Description	PRICE
816-910	ABox 160L - Empty box in grey	15.24
816-410	ABox 160-16 <sup>2</sup> - Grey box with five pole 16mm <sup>2</sup> screw terminal block	23.58



**Nylon Cable Glands - IP68**

Zero halogen nylon cable compression glands for use with unarmoured cable. Available in black and grey as standard but also white and red. Working Temperature: -40°C to +100°C.

Ref No	Cable Dia Range	Thread Size	Thread Length	Price
EPN250/M16RN	2 - 7mm	16mm	8mm	0.30
EPN250/M16N	4.5 - 10mm	16mm	8mm	0.27
EPN250/M20RN	5 - 9mm	20mm	9mm	0.28
EPN250/M20N	6 - 12mm	20mm	9mm	0.22
EPN250/M20E	10 - 14mm	20mm	10.2mm	0.44
EPN250/M25RN	6 - 13mm	25mm	10mm	0.55
EPN250/M25N	9 - 17mm	25mm	10mm	0.51
EPN250/M25E	13 - 18mm	25mm	11mm	0.59
EPN250/M32RN	7 - 15mm	32mm	10mm	1.65
EPN250/M32N	11 - 25mm	32mm	10mm	1.15



**Hexagonal Locknuts - Flangeless**

Ref No	Description	Price
EPN355/M16	16mm Flangeless Locknut	0.08
EPN355/M20	20mm Flangeless Locknut	0.06
EPN355/M25	25mm Flangeless Locknut	0.20
EPN355/M32	32mm Flangeless Locknut	0.30

The Pablo is a modular enclosure available in 8 sizes, with and without an earth terminal option.

- IP65 Ingress Protection
- IK09 Impact Resistance
- Conforms to IEC60670-24 and EN62208
- Manufactured from Halogen Free ABS
- Operating Temperature -25°C to +60°C
- Rated Insulation Voltage 1000VAC - 1500VDC

**IP65**

**Bocchiotti Pablo Modular Enclosures 2+ Rows**

REF NO	18mm Modules	Dimensions (mm) H x W x D	PRICE
B06525	24 Modules / 2 Rows	420 x 314 x 133	51.06
B06526	36 Modules / 2 Rows	470 x 426 x 133	65.46
B06527	54 Modules / 3 Rows	657 x 426 x 133	56.20
B06528	72 Modules / 4 Rows	903 x 426 x 159	152.80

**IP65**

**Bocchiotti Pablo Modular Enclosures with Earth Bar**

These Bocchiotti Pablo Enclosures come complete with earth bar and blanks.

REF NO	18mm Modules	Dimensions (mm) H x W x D	PRICE
B06534	4 Modules / 1 Row	210 x 143 x 100	14.94
B06537	8 Modules / 1 Row	210 x 215 x 100	23.71
B06540	12 Modules / 1 Row	263 x 314 x 133	36.51
B06542	18 Modules / 1 Row	288 x 426 x 139	50.29
B06541	24 Modules / 2 Rows	420 x 426 x 133	60.69
B06543	36 Modules / 2 Rows	470 x 426 x 133	77.11
B06544	54 Modules / 3 Rows	657 x 426 x 133	96.69



B06521



B06525

**IP65**

**Bocchiotti Pablo Modular Enclosures - Single Row**

REF NO	18mm Modules	Dimensions (mm) H x W x D	PRICE
B06521	4 Modules / 1 Row	210 x 143 x 100	13.03
B06522	8 Modules / 1 Row	210 x 215 x 100	16.20
B06523	12 Modules / 1 Row	263 x 314 x 133	32.20
B06524	18 Modules / 1 Row	288 x 426 x 139	38.17



B06523

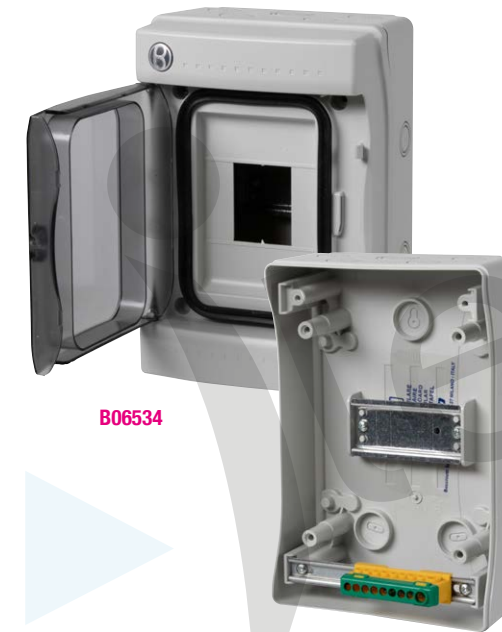

B06534



B06541



B06544

**Accessories**

REF NO	Description	PRICE
B05161	Key lock	11.03
B05160	Wall Mounting Fixings (Set of 4)	1.06
B05192	6 Way Neutral Block	4.57



B05192



B05161



B05160

**DIN Rail Kits**

REF NO	Description	PRICE
B05193	Additional Rail for 12 Module wide Enclosures for mounting additional Neutral Blocks	5.03
B05194	Additional Rail for 18 Module wide Enclosures for mounting additional Neutral Blocks	5.51



B05193

**Breakers & Accessories**

See our full range on pages 202-221

Or call us to discuss your requirements



Glass Reinforced Polyester (GRP) enclosures have proven their worth in many industrial plants. They offer safe protection even when they are used under extremely unfavorable conditions, on exposure to aggressive chemical media or hard mechanical conditions. The base contains threaded bushes for fastening DIN rail.

The lids are secured using 316 grade captive stainless steel screws



### IP66 RAL9005 Black GRP Enclosures

REF NO	Dimensions (mm) H x W x D	Internal Depth	PRICE
07-5195-0800/7555	75 x 80 x 55	47.5mm	15.83
07-5195-1100/7555	75 x 110 x 55	47.5mm	14.90
07-5195-1600/7555	75 x 160 x 55	47.5mm	21.17
07-5195-1900/7555	75 x 190 x 55	47.5mm	27.47
07-5195-1221/2090	120 x 122 x 90	80mm	26.30
07-5195-1221/2012	120 x 122 x 120	109mm	35.15
07-5195-2201/2090	120 x 220 x 90	80mm	41.20
07-5195-1601/6090	160 x 160 x 90	80mm	37.70
07-5195-1601/6012	160 x 160 x 120	109mm	66.58
07-5195-2601/6090	160 x 260 x 90	80mm	50.30
07-5195-3601/6090	160 x 360 x 90	80mm	61.70
07-5195-5601/6090	160 x 560 x 90	80mm	184.85
07-5195-2002/5012	200 x 255 x 120	109mm	60.76
07-5195-2552/5012	250 x 255 x 120	109mm	72.65
07-5195-2552/5016	250 x 255 x 160	149mm	75.66
07-5195-4002/5012	250 x 400 x 120	109mm	85.20
07-5195-4002/5016	250 x 400 x 160	149mm	91.02
07-5195-4004/0512	400 x 405 x 120	109mm	161.80
07-5195-4004/0516	400 x 405 x 160	149mm	201.86
07-5195-6002/5012	600 x 250 x 120	109mm	116.88

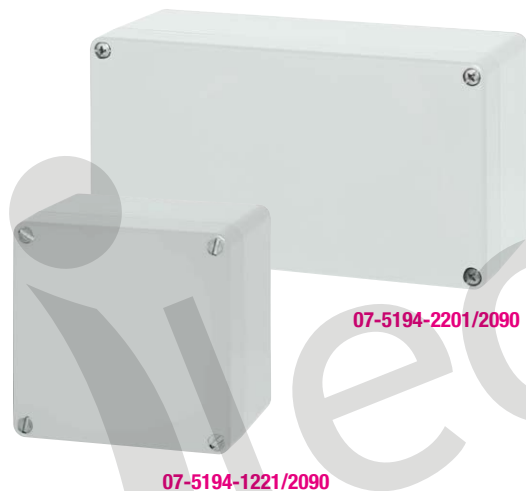

### IP66 RAL7001 Grey GRP Enclosures

REF NO	Dimensions (mm) H x W x D	Internal Depth	PRICE
07-5194-0800/7555	75 x 80 x 55	47.5mm	14.43
07-5194-1100/7555	75 x 110 x 55	47.5mm	13.50
07-5194-1600/7555	75 x 160 x 55	47.5mm	19.55
07-5194-1900/7555	75 x 190 x 55	47.5mm	26.06
07-5194-1221/2090	120 x 122 x 90	80mm	21.88
07-5194-1221/2012	120 x 122 x 120	109mm	30.03
07-5194-2201/2090	120 x 220 x 90	80mm	36.32
07-5194-1601/6090	160 x 160 x 90	80mm	30.28
07-5194-1601/6012	160 x 160 x 120	109mm	39.33
07-5194-2601/6090	160 x 260 x 90	80mm	36.55
07-5194-3601/6090	160 x 360 x 90	80mm	53.08
07-5194-5601/6090	160 x 560 x 90	80mm	176.95
07-5194-2552/5012	250 x 255 x 120	109mm	55.41
07-5194-2552/5016	250 x 255 x 160	149mm	55.41
07-5194-4002/5012	250 x 400 x 120	109mm	65.88
07-5194-4002/5016	250 x 400 x 160	149mm	80.10
07-5194-4004/0512	400 x 405 x 120	109mm	126.20
07-5194-4004/0516	400 x 405 x 160	149mm	379.48
07-5194-6002/5012	600 x 250 x 120	109mm	95.91

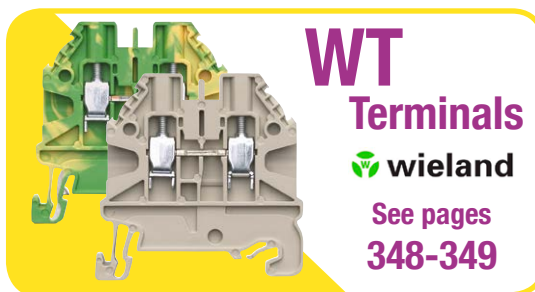

### IP65 Connect Series ELEG

A range of die-cast aluminium alloy enclosures UNI 5079. The wall thickness is 3mm and there are earthing points in the base and cover. The enclosures which have an operating temperature of -40°C to +100°C can be fixed by using internal screws and sealing caps or external brackets which are included as standard

REF NO	Dimensions (mm) H x W x D	Internal Depth (mm)	PRICE
E102.102	106 x 106 x 71	64	10.74
E135.110	142 x 117 x 71	64	15.66
E160.135	167 x 142 x 81	74	17.89
E185.160	192 x 167 x 96	89	26.55
E245.210	254 x 219 x 102	94	40.29
E295.255	302 x 262 x 130	117	78.13

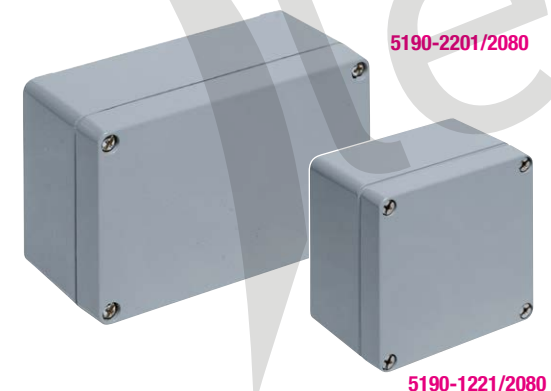

### IP66 RAL7001 Connect Series 5190

A range of die-cast aluminium enclosures painted to RAL7001. Sizes conform to European Norm sizes

REF NO	Dimensions (mm) H x W x D	Internal Depth (mm)	PRICE
5190-0750/8057	75 x 80 x 57	45	15.60
5190-1250/8057	120 x 80 x 57	45	20.35
5190-1221/2080	120 x 120 x 80	63	32.30
5190-1221/2090	122 x 120 x 90	73	33.28
5190-2201/2080	220 x 120 x 80	63	39.85
5190-2201/2090	220 x 120 x 90	73	44.55
5190-1601/6090	160 x 160 x 90	73	45.75
5190-2601/6090	260 x 160 x 90	73	61.05

### IP65 Connect Series GAIN

A range of die-cast aluminium alloy enclosures UNI 5079. The wall thickness is 3mm and there are earthing points in the base and cover. The enclosures which have an operating temperature of -40°C to +100°C and have fixing holes outside the gasketed area. They also have internal guides for printed circuit boards.

REF NO	Dimensions (mm) H x W x D	Internal Depth (mm)	PRICE
G060.38	66 x 66 x 44	35	10.08
G070.34	76 x 76 x 40	31	10.08
G085.54	91 x 91 x 61	54.5	12.16
G100.54	106 x 106 x 61	55	13.37
G100.74	106 x 106 x 81	75	15.82
G120.34	126 x 78.5 x 41	34.5	12.16
G120.54	126 x 78.5 x 61	54.5	12.16
G120.68	126 x 78.5 x 75	68.5	13.37
G130.68	133 x 133 x 75	69	21.45
G130.84	130 x 130 x 91	85	22.61
G150.54	152 x 102 x 61	55	17.32
G150.74	152 x 102 x 81	75	18.42
G200.54	206 x 106 x 61	55	19.47
G200.74	206 x 106 x 81	75	20.66
G200.94	202 x 102 x 94	88	21.66
G200.114	202 x 102 x 114	108	22.71
G250.54	256 x 91 x 61	54.5	22.53
G250.68	256 x 91 x 75	69	23.74
G260.68	266 x 131 x 75	69	29.74
G260.84	266 x 131 x 91	85	30.97

