



**Precision Instruments Skyray Elaborates**

**USA Office:**

Add: 639 Granite Street, suite 222 Braintree, MA02184  
Tel: +1-617-202-3879  
Fax: +1-617-202-3878  
Website: www.skyrayinstrument.com  
E-mail: sales@skyray-instrument.com

**Kunshan Office:**

Add: Skyray Building, Tsinghua Science Park, 1666,  
South Weicheng Rd., Kunshan, Jiangsu Province  
Tel: +86-0512-57017006 57017018 57017886 57017880  
Fax: +86-0512-57017357  
Website: www.skyray-instrument.com www.gold-tester.com  
E-mail: sales@skyray-instrument.com sales@gold-tester.com

**Shenzhen Office:**

Add: Floor 3(rd), Block D, Keepon Industry Zone, Chongqing  
Rd., Fuyong Town, Bao'an District, Shenzhen, China  
Tel: +86-0755-81459355 81459357 81459359  
Fax: +86-0755-81459301  
Website: www.gold-tester.com  
E-mail: sales@gold-tester.com  
Hotline: 800-9993-800



**ICP-2000**

**Sequential Inductively Coupled Plasma Spectrometer**



## Precision Instruments Skyray Elaborates

### Company Profile

Established in 1992, **Skyray Instrument Inc** specializes in the development, manufacture, sales and support of analytical instruments. It is situated in the scenery Tsinghua Science Park, Kunshan, Jiangsu Province, with the largest sales center in Keepon Industry Zone, Chongqing Rd., Fuyong town, Bao'an District, Shenzhen. Its subsidiary companies are Jiangsu Skyray Information Technology Co., LTD, Beijing Bandwise Technology Development Co., LTD, Beijing F.Y. Be Realistic General Instrument Co., LTD.

Skyray Instrument Inc. possesses the first-class expert team in the world, strong R&D strength, unparalleled technology, reputable service and advanced management mode. It has been recognized as Jiangsu Provincial High-tech Corporation, Kunshan Company Technology Center, Kunshan Key Private-owned Enterprise, RoHS Testing Lab 2 of Kunshan Institute of Product Quality Supervision and Inspection, Suzhou Analytical Instruments Engineering Research Center. It was also granted with 55 patents including Utility Model Patents, Design Patents, Software Copyright Registration and Copyright Registration Patents. It has set up two research institutes named Skyray Research Center of Technology and Skyray Academy of Analytical and Measuring Instruments.

Skyray products range from X-ray Fluorescence Spectrometers (XRF), Inductively Coupled Plasma Spectrometers (ICP), Atomic Absorption Spectrometers (AAS), Gas Chromatograph (GC), Liquid Chromatograph (LC) to Energy Dispersive Microanalysis System (EDS). Their main applications are focused on environmental protection and natural resources exploration and utilization. The application fields include electric and electronic (RoHS), jewelries and ornaments (precious metals, plating thickness), toy safety (En71-3), building materials (cement, glass, ceramic), metallurgy (steel, non-ferrous metals), petroleum (trace elements S, Pb, etc), chemical engineering, mining, commodity inspection, quality control, and human body trace elements testing. The company has occupied 80% the share of the domestic RoHS analyzer market.

Skyray is the most trustworthy friend of the users as it implements rigid quality controls on its products, pursues technological innovation ceaselessly and offers technical support promptly. Skyray products command a good market both at home and abroad. They enjoy popularity in counties and regions such as America, Germany, Italy, Austria, Spain, Switzerland, Australia, Belarus, Holland, Belgium, Luxemburg, Brazil, Croatia, Turkey, Iran, South Korea, Thailand, Philippine, Columbia, Singapore, Indonesia, Oman, Vietnam, Malaysia, India, United Arab Emirates, South Africa, Egypt, Syria and Sudan. Up to now Skyray has won three World's No.1 titles in XRF field: No. 1 in Sales Amount, No. 1 in Product Categories and No. 1 in Key Patented Technologies.

## ICP-2000 Sequential Inductively Coupled Plasma Spectrometer



### Application fields:

ICP-2000 is capable of measuring approximately 70 trace to constant elements in different materials. Wide application extends to geology, metallurgy, rare earth materials, electroplating, cement, petroleum, chemical engineering, environmental monitoring, non-ferrous metals, medical science and hygiene, food, agriculture, scientific research Institutes, colleges, and other industrial enterprises.

### Main characteristics of ICP-AES:

- ◇ Simultaneous measurement of multi elements
- ◇ Low detection limit: 0.1-10ppb, and even lower
- ◇ Wide density linear range, 5-6 digits
- ◇ Least chemical interference, maximum accuracy, RSD ≤ 2%
- ◇ High analysis speed, low cost

[www.skyray-instrument.com](http://www.skyray-instrument.com) / [www.gold-tester.com](http://www.gold-tester.com)

### The Instrument Structure

The instrument consists of five parts:

- Radio Frequency Generator
- Sample Introduction System
- Optical System
- Photoelectric Conversion Device
- Computer

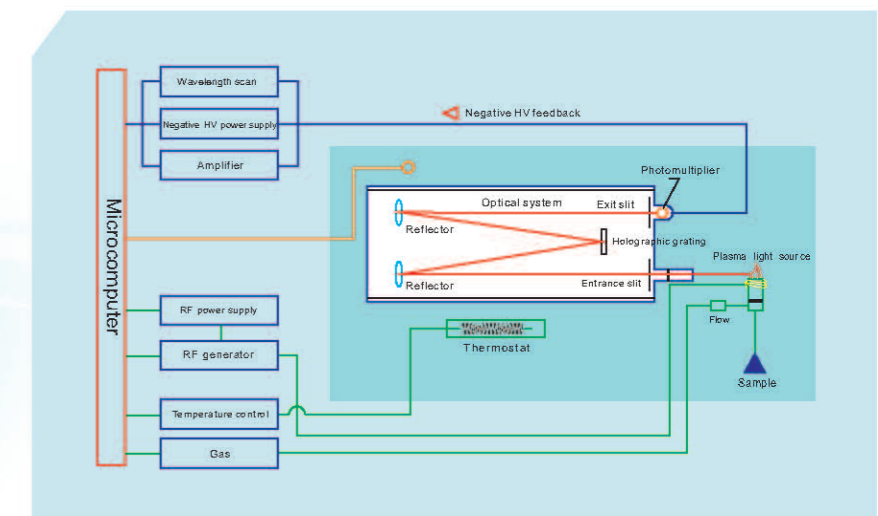

## Radio Frequency Generator

RF generator's precision parts ensure stable output power; military electron tube offers increased reliability; improved feedback mechanism provides better stability.

### RF Generator Specifications:

- 1). Circuit type: inductively feedback self-oscillation circuit, coaxial cable transmission, matched tuning, power feedback close loop auto control
- 2). Working frequency:  $40\text{MHz} \pm 0.05\%$
- 3). Frequency stability:  $< 0.1\%$
- 4). Power output: 800W 1200W
- 5). Power output stability:  $< 0.3\%$
- 6). Intensity of electromagnetic leakage: electric field intensity:  $E: < 2\text{V/m}$  @30cm form shell.



▲ High Frequency Box

High Frequency Box excites very stable plasma torch by exploiting the inductively feedback self-oscillation circuit. The circuit is transmitted by coaxial cable, matchingly tuned and implements close-loop auto-control by means of power feedback (National Patented Invention). Industrial argon can be used in this kind of generator, which not only makes the lighting the ICP torch easy but also saves the cost of highly purified argon.



▲ Match box

The high performance match box is composed of vacuum ceramic adjustable capacitors and gas adjustable capacitors, which allows it to reach the best match state and achieve maximum effective output on load coils.



▲ Directional coupler

The stability of power output is achieved by controlling the anode voltage of oscillation valve after the power signals are sent out of the directional coupler and get amplified by the amplifier.

### Sample introduction system specifications:

- 1). Inner diameter of output coils: 25 mm, 3 coils
- 2). Torch: three concentric torches, outer diameter 20 mm, quartz
- 3). Outer diameter of coaxial nebulizer: 6mm
- 4). Outer diameter of double-pass spray chamber: 34mm
- 5). Specifications of Ar flowmeter and carrier gas pressure gauge:
  - ① Plasma gas flowmeter(100-1000) L/h (1.6-16L/min)
  - ② Auxiliary gas flowmeter (10-100) L/h (0.16-1.66L/min)
  - ③ Carrier gas flowmeter 10-100 L/h (0.16-1.66L/min)
  - ④ Carrier gas pressure stabilization valve (0-0.4MPa)
  - ⑤ Cooling water: Water temperature: 15-25°C Water pressure:  $> 0.1\text{MPa}$  Resistivity  $> 1\text{M}\Omega$

## Sample introduction system

In this system, coaxial nebulizer, double-pass and cyclone spray chambers, high salt and conventional torch tubes, and their free and optimized combinations all contribute to the measurement of various kinds of samples. Meanwhile, the system is easy to clean, replace and install. A 2-channel 10-roller peristaltic pump uses one of its channels for sample introduction, resulting in uniform and stable sample introduction, and the other channel for pumping away the waste, minimizing the influence the waste peristalsis has had on the sample introduction. Direct-drive and digital, the peristaltic pump delivers ease and simplicity of operation.

Both R.F generator and plasma load coils are cooled by circulated cooling water. ICP-2000 is equipped with the in-house designed AC-2500 auto temperature control water cooling system, which is characterized by good cooling results, strong cooling capability, wide range temperature control and low noise.



▲ Auto temperature control water cooling system

## Optical system

The optical system utilizes the horizontal asymmetric optical path to reduce the width of the system and eliminate the interference of the stray lights. With adoption of large-area grating with long focal length, the relative aperture is broadened and sensitivity enhanced. At the same time, by using special metal material and finely-lapped fixed slits, it delivers superior measurement results in great precision.

By using the imported precise and reliable step motor as the drive device of the grating, the system offers stable mechanical transmission, resulting in good stability and repeatability. The rotation of the grating is driven by the fine-pitch worm gear directly, ensuring high precision and minimal accumulated error. The optical system offers the ultimate in temperature  $32^\circ\text{C} \pm 1^\circ\text{C}$  with the thermostatic device.

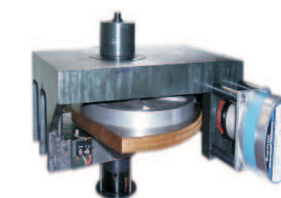

▲ Grating drive



▲ Optical system

### Optical system specifications:

- 1). Optical path: Czerny-Turner
- 2). Focal length: 1000 mm
- 3). Grating specification: Holographic ion beam etched grating, Number of grooves: 3600 grooves/mm  
Area of grooves:  $(80 \times 110)$  mm  
(Optional grating with number of grooves: 2400 grooves/mm and area of grooves:  $80 \times 110$ )
- 4). Reciprocal linear dispersion:  $0.26\text{nm/mm}$
- 5). Resolution:  $\leq 0.008\text{nm}$
- 6). Wavelength range:
  - 3600 grooves/mm for 195 to 500nm
  - 2400 grooves/mm for 195 to 800nm
- 7). Minimum step wavelength:  $0.0006\text{nm}$
- 8). Exit, entrance slits:  $20\mu\text{m}$
- 9). Reflector:  $(78 \times 105 \times 16)\text{mm}$
- 10). Transmission mirror:  $\phi 30, 1:1$  imaging
- 11). Temperature control:  $32^\circ\text{C} \pm 1^\circ\text{C}$

[www.skyray-instrument.com](http://www.skyray-instrument.com) / [www.gold-tester.com](http://www.gold-tester.com)

### Photoelectric Conversion Device:

- 1). Photomultiplier specifications: R212UH or R928
- 2). Negative HV power supply of photomultiplier: 200-1000V  
Stability:  $< 0.05\%$
- 3). Measurement range of photomultiplier current:  $1\text{nA} - 100\mu\text{A}$
- 4). Signal collection is in V/F transfer:  $1\text{mV}$  corresponds to 100Hz

## Photoelectric Conversion Device

Precise control circuit and electronic measuring system includes Communication Interfaces System, Photomultiplier HV Power Supply and Control, Step Motor Control, and Signal Collection. The photomultiplier and components in use are new and high sensitive with wide strength range. The signal sampling is V/F convertering, which has wide range of the sample content, high sensitivity and exceptional stability.

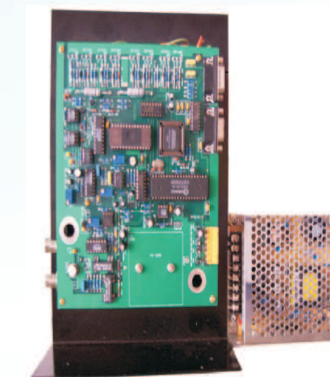

▲ Electronic control board

## Personal computer

### Personal computer configurations:

- 1). Brand name: FOUNDER Memory : 512MB Hard disc: 80GB
- 2). Display: 17-inch TFT LCD
- 3). Printer: Panasonic KX-P1121 24-pin printer

### Functions of software

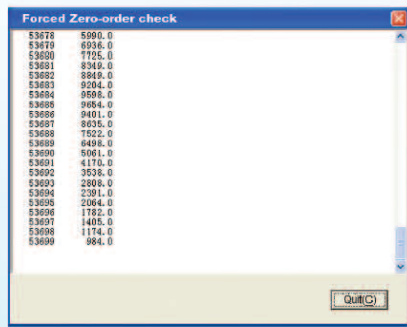

Zero-order searching is the foundation of preparing the instrument for measurement positioning. You are suggested to perform a calibration using a blank to determine the mechanical zero point every time the instrument is turned on.

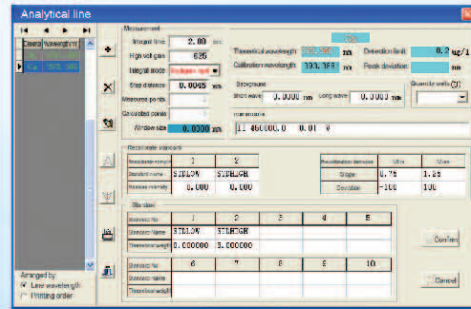

To develop methods, select the element of interest from the Periodic Table of Elements on the method interface according to its type after the program is started and select the line of the element.

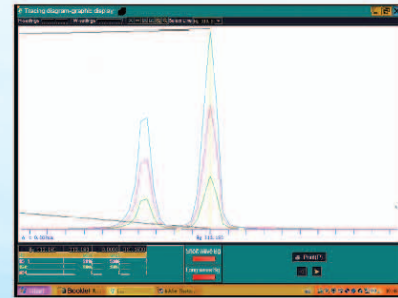

The spectrum analysis mode performs auto peak searching of the added spectrum with the help of the software. When several peaks coexist, the users can manually identify the peak so as to eliminate the interference produced by elements other than the tested one.

## Test example

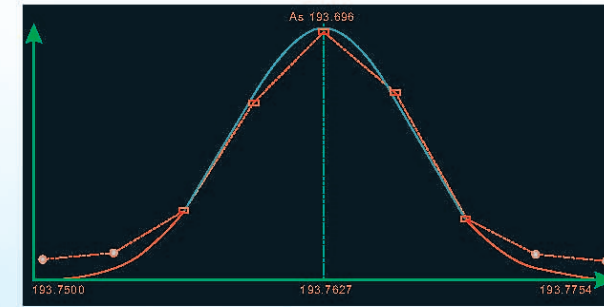

Spectrum of As in waste water



Industrial waste water

Element	Wavelength	Sample content	Relative deviation
As	193.696	5.03 ppm	0.54%
As	228.812	5.03 ppm	0.44%
As	234.984	5.05 ppm	0.15%
As	278.022	5.00 ppm	0.31%

Test results of As

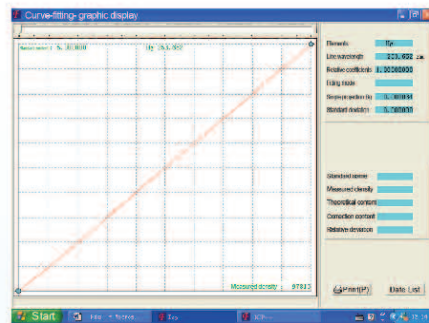

Prepare work curve

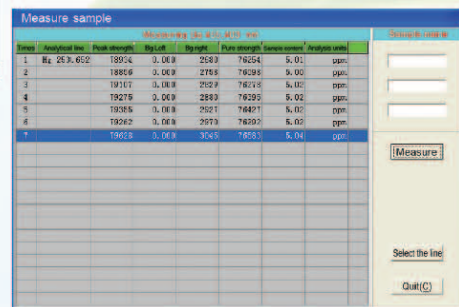

For sample measurement, the concentration units are in % or ppm or  $\mu\text{g/ml}$ .

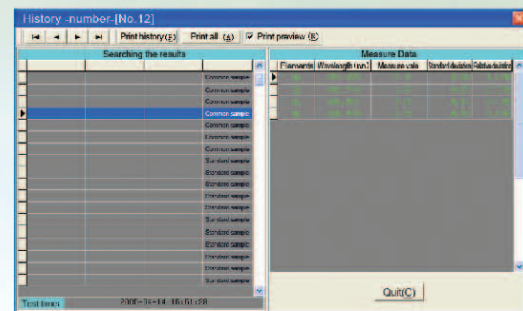

Data and results can be printed out or saved in copies.

[www.skyray-instrument.com](http://www.skyray-instrument.com) / [www.gold-tester.com](http://www.gold-tester.com)

## ICP-2000 Measurable elements and detection limits

