



WWW.ORACLESTORAGE.CO.UK

UNIT 3 GALAXY HOUSE, NEW GREENHAM PARK,
NEWBURY, BERKSHIRE. RG19 6HW

TEL: 01635 32032
WWW.ORACLESTORAGE.CO.UK
WWW.MOBILESHELVING.ORG.UK
WWW.MEZZANINEFLOORS.UK.COM

STORAGE HANDLING SOLUTIONS
2010 PRICE LIST

STORAGE HANDLING SOLUTIONS - 2010 PRICE LIST



Oracle
Storage Systems



WWW.ORACLESTORAGE.CO.UK

STORAGE HANDLING SOLUTIONS
2010 PRICE LIST

SMALL PARTS STORAGE

We offer simple but effective small parts storage systems designed to cater for a wide range of materials and applications.

| Product | Lead Time (Working Days) | Page |
|---|-----------------------------|------|
| Topstore - TC Semi-Open Fronted Containers | (5) | 4 |
| Topstore - Electro Conductive Storage Containers | (5) | 5 |
| Topstore - NXT-GEN Semi-Open Fronted Stack & Nest Containers | (5) | 6 |
| Topstore - Wall Mounted Louvred Panels | (5) | 8 |
| Topstore - Wall Mounted Louvred Panel Kits. | (5) | 10 |
| Topstore - Mesh Basket Louvred Panel Kits | (5) | 13 |
| Topstore - Louvred Panel Spacemasters | (7) | 14 |
| Topstore - Louvred Panel Trolleys | (7) | 16 |
| Topstore - Bench Top Carousels, Bench Stands & Mesh Baskets | (5) | 18 |
| Topstore - Louvred Panel Spigots | (5) | 19 |
| Topstore - Fully Boxed Bin Kits | (10) | 19 |
| Topstore - Shelf Bins | (5) | 20 |
| Topstore - Economy Shelf Bins | (5) | 21 |
| Topstore - Shelf Bin Cabinets | (7-10) | 21 |
| Topstore - Container Cabinets | (7-10) | 22 |
| Topdrawer - Small Parts Cabinets and Trolley | (5-7) | 24 |
| Topstore - Clearbox, Floor Stands, Trolleys & Wall Units | (5) | 26 |
| Topstore - Visibins & Bench Stands | (5) | 28 |
| Topstore - Visibins Trolley & Wall Grids | (7) | 29 |
| Topstore - Space Bin Containers & Topbox | (5) | 30 |
| Topstore - Multi-functional Containers & Blue Plastic Dolly | (5) | 31 |
| Topstore - Euro Containers | (5) | 32 |
| Topstore - Clearbox Flex-bins & Clearbox Mini-bins. | (5) | 34 |
| Topstore - Flexi Store | (5-7) | 35 |
| Topstore - Container Trolleys | (7) | 37 |
| Topstore - Euro Container Tray Trolleys | (7) | 40 |

Topstore - TC Semi-Open Fronted Containers

A simple and effective small parts storage system for a wide range of materials. Space saving, manufactured from polypropylene, can be stacked or for increased flexibility, used with Topstore Louvred Panels, Cabinets and Shelving.

A comprehensive range, available in 7 sizes and 6 colours as standard. Containers can be manufactured in own brand and colours for high volume users.

Features:

- Injection moulded with anti-static additive and non-fade ultra violet stabiliser
- Strong, heavy duty with reinforced base, sides and stacking rim
- Durable, resistant to most industrial solvents and can withstand high temperatures
- Hygienic, clean, smooth inside faces guard against build up of grease etc
- Non-toxic, suitable for use with foodstuffs
- Index card slot for instant product identification



TC Containers in Sizes TC1-7



Stackable Containers



Bin Front for TC 7

Clear plastic bin front enables full utilisation of the bin whilst protecting the contents from dust etc. Easily opens/closes when bins are stacked.

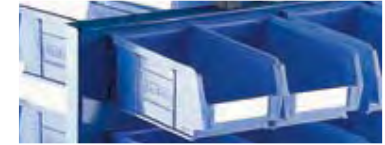
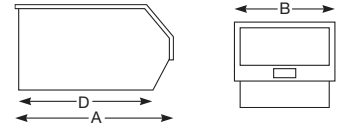

| | TC1 | TC2 | TC3 | TC4 | TC5 | TC6 | TC7 |
|--|--|--------|--------|---------|---------|---------|--------|
| Overall Length mm (A) | 90 | 165 | 240 | 350 | 350 | 375 | 520 |
| Overall Width mm (B) | 100 | 100 | 150 | 205 | 205 | 420 | 310 |
| Overall Height mm (C) | 50 | 75 | 132 | 132 | 182 | 182 | 200 |
| Overall Base Length mm (D) | 64 | 143 | 200 | 300 | 300 | 310 | 450 |
| Volume (Litres) | 0.46 | 1.27 | 4.6 | 9.1 | 12.8 | 28.3 | 31.4 |
| Max. Load Cap. (Kg) on Louvred Panel (Based upon Louvred Panels in this publication) | 8 | 8 | 20 | 24 | 30 | 40 | 28 |
| Louvre Calculator | Please see page 9 for container/louvre panel configuration | | | | | | |
| No of containers per carton | 20 | 20 | 10 | 10 | 10 | 5 | 5 |
| Blue Order Ref | 010011 | 010021 | 010031 | 010041 | 010051 | 010061 | 010071 |
| Red Order Ref | 010012 | 010022 | 010032 | 010042 | 010052 | 010062 | 010072 |
| Green Order Ref | 010014 | 010024 | 010034 | 010044 | 010054 | 010064 | 010074 |
| Yellow Order Ref | 010016 | 010026 | 010036 | 010046 | 010056 | 010066 | 010076 |
| Price per Carton | £15.43 | £26.05 | £30.87 | £51.44 | £78.41 | £67.21 | £82.14 |
| White Order Ref | 010017 | 010027 | 010037 | 010047 | 010057 | 010067 | 010077 |
| Price per Carton | £15.03 | £25.03 | £29.60 | £49.32 | £75.27 | £64.00 | £78.67 |
| Black Conductive Order Ref | 010019 | 010029 | 010039 | 010049 | 010059 | 010069 | - |
| Price per Carton | £29.54 | £60.81 | £75.39 | £128.44 | £203.93 | £188.18 | N/A |

| BULK | TC1 | TC2 | TC3 | TC4 | TC5 | TC6 | TC7 |
|--------------------------|-----|-------------|------------|------------|------------|------------|-----------|
| No of cartons per pallet | N/A | 90 | 54 | 25 | 20 | 20 | 16 |
| Blue Bulk Order Ref | N/A | 010021/1800 | 010031/540 | 010041/250 | 010051/200 | 010061/100 | 010071/80 |
| Red Bulk Order Ref | N/A | 010022/1800 | 010032/540 | 010042/250 | 010052/200 | 010062/100 | 010072/80 |
| Green Bulk Order Ref | N/A | 010024/1800 | 010034/540 | 010044/250 | 010054/200 | 010064/100 | 010074/80 |
| Yellow Bulk Order Ref | N/A | 010026/1800 | 010036/540 | 010046/250 | 010056/200 | 010066/100 | 010076/80 |
| Price per Pallet | N/A | £1,775.39 | £1,261.99 | £973.76 | £1,187.36 | £1,017.74 | £995.12 |
| White Bulk Order Ref | N/A | 010027/1800 | 010037/540 | 010047/250 | 010057/200 | 010067/100 | 010077/80 |
| Price per Pallet | N/A | £1,705.28 | £1,198.89 | £924.72 | £1,129.06 | £959.94 | £944.06 |

| | | | | | | | |
|-----------------------------|--------|--------|--------|--------|--------|--------|--------|
| Additional Labels Order Ref | 010010 | 010020 | 010020 | 010020 | 010020 | 010020 | 010030 |
| Price per Pack of 100 | £1.79 | £1.89 | £1.89 | £1.89 | £1.89 | £1.89 | £6.69 |
| Bin Fronts Order Ref | - | - | - | - | - | - | 010080 |
| Price of Each | N/A | N/A | N/A | N/A | N/A | N/A | £5.05 |

N.B. Prices include 1 - I.D. label per bin

Topstore - Black Conductive Storage Containers
For the safe storage of static sensitive components.

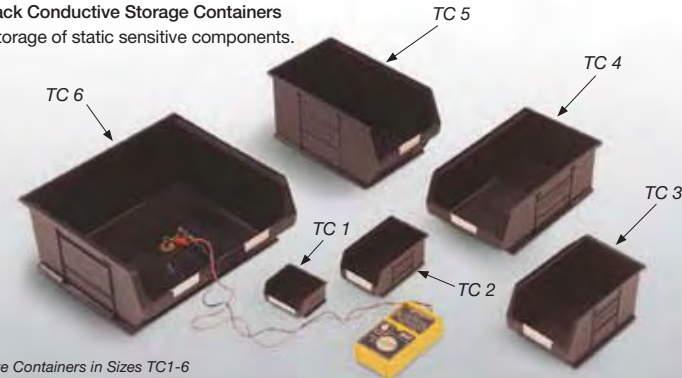

Black Conductive Containers in Sizes TC1-6

Topstore - NXT-GEN Semi-Open Fronted Stack & Nest Containers

The all new next generation storage containers are designed to help you make the most of the space in your business.

Manufactured from polypropylene, the NXT-GEN container combines the quality that you have come to expect with tomorrow's cutting edge technology. Its revolutionary new design enables the bin to stack and nest, with the facility to be mounted onto louvred panels and to hold dividers to make the best possible use of the space available. NXT-GEN containers are also designed to be used with our cabinets and shelving systems to make this one of the most flexible bins available.

Available in 7 sizes and 3 colours as standard. Containers can be manufactured in own brand and colours for high volume users.

Features:

- Dividers available to run front to back or left to right dependent on bin size
- When not in use, the bins will nest reducing the amount of storage space required
- Resistant to most chemicals, including oil and acids as well as withstanding high temperatures
- Non-toxic polypropylene is suitable for use with many foodstuffs
- Increased clear access facilities for easy selection
- Ergonomic design generates greater durability and strength
- Lifting handle on larger bins
- Index card slot for instant product identification
- Injection moulded with anti-static additive and non-fade ultra violet stabiliser



NXT-GEN Containers in Sizes NXT 1-7

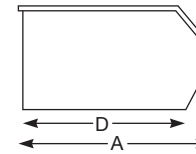

Dividers for NXT-GEN Containers

| | NXT1 | NXT2 | NXT3 | NXT4 | NXT5 | NXT6 | NXT7 |
|---|--|----------|----------|----------|----------|----------|----------|
| Overall Length mm (A) | 103 | 172 | 250 | 355 | 355 | 385 | 510 |
| Overall Width mm (B) | 100 | 109 | 179 | 240 | 240 | 470 | 335 |
| Overall Height mm (C) | 50 | 80 | 130 | 130 | 180 | 180 | 246 |
| Overall Base Length mm (D) | 83 | 135 | 205 | 313 | 303 | 316 | 410 |
| Volume (Litres) | 0.37 | 0.90 | 3.87 | 7.49 | 9.74 | 21.01 | 27.11 |
| Louvre Calculator | Please see page 9 for container/louvre panel configuration | | | | | | |
| Max Load Capacity (Kg) on Louvred Panel (Based upon Louvred Panels in this publication) | 8 | 8 | 20 | 24 | 30 | 40 | 28 |
| No of containers per carton | 20 | 20 | 10 | 10 | 10 | 2 | 2 |
| Blue Order Ref | 010011SN | 010021SN | 010031SN | 010041SN | 010051SN | 010061SN | 010071SN |
| Red Order Ref | 010012SN | 010022SN | 010032SN | 010042SN | 010052SN | 010062SN | 010072SN |
| Price per Carton | £19.10 | £30.16 | £38.70 | £64.16 | £87.11 | £27.47 | £36.02 |
| White Order Ref | 010017SN | 010027SN | 010037SN | 010047SN | 010057SN | 010067SN | 010077SN |
| Price per Carton | £18.61 | £28.95 | £36.76 | £60.92 | £82.83 | £25.94 | £34.40 |
| Dividers Front to Back - Order Ref | N/A | N/A | N/A | 010048FB | 010058FB | 010068FB | 010078FB |
| Pack Size | | | | 10 | 10 | 5 | 5 |
| Price Per Pack | | | | £33.19 | £33.19 | £16.59 | £16.59 |
| Dividers Left to Right - Order Ref | N/A | N/A | 010038LR | 010048LR | 010058LR | N/A | 010078LR |
| Pack Size | | | 10 | 10 | 10 | | 10 |
| Price Per Pack | | | £33.19 | £33.19 | £33.19 | | £33.19 |
| Additional ID Labels Order Ref | 010010SN | 010020SN | 010030SN | 010040SN | 010050SN | 010060SN | 010070SN |
| Price per Pack of 100 | £7.27 | £4.60 | £4.67 | £10.02 | £7.42 | £7.42 | £7.42 |

N.B. Prices include 1 - I.D. label per bin

Typical Applications



Topstore - Wall Mounted Louvred Panels

Featuring the unique double indented louvre for extra strength, this system offers the ideal solution for wall mounting and many other applications for NXT-GEN and Topstore TC containers and accessories.

7 Imperial and 4 metric sizes available. Precision formed and finished epoxy powder coated in two colours.



| BLUE METRIC | 500mm Wide | | | | 1000mm Wide | | | | Height | |
|----------------|------------|-----|-----------|--------------|-------------|-----|-----------|--------------|--------|------|
| | TMP Ref | NL | Order Ref | Price (Each) | TMP Ref | NL | Order Ref | Price (Each) | Inches | mm |
| | 5 | 60 | 010165NXT | £16.77 | 7 | 120 | 010167NXT | £27.12 | 19.75 | 500 |
| | 6 | 120 | 010166NXT | £26.60 | 8 | 240 | 010168NXT | £53.95 | 39.37 | 1000 |

| GREY IMPERIAL | 457mm (18") Wide | | | | 914mm (36") Wide | | | | Height | |
|------------------|------------------|-----|-----------|--------------|------------------|-----|-----------|--------------|--------|------|
| | TP Ref | NL | Order Ref | Price (Each) | TP Ref | NL | Order Ref | Price (Each) | Inches | mm |
| | 1 | 48 | 010101 | £13.85 | 5 | 96 | 010105 | £25.93 | 17.25 | 438 |
| | 10 | 72 | 010110 | £18.80 | - | - | - | - | 25.25 | 641 |
| | 2 | 108 | 010102 | £25.97 | 6 | 216 | 010106 | £48.15 | 37.25 | 946 |
| | 3 | 180 | 010103 | £39.45 | - | - | - | - | 61.25 | 1556 |
| | 4 | 216 | 010104 | £47.85 | - | - | - | - | 73.25 | 1861 |



Excludes wall fixings

Louvre Value Configuration

- To calculate approximately the amount of NXT-GEN or TC Containers or accessories that can be accommodated on a Topstore Louvred Panel, or part thereof, take the LV (Louvre Value) of the container or accessory and divide it in to the NL (Number of Louvres) per panel. To determine the number/size of Louvred Panels required to locate specific quantities of containers, simply reverse the above process.
- To calculate the exact configuration, see diagram below.

TC Containers are suitable for both the metric blue and imperial grey louvred panels, however the NXT-GEN Containers are better suited to the metric blue louvred panels.

| IMPERIAL LOUVRED PANELS | | | |
|-------------------------|------------------------------|--------------------|--------|
| Panel Ref: | Total (NL) No. of Louvres | No. of Louvres in: | |
| | | Width | Height |
| TP1 | 48 | 6 | 8 |
| TP10 | 72 | 6 | 12 |
| TP2 | 108 | 6 | 18 |
| TP3 | 180 | 6 | 30 |
| TP4 | 216 | 6 | 36 |
| TP5 | 96 | 12 | 8 |
| TP6 | 216 | 12 | 18 |

| METRIC LOUVRED PANELS | | | |
|-----------------------|------------------------------|--------------------|--------|
| Panel Ref: | Total (NL) No. of Louvres | No. of Louvres in: | |
| | | Width | Height |
| TMP5 | 60 | 6 | 10 |
| TMP6 | 120 | 6 | 20 |
| TMP7 | 120 | 12 | 10 |
| TMP8 | 240 | 12 | 20 |

| Container | No. of Louvres in: | | | TP4 Louvred Panel shown below |
|-----------|--------------------|--------|----------------------------|----------------------------------|
| | Width | Height | Total (LV) Louvre Value | |
| TC1 | 1.5 | 1 | 1.5 | |
| TC2 | 1.5 | 2 | 3 | |
| TC3 | 2 | 3 | 6 | |
| TC4 | 3 | 3 | 9 | |
| TC5 | 3 | 4 | 12 | |
| TC6 | 6 | 4 | 24 | |
| TC7 | 4 | 4 | 16 | |

| Container | No. of Louvres in: | | | 2 x TMP6 Louvred Panels shown below |
|---|--------------------|--------|----------------------------|--|
| | Width | Height | Total (LV) Louvre Value | |
| NXT1 | 1.5 | 1 | 1.5 | |
| NXT2 | 1.5 | 2 | 3 | |
| NXT3 | 3 | 3 | 9 | |
| Note: 5 NXT3 containers can fit in width on a 1000mm wide Louvred Panel | | | | |
| NXT4 | 3 | 3 | 9 | |
| NXT5 | 3 | 4 | 12 | |
| NXT6 | 6 | 4 | 24 | |
| NXT7 | 4 | 5 | 20 | |
| Note: 3 NXT7 containers can fit in width on a 1000mm wide Louvred Panel | | | | |

Topstore - Wall Mounted Louvred Panel Kits

A range of modular pre-kitted TP10 louvred panels (H) 641 x (W) 457 mm in grey, complete with Topstore Containers ranging from TC2's to TC6's, in blue or red. For all other bin sizes and colours, see pages 4 and 5 and louvre panels see pages 8 and 9. (Other standard colours are available upon request).

- All kits exclude wall fixings

N.B. Prices include 1 - I.D. label per bin

Topstore - 1 Panel high x 2 Panels wide (H 641 x W 914mm) TC Bin Kits

| Containers Included | Order Ref | Containers Included | Order Ref | No. of Louvred Panels per Kit | Price (Each) |
|---------------------|-----------|---------------------|-----------|-------------------------------|--------------|
| 48 x TC2 Blue Bins | 010205B | 48 x TC2 Red Bins | 010205R | 2 | £69.85 |
| 24 x TC3 Blue Bins | 010206B | 24 x TC3 Red Bins | 010206R | 2 | £75.68 |
| 16 x TC4 Blue Bins | 010207B | 16 x TC4 Red Bins | 010207R | 2 | £79.83 |
| 12 x TC5 Blue Bins | 010208B | 12 x TC5 Red Bins | 010208R | 2 | £85.78 |
| 6 x TC6 Blue Bins | 010209B | 6 x TC6 Red Bins | 010209R | 2 | £79.00 |

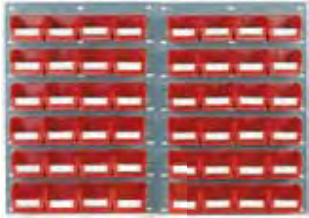

010205R - TC2 Red

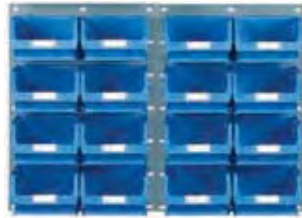

010207B - TC4 Blue

Topstore - 1 Panel high x 3 Panels wide (H 641 x W 1371mm) TC Bin Kits

| Containers Included | Order Ref | Containers Included | Order Ref | No. of Louvred Panels per Kit | Price (Each) |
|---------------------|-----------|---------------------|-----------|-------------------------------|--------------|
| 72 x TC2 Blue Bins | 010210B | 72 x TC2 Red Bins | 010210R | 3 | £104.77 |
| 36 x TC3 Blue Bins | 010211B | 36 x TC3 Red Bins | 010211R | 3 | £113.52 |
| 24 x TC4 Blue Bins | 010212B | 24 x TC4 Red Bins | 010212R | 3 | £119.75 |
| 18 x TC5 Blue Bins | 010213B | 18 x TC5 Red Bins | 010213R | 3 | £128.67 |
| 9 x TC6 Blue Bins | 010214B | 9 x TC6 Red Bins | 010214R | 3 | £118.50 |



010211R - TC3 Red



010214B - TC6 Blue

Topstore - 1 Panel high x 4 Panels wide (H 641 x W 1828mm) TC Bin Kits

| Containers Included | Order Ref | Containers Included | Order Ref | No. of Louvred Panels per Kit | Price (Each) |
|---------------------|-----------|---------------------|-----------|-------------------------------|--------------|
| 96 x TC2 Blue Bins | 010215B | 96 x TC2 Red Bins | 010215R | 4 | £139.70 |
| 48 x TC3 Blue Bins | 010216B | 48 x TC3 Red Bins | 010216R | 4 | £151.36 |
| 32 x TC4 Blue Bins | 010217B | 32 x TC4 Red Bins | 010217R | 4 | £159.67 |
| 24 x TC5 Blue Bins | 010218B | 24 x TC5 Red Bins | 010218R | 4 | £171.56 |
| 12 x TC6 Blue Bins | 010219B | 12 x TC6 Red Bins | 010219R | 4 | £157.99 |



010216R - TC3 Red



010218B - TC5 Blue

Topstore - 2 Panels high x 1 Panel wide (H 1282 x W 457mm) TC Bin Kits

| Containers Included | Order Ref | Containers Included | Order Ref | No. of Louvred Panels per Kit | Price (Each) |
|---------------------|-----------|---------------------|-----------|-------------------------------|--------------|
| 48 x TC2 Blue Bins | 010205B | 48 x TC2 Red Bins | 010205R | 2 | £69.85 |
| 24 x TC3 Blue Bins | 010206B | 24 x TC3 Red Bins | 010206R | 2 | £75.68 |
| 16 x TC4 Blue Bins | 010207B | 16 x TC4 Red Bins | 010207R | 2 | £79.83 |
| 12 x TC5 Blue Bins | 010208B | 12 x TC5 Red Bins | 010208R | 2 | £85.78 |
| 6 x TC6 Blue Bins | 010209B | 6 x TC6 Red Bins | 010209R | 2 | £79.00 |



010206R - TC3 Red



010208B - TC5 Blue



010209R - TC6 Red

Topstore - 2 Panels high x 2 Panels wide (H 1282 x W 914mm) TC Bin Kits

| Containers Included | Order Ref | Containers Included | Order Ref | No. of Louvred Panels per Kit | Price (Each) |
|---------------------|-----------|---------------------|-----------|-------------------------------|--------------|
| 96 x TC2 Blue Bins | 010215B | 96 x TC2 Red Bins | 010215R | 4 | £139.70 |
| 48 x TC3 Blue Bins | 010216B | 48 x TC3 Red Bins | 010216R | 4 | £151.36 |
| 32 x TC4 Blue Bins | 010217B | 32 x TC4 Red Bins | 010217R | 4 | £159.67 |
| 24 x TC5 Blue Bins | 010218B | 24 x TC5 Red Bins | 010218R | 4 | £171.56 |
| 12 x TC6 Blue Bins | 010219B | 12 x TC6 Red Bins | 010219R | 4 | £157.99 |

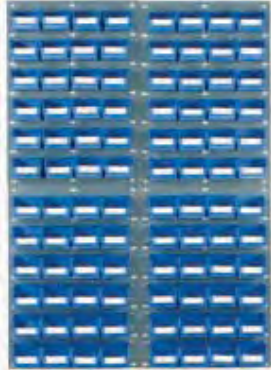

010215B - TC2 Blue



010218R - TC5 Red

Topstore - 2 Panels high x 3 Panels wide (H 1282 x W 1371mm) TC Bin Kits

| Containers Included | Order Ref | Containers Included | Order Ref | No. of Louvred Panels per Kit | Price (Each) |
|---------------------|-----------|---------------------|-----------|-------------------------------|--------------|
| 144 x TC2 Blue Bins | 010220B | 144 x TC2 Red Bins | 010220R | 6 | £209.55 |
| 72 x TC3 Blue Bins | 010221B | 72 x TC3 Red Bins | 010221R | 6 | £227.04 |
| 48 x TC4 Blue Bins | 010222B | 48 x TC4 Red Bins | 010222R | 6 | £239.50 |
| 36 x TC5 Blue Bins | 010223B | 36 x TC5 Red Bins | 010223R | 6 | £257.34 |
| 18 x TC6 Blue Bins | 010224B | 18 x TC6 Red Bins | 010224R | 6 | £236.99 |



010223R - TC5 Red



010224B - TC6 Blue

Topstore - 2 Panels high x 4 Panels wide (H 1282 x W 1828mm) TC Bin Kits

| Containers Included | Order Ref | Containers Included | Order Ref | No. of Louvred Panels per Kit | Price (Each) |
|---------------------|-----------|---------------------|-----------|-------------------------------|--------------|
| 192 x TC2 Blue Bins | 010225B | 192 x TC2 Red Bins | 010225R | 8 | £279.40 |
| 96 x TC3 Blue Bins | 010226B | 96 x TC3 Red Bins | 010226R | 8 | £302.72 |
| 64 x TC4 Blue Bins | 010227B | 64 x TC4 Red Bins | 010227R | 8 | £319.34 |
| 48 x TC5 Blue Bins | 010228B | 48 x TC5 Red Bins | 010228R | 8 | £343.13 |
| 24 x TC6 Blue Bins | 010229B | 24 x TC6 Red Bins | 010229R | 8 | £315.99 |



010226B - TC3 Blue



010227R - TC4 Red

Topstore - Mesh Basket Louvred Panel Kits

Some additional modular pre-kitted TP2 Louvred Panels (H) 946 x (W) 457mm in grey, complete with either small or large mesh baskets. For full basket sizes and divider options, please refer to page 18.

| Baskets Included | H x W (mm) | Order Ref | No. of Louvred Panels per Kit | Price (Each) |
|-------------------------|------------|-----------|-------------------------------|--------------|
| 3 x Small Mesh Baskets | 946 x 457 | 010230SB | 1 | £151.63 |
| 6 x Small Mesh Baskets | 946 x 914 | 010231SB | 2 | £303.26 |
| 9 x Small Mesh Baskets | 946 x 1371 | 010232SB | 3 | £454.88 |
| 12 x Small Mesh Baskets | 946 x 1828 | 010233SB | 4 | £606.51 |
| 3 x Large Mesh Baskets | 946 x 457 | 010234LB | 1 | £167.65 |
| 6 x Large Mesh Baskets | 946 x 914 | 010235LB | 2 | £335.31 |
| 9 x Large Mesh Baskets | 946 x 1371 | 010236LB | 3 | £502.96 |
| 12 x Large Mesh Baskets | 946 x 1828 | 010237LB | 4 | £670.62 |



010231SB



010236LB

Topstore - Louvred Panel Spacemasters

Single or double sided freestanding storage units available in 3 heights for increased storage capacity when using both NXT-GEN and TC Topstore containers and accessories.

Units are finished epoxy powder coated blue with silver/grey base.

For larger applications order one "starter" and the appropriate number of "addas" to make this a complete solution to suit individual requirements.

Heavy duty adjusters permit levelling on uneven surfaces.

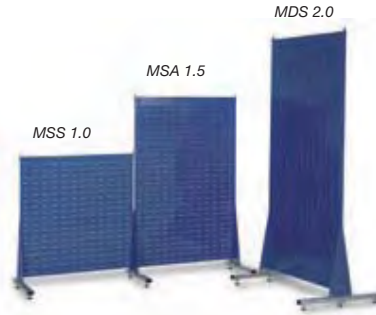

Topstore - Spacemaster Stands Only

| Racks (Excluding Containers) - Single Sided | | | | | | | | |
|---|-----------|--------------|----------|-----------|--------------|-----|-------------------|----------|
| Starter Ref | Order Ref | Price (Each) | Adda Ref | Order Ref | Price (Each) | NL | H x W x D (mm) | Capacity |
| MSS 1.0 | 010810NXT | £174.15 | MSA 1.0 | 010820NXT | £145.91 | 240 | 1100 x 1000 x 500 | 400 kgs |
| MSS 1.5 | 010830NXT | £199.08 | MSA 1.5 | 010840NXT | £170.85 | 360 | 1600 x 1000 x 500 | 400 kgs |
| MSS 2.0 | 010850NXT | £243.38 | MSA 2.0 | 010860NXT | £215.14 | 480 | 2100 x 1000 x 500 | 400 kgs |

| Racks (Excluding Containers) - Double Sided | | | | | | | | |
|---|-----------|--------------|----------|-----------|--------------|-----|-------------------|----------|
| Starter Ref | Order Ref | Price (Each) | Adda Ref | Order Ref | Price (Each) | NL | H x W x D (mm) | Capacity |
| MDS 1.0 | 010910NXT | £250.83 | MDA 1.0 | 010920NXT | £211.02 | 480 | 1100 x 1000 x 750 | 800 kgs |
| MDS 1.5 | 010930NXT | £300.73 | MDA 1.5 | 010940NXT | £260.92 | 720 | 1600 x 1000 x 750 | 800 kgs |
| MDS 2.0 | 010950NXT | £355.57 | MDA 2.0 | 010960NXT | £315.76 | 960 | 2100 x 1000 x 750 | 800 kgs |

(Note: NL= number of louvres, please refer to page 9)

Topstore - Louvred Panel Spacemasters NXT-Gen Bin Kits

| Product Description | Order Ref | H x W x D (mm) | Containers Included | Price (Each) |
|--|-----------|-------------------|--------------------------------|--------------|
| Single Sided (Starter) Spacemaster Kit | 011521NXT | 1600 x 1000 x 500 | 54 x NXT2 Red & 30 x NXT3 Blue | £299.02 |
| Single Sided (Starter) Spacemaster Kit | 011522NXT | 1600 x 1000 x 500 | 63 x NXT2 Red & 72 x NXT2 Blue | £329.42 |
| Single Sided (Starter) Spacemaster Kit | 011523NXT | 1600 x 1000 x 500 | 25 x NXT3 Red & 25 x NXT3 Blue | £295.83 |

| Product Description | Order Ref | H x W x D (mm) | Containers Included | Price (Each) |
|--|-----------|-------------------|----------------------------------|--------------|
| Double Sided (Starter) Spacemaster Kit | 011531NXT | 1600 x 1000 x 750 | 108 x NXT2 Red & 60 x NXT3 Blue | £498.25 |
| Double Sided (Starter) Spacemaster Kit | 011532NXT | 1600 x 1000 x 750 | 126 x NXT2 Red & 144 x NXT2 Blue | £555.20 |
| Double Sided (Starter) Spacemaster Kit | 011533NXT | 1600 x 1000 x 750 | 50 x NXT3 Red & 50 x NXT3 Blue | £494.23 |

N.B. Prices include 1 - I.D. label per bin



Topstore - Louvred Panel Spacemasters TC Bin Kits

MSS1.5 Spacemaster Single Sided Starter Kits

| Containers Included | Order Ref | Containers Included | Order Ref | Containers Included | Order Ref | Price (Each) |
|------------------------------|-----------|---------------------|-----------|---------------------|-----------|--------------|
| 64 x TC2 Red & 56 x TC2 Blue | 011514A | 120 x TC2 Red | 011514B | 120 x TC2 Blue | 011514C | £331.20 |
| 30 X TC3 Red & 30 x TC3 Blue | 011516A | 60 x TC3 Red | 011516B | 60 x TC3 Blue | 011516C | £292.56 |
| 20 x TC4 Red & 20 x TC4 Blue | 011518A | 40 x TC4 Red | 011518B | 40 x TC4 Blue | 011518C | £302.95 |
| 16 x TC5 Red & 12 x TC5 Blue | 011520A | 28 x TC5 Red | 011520B | 28 x TC5 Blue | 011520C | £325.73 |
| 8 x TC6 Red & 6 x TC6 Blue | 011522A | 14 x TC6 Red | 011522B | 14 x TC6 Blue | 011522C | £294.07 |

Dimensions for above models: (H) 1600 x (W) 1000 x (D) 500mm

MSA1.5 Spacemaster Single Sided Adda Kits

| Containers Included | Order Ref | Containers Included | Order Ref | Containers Included | Order Ref | Price (Each) |
|------------------------------|-----------|---------------------|-----------|---------------------|-----------|--------------|
| 64 x TC2 Red & 56 x TC2 Blue | 011515A | 120 x TC2 Red | 011515B | 120 x TC2 Blue | 011515C | £315.80 |
| 30 X TC3 Red & 30 x TC3 Blue | 011517A | 60 x TC3 Red | 011517B | 60 x TC3 Blue | 011517C | £264.33 |
| 20 x TC4 Red & 20 x TC4 Blue | 011519A | 40 x TC4 Red | 011519B | 40 x TC4 Blue | 011519C | £280.80 |
| 16 x TC5 Red & 12 x TC5 Blue | 011521A | 28 x TC5 Red | 011521B | 28 x TC5 Blue | 011521C | £297.50 |
| 8 x TC6 Red & 6 x TC6 Blue | 011523A | 14 x TC6 Red | 011523B | 14 x TC6 Blue | 011523C | £265.83 |

Dimensions for above models: (H) 1600 x (W) 1000 x (D) 500mm



MDS1.5 Spacemaster Double Sided Starter Kits

| Containers Included | Order Ref | Containers Included | Order Ref | Containers Included | Order Ref | Price (Each) |
|--------------------------------|-----------|---------------------|-----------|---------------------|-----------|--------------|
| 128 x TC2 Red & 112 x TC2 Blue | 011524A | 240 x TC2 Red | 011524B | 240 x TC2 Blue | 011524C | £568.40 |
| 60 x TC3 Red & 60 x TC3 Blue | 011526A | 120 x TC3 Red | 011526B | 120 x TC3 Blue | 011526C | £487.69 |
| 40 x TC4 Red & 40 x TC4 Blue | 011528A | 80 x TC4 Red | 011528B | 80 x TC4 Blue | 011528C | £508.47 |
| 32 x TC5 Red & 24 x TC5 Blue | 011530A | 56 x TC5 Red | 011530B | 56 x TC5 Blue | 011530C | £554.04 |
| 16 x TC6 Red & 12 x TC6 Blue | 011532A | 28 x TC6 Red | 011532B | 28 x TC6 Blue | 011532C | £490.71 |

Dimensions for above models: (H) 1600 x (W) 1000 x (D) 750mm

MDA1.5 Spacemaster Double Sided Adda Kits

| Containers Included | Order Ref | Containers Included | Order Ref | Containers Included | Order Ref | Price (Each) |
|--------------------------------|-----------|---------------------|-----------|---------------------|-----------|--------------|
| 128 x TC2 Red & 112 x TC2 Blue | 011525A | 240 x TC2 Red | 011525B | 240 x TC2 Blue | 011525C | £544.80 |
| 60 x TC3 Red & 60 x TC3 Blue | 011527A | 120 x TC3 Red | 011527B | 120 x TC3 Blue | 011527C | £451.10 |
| 40 x TC4 Red & 40 x TC4 Blue | 011529A | 80 x TC4 Red | 011529B | 80 x TC4 Blue | 011529C | £469.60 |
| 32 x TC5 Red & 24 x TC5 Blue | 011531A | 56 x TC5 Red | 011531B | 56 x TC5 Blue | 011531C | £514.23 |
| 16 x TC6 Red & 12 x TC6 Blue | 011533A | 28 x TC6 Red | 011533B | 28 x TC6 Blue | 011533C | £450.90 |

Dimensions for above models: (H) 1600 x (W) 1000 x (D) 750mm

N.B. Prices include 1 - I.D. label per bin

Topstore - Louvred Panel Trolleys

When you require a solution for component picking in aisles or requiring movement, we offer a range of trolleys compatible with both NXT-GEN and Topstore TC Containers and Accessories.

Units are finished epoxy powder coated blue with silver/grey base.

The trolleys are supplied as standard with 100mm diameter wheels/castors (2 fixed/2 swivel) non-marking rubber tyred and enable a safe load to be manoeuvred with ease.

Topstore - Trolley Stands Only

| Trolley Stands Only (Excluding Containers) | | | | | | |
|--|------|-----|---------------|-------------------|-----------|--------------|
| | Ref | NL | Capacity (Kg) | H x W x D (mm) | Order Ref | Price (Each) |
| Single | MTS4 | 240 | 125 | 1160 x 1000 x 530 | 010425NXT | £219.95 |
| Sided | MTS5 | 360 | 125 | 1660 x 1000 x 530 | 010430NXT | £248.91 |
| Double | MTD4 | 480 | 250 | 1160 x 1000 x 750 | 010455NXT | £268.16 |
| Sided | MTD5 | 720 | 250 | 1660 x 1000 x 750 | 010460NXT | £310.35 |

(Note: NL= number of louvres, please refer to page 9)



011508A

Topstore - Single Sided Louvred Panel Trolley TC Bin Kits

| Containers Included | Order Ref | Containers Included | Order Ref | Containers Included | Order Ref | Price (Each) |
|------------------------------|-----------|---------------------|-----------|---------------------|-----------|--------------|
| 40 x TC2 Red & 40 x TC2 Blue | 011504A | 80 x TC2 Red | 011504B | 80 x TC2 Blue | 011504C | £279.00 |
| 18 x TC3 Red & 18 x TC3 Blue | 011506A | 36 x TC3 Red | 011506B | 36 x TC3 Blue | 011506C | £289.80 |
| 12 x TC4 Red & 12 x TC4 Blue | 011508A | 24 x TC4 Red | 011508B | 24 x TC4 Blue | 011508C | £298.40 |
| 8 x TC5 Red & 12 x TC5 Blue | 011510A | 20 x TC5 Red | 011510B | 20 x TC5 Blue | 011510C | £304.20 |
| 6 x TC6 Blue & 4 x TC6 Red | 011512A | 10 x TC6 Red | 011512B | 10 x TC6 Blue | 011512C | £289.60 |

Dimensions for above models: (MTS4) (H) 1160 x (W) 1000 x (D) 530mm

Topstore - Double Sided Louvred Panel Trolley TC Bin Kits

| Containers Included | Order Ref | Containers Included | Order Ref | Containers Included | Order Ref | Price (Each) |
|------------------------------|-----------|---------------------|-----------|---------------------|-----------|--------------|
| 80 x TC2 Red & 80 x TC2 Blue | 011505A | 160 x TC2 Red | 011505B | 160 x TC2 Blue | 011505C | £374.20 |
| 36 x TC3 Red & 36 x TC3 Blue | 011507A | 72 x TC3 Red | 011507B | 72 x TC3 Blue | 011507C | £409.60 |
| 24 x TC4 Red & 24 x TC4 Blue | 011509A | 48 x TC4 Red | 011509B | 48 x TC4 Blue | 011509C | £418.40 |
| 16 x TC5 Red & 24 x TC5 Blue | 011511A | 40 x TC5 Red | 011511B | 40 x TC5 Blue | 011511C | £419.60 |
| 12 x TC6 Blue & 8 x TC6 Red | 011513A | 20 x TC6 Red | 011513B | 20 x TC6 Blue | 011513C | £398.40 |

Dimensions for above models: (MTD4) (H) 1160 x (W) 1000 x (D) 750mm

N.B. Prices include 1 - I.D. label per bin



011513A



011510A



011505A

Topstore - Louvred Panel Trolley NXT-Gen Bin Kits

Topstore - Single Sided Louvred Panel Trolley NXT-Gen Bin Kits

| Product Description | Order Ref | H x W x D (mm) | Containers Included | Price (Each) |
|---------------------------|-----------|-------------------|--------------------------------|--------------|
| MTS4 Single Sided Trolley | 011501NXT | 1160 x 1000 x 530 | 36 x NXT1 Red & 45 x NXT2 Blue | £299.24 |
| MTS4 Single Sided Trolley | 011502NXT | 1160 x 1000 x 530 | 36 x NXT2 Red & 45 x NXT2 Blue | £320.97 |
| MTS4 Single Sided Trolley | 011503NXT | 1160 x 1000 x 530 | 36 x NXT2 Red & 20 x NXT3 Blue | £312.05 |
| MTS4 Single Sided Trolley | 011504NXT | 1160 x 1000 x 530 | 15 x NXT3 Red & 15 x NXT3 Blue | £290.58 |

Topstore - Double Sided Louvred Panel Trolley NXT-Gen Bin Kits

| Product Description | Order Ref | H x W x D (mm) | Containers Included | Price (Each) |
|---------------------------|-----------|-------------------|--------------------------------|--------------|
| MTD4 Double Sided Trolley | 011511NXT | 1160 x 1000 x 750 | 72 x NXT1 Red & 90 x NXT2 Blue | £428.46 |
| MTD4 Double Sided Trolley | 011512NXT | 1160 x 1000 x 750 | 72 x NXT2 Red & 90 x NXT2 Blue | £471.93 |
| MTD4 Double Sided Trolley | 011513NXT | 1160 x 1000 x 750 | 72 x NXT2 Red & 40 x NXT3 Blue | £454.08 |
| MTD4 Double Sided Trolley | 011514NXT | 1160 x 1000 x 750 | 30 x NXT3 Red & 30 x NXT3 Blue | £411.14 |

N.B. Prices include 1 - I.D. label per bin



011501NXT



011502NXT



011503NXT



011504NXT

Topstore - Bench Top Carousel

Fitted with a 500 (H) x 500mm (W) blue epoxy powder coated panel. This carousel is suitable for smaller NXT-GEN and TC containers and the unit rotates fully to allow complete access to all bins.

| Description | Order Ref | Price (Each) |
|-----------------------------------|-----------|--------------|
| Carousel (excludes containers) | 017015 | £153.78 |
| Kit c/w 40 x NXT2 Red Containers | 017015K | £186.62 |
| Kit c/w 40 x NXT2 Blue Containers | 017016K | £186.62 |
| Kit c/w 40 x TC2 Red Containers | 017020K | £180.08 |
| Kit c/w 40 x TC2 Blue Containers | 017025K | £180.08 |



017015K

017025K

N.B. Prices include 1 - I.D. label per bin

Topstore - Bench Stands

Epoxy powder coated blue panel and silver/grey side supports, these bench stands are suitable for use with the smaller range of NXT-GEN and TC containers and are available in 500(H) x 500mm(W) and 500(H) x 1000mm(W).



010186NXT

010187NXT

| Model | 1 | 2 | 3 | 4 | 5 | 6 | 7 | 8 |
|---------------------|-----------|------------|--------------|-------------|------------|---|-------------|---------------------------|
| H x W (mm) | 500 x 500 | 500 x 1000 | 500 x 500 | 500 x 500 | 500 x 500 | 500 x 1000 | 500 x 500 | 500 x 1000 |
| No. of Louvres | 60 | 120 | 60 | 60 | 60 | 120 | 60 | 120 |
| Containers Included | None | None | 20 Blue NXT2 | 20 Red NXT2 | 20 Red TC2 | 9 Red NXT1 27 Red NXT2 5 Red NXT3 | 20 Blue TC2 | 20 Red TC2 12 Blue TC3 |
| Order Ref | 010184NXT | 010185NXT | 010186NXT | 010186NXT/R | 010186TC | 010187NXT | 010187TC | 010188TC |
| Price (Each) | £40.88 | £51.24 | £55.96 | £55.96 | £54.04 | £85.56 | £54.04 | £83.08 |

N.B. Prices include 1 - I.D. label per bin

Topstore - Mesh Baskets

Topstore Mesh Baskets fit onto both metric and imperial panels, available in two sizes and are white plastic coated. Mesh front to back dividers are also available.

| Small Basket | | | |
|--------------|--------------------|--------------|--------------|
| Order Ref | H x W x D (mm) | Louvre Value | Price (Each) |
| 012593 | 200 x 460 x 200 | 30 | £41.89 |
| 012597 | Front/Back Divider | N/A | £14.47 |

| Large Basket | | | |
|--------------|--------------------|--------------|--------------|
| Order Ref | H x W x D (mm) | Louvre Value | Price (Each) |
| 012594 | 200 x 460 x 330 | 30 | £47.23 |
| 012598 | Front/Back Divider | N/A | £16.47 |



012593 & 012597

012594 & 012598

Topstore - Louvred Panel Spigots

Designed to fit onto Topstore Louvred Panels our range of Topstore Spigots are ideal for storing items such as coils that will not store easily on a shelf.

Available in 19mm square and 13mm round tube with a durable ABS plastic back plate for heavier applications.

Wire spigots are available in single and double options, manufactured from 3.6mm wire, the single spigots come complete with a rubber end cap for safety.

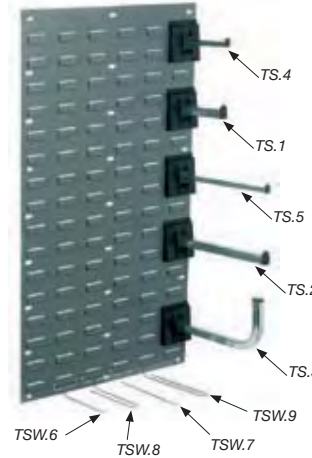

| Description | Order Ref | Price (per 10) |
|--|-----------|----------------|
| Louvre Value = 2 Load Capacity = 10kgs | | |
| TS.1 19mm Sq Tube x 152mm Long | 011031 | £49.25 |
| TS.2 19mm Sq Tube x 304mm Long | 011032 | £66.30 |
| TS.3 19mm Sq Tube x 304mm Long x 108mm upstand | 011033 | £79.85 |
| TS.4 13mm Diameter Round Tube x 152mm Long | 011034 | £48.51 |
| TS.5 13mm Diameter Round Tube x 304mm Long | 011035 | £58.24 |
| Louvre Value = 1 Load Capacity = 1kg | | |
| TSW.6 Single Wire x 152mm Long | 011036 | £15.44 |
| TSW.7 Single Wire x 203mm Long | 011037 | £16.45 |
| TSW.8 Double Wire x 152mm Long | 011038 | £17.34 |
| TSW.9 Double Wire x 203mm Long | 011039 | £21.30 |

Topstore - Fully Boxed Bin Kits

Pre-kitted Topstore Containers and Louvred Panels. Virtually any combination can be made to order.



| Boxed Kit Contents | Order Ref | Pack Quantity | Price (Per Pack) |
|--|-------------|---------------|------------------|
| 1 x 300 (H) x 320mm (W) Red Wall Mounted L/Panel c/w 6 x TC1 & 6 x TC2 Blue Bins | 010094RL/10 | 10 | £143.14 |
| 1 x 300 (H) x 320mm (W) Blue Wall Mounted L/Panel c/w 6 x TC1 & 6 x TC2 Red Bins | 010094BL/10 | 10 | £143.14 |
| 1 x 300 (H) x 457mm (W) Red Wall Mounted L/Panel c/w 6 x TC3 Blue Bins | 010095RL/5 | 5 | £103.95 |
| 1 x 300 (H) x 457mm (W) Blue Wall Mounted L/Panel c/w 6 x TC3 Red Bins | 010095BL/5 | 5 | £103.95 |
| Grey TP1 Panel c/w 8 x TC2 Red Bins & 8 x TC2 Blue Bins | 010171/5 | 5 | £132.99 |
| Grey TP1 Panel c/w 16 x TC2 Red Bins | 010171/R/5 | 5 | £132.99 |
| Grey TP2 Panel c/w 9 x TC3 Red & 9 x TC3 Blue Bins | 010172/5 | 5 | £289.55 |
| Grey TP10 Panel c/w 24 x TC2 Red Bins | 010174/5 | 5 | £158.26 |

N.B. Prices include 1 - I.D. label per bin

Excludes wall fixings

Topstore - Shelf Bins

Available in 17 sizes, these tough, blue polypropylene bins offer a practical alternative solution to cardboard or steel (other colours are available - please contact our sales department for details).

Shelf bins are impervious to most oils, greases and chemicals and make the best use of available shelf space - particularly when used with shelving systems.

The bin design includes a semi-open front, a facility for transparent dividers and a bin stop. For identification, durable plastic label holders (complete with labels) are available.

When not in use the bins will nest, reducing the amount of storage space required.

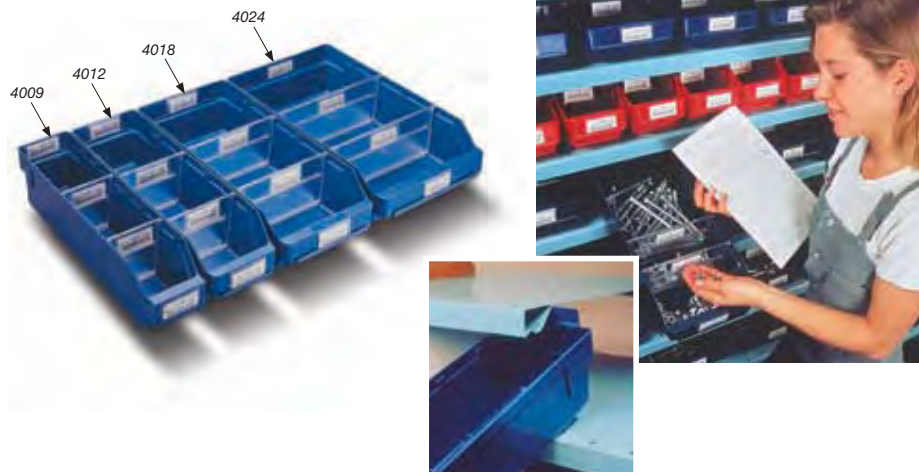

Bin Stop

| Type | L x W x H (mm) | Max Dividers per Bin | Pack Size | Order Ref | Price (Per Pack) |
|-------------------------|-----------------|----------------------|-----------|-----------|------------------|
| 3009 Bin | 300 x 90 x 95 | 5 | 40 | 066501 | £115.95 |
| 3012 Bin | 300 x 120 x 95 | 3 | 30 | 066502 | £96.85 |
| 3018 Bin | 300 x 180 x 95 | 3 | 20 | 066503 | £84.46 |
| 3024 Bin | 300 x 240 x 95 | 3 | 15 | 066504 | £68.49 |
| 4009 Bin | 400 x 90 x 95 | 7 | 40 | 066505 | £147.58 |
| 4012 Bin | 400 x 120 x 95 | 4 | 30 | 066506 | £129.86 |
| 4018 Bin | 400 x 180 x 95 | 4 | 20 | 066507 | £100.14 |
| 4024 Bin | 400 x 240 x 95 | 3 | 15 | 066508 | £89.04 |
| 4024-15 Bin | 400 x 240 x 150 | 3 | 10 | 066509 | £86.97 |
| 5009 Bin | 500 x 90 x 95 | 9 | 40 | 066510 | £179.20 |
| 5012 Bin | 500 x 120 x 95 | 6 | 30 | 066511 | £152.59 |
| 5018 Bin | 500 x 180 x 95 | 6 | 20 | 066512 | £117.27 |
| 5024 Bin | 500 x 240 x 95 | 3 | 15 | 066514 | £110.68 |
| 5024-15 Bin | 500 x 240 x 150 | 3 | 10 | 066515 | £102.78 |
| 6012 Bin | 600 x 120 x 95 | 7 | 30 | 066516 | £211.61 |
| 6024 Bin | 600 x 240 x 95 | 7 | 15 | 066517 | £120.57 |
| 6024-15 Bin | 600 x 240 x 150 | 4 | 10 | 066518 | £120.57 |
| Bin Stop | 80 x 40 | N/A | 100 | 066520 | £65.68 |
| P09 Divider | 90 x 95 | N/A | 50 | 066525 | £19.77 |
| P12 Divider | 120 x 95 | N/A | 50 | 066526 | £21.74 |
| P18 Divider | 180 x 95 | N/A | 25 | 066527 | £19.11 |
| P24 Divider | 240 x 95 | N/A | 25 | 066529 | £22.89 |
| P24-15 Divider | 240 x 150 | N/A | 10 | 066530 | £14.71 |
| Label Holder inc. label | 75 x 30 | N/A | 100 | 066536 | £22.14 |

Bins are not supplied with dividers/labels or bin stops, please order separately.

Topstore - Economy Shelf Bins

Specifically designed for parts retrieval and shelving systems. (Other colours are available - please contact our sales department for details).

- Multi-purpose shelf bins, available in 6 sizes.
- Highly durable moulded polypropylene resistant to most chemicals including acids and oils.
- Dividers and labels available, dividers snap securely into place.
- Colour: mottled grey.

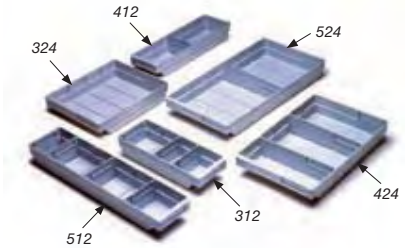

| Type | L x W x H (mm) | Max Dividers per Bin | Pack Size | Order Ref | Price (per pack) |
|------------|----------------|----------------------|-----------|-----------|------------------|
| 312 BIN | 300 x 120 x 65 | 3 | 36 | 066650 | £85.84 |
| 324 BIN | 300 x 240 x 65 | 3 | 18 | 066651 | £63.70 |
| 412 BIN | 400 x 120 x 65 | 4 | 36 | 066652 | £110.80 |
| 424 BIN | 400 x 240 x 65 | 4 | 18 | 066653 | £83.46 |
| 512 BIN | 500 x 120 x 65 | 5 | 36 | 066654 | £153.04 |
| 524 BIN | 500 x 240 x 65 | 5 | 18 | 066655 | £94.31 |
| 12 Divider | 120 x 65 | N/A | 50 | 066656 | £22.75 |
| 24 Divider | 240 x 65 | N/A | 50 | 066657 | £29.96 |
| Label | 22 x 75 | N/A | 100 | 066658 | £4.08 |

Bins are not supplied with dividers/labels, please order separately.

Topstore - Shelf Bin Cabinets

Designed for real space saving storage, this unit is modular and can be tailored around your specific needs to create a fully flexible system. Ideal for bench top use, stacked to produce a freestanding unit or even incorporated into shelving.

- Steel sheet construction with blue epoxy powder coated finish.
- Supplied complete with 5 fixed shelf levels, designed to accommodate Topstore Economy shelf bins featured above.
- Cabinets supplied fully assembled.
- Facility to store 6 x 120mm wide bins, or 3 x 240mm wide bins per shelf level or a combination of both.
- Equipped with location points for secure stacking.
- A maximum of three cabinets can be safely stacked.

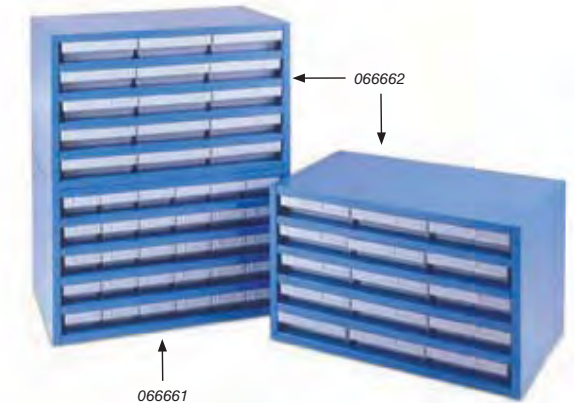

| Description | H x W x D (mm) | Order Ref | Price (Each) |
|--|-----------------|-----------|--------------|
| Cabinet Only | 475 x 810 x 500 | 066660 | £241.93 |
| Cabinet complete with 30 x 512 Bins | 475 x 810 x 500 | 066661 | £369.46 |
| Cabinet complete with 15 x 524 Bins | 475 x 810 x 500 | 066662 | £320.52 |
| Cabinet complete with 12 x 512 Bins & 9 x 524 Bins | 475 x 810 x 500 | 066663 | £340.10 |

Topstore - Container Cabinets

Topstore Container Cabinets come fully assembled and their robust all-steel construction offers flexible and secure storage for the office, workshop or stockroom.

Available in 3 sizes, epoxy powder coated silver/grey carcass and blue doors. Shelves are galvanised and adjustable at 50mm centres. All cabinets suit NXT-GEN and TC Containers, Shelf Bins and Eco Shelf Bins.

A fully recessed handle comes complete with 2 keys.

All shelves have a maximum load of 25kgs (Uniformly Distributed Load).

Dimensions:

Model 1: (H)1580 x (W)770 x (D)330mm

Model 2: (H)1000 x (W)1015 x (D)430mm

Model 3: (H)2000 x (W)1015 x (D)430mm

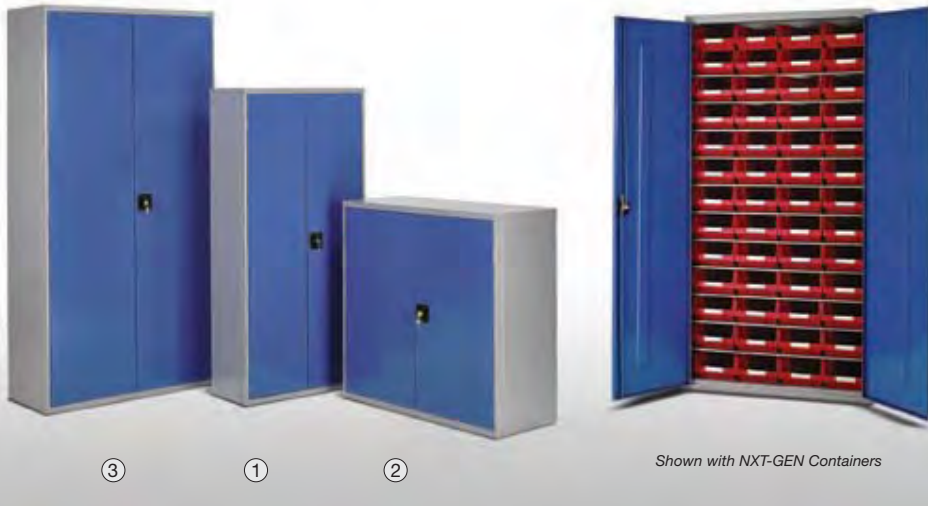

Model 1: (H) 1580 x (W) 770 x (D) 330mm

| Description | Order Ref | Shelves | Price (Each) |
|---|-----------|---------|--------------|
| Cabinet | 013000 | 0 | £307.97 |
| Cabinet c/w shelves | 013005 | 6 | £386.43 |
| Pack of 3 shelves - 770 (W) x 330mm (D) | 013004 | 3 | £39.36 |
| Cabinet c/w 40 x NXT3 Blue Containers | 013008NXT | 9 | £483.72 |
| Cabinet c/w 40 x NXT3 Red Containers | 013009NXT | 9 | £483.72 |
| Cabinet c/w 40 x NXT3 White Containers | 013010NXT | 9 | £480.81 |
| Cabinet c/w 40 x TC3 Blue Containers | 013008 | 9 | £472.41 |
| Cabinet c/w 40 x TC3 Red Containers | 013009 | 9 | £472.41 |
| Cabinet c/w 40 x TC3 White Containers | 013010 | 9 | £470.07 |
| Cabinet c/w 40 x TC3 Blue Containers | 013011 | 4 | £407.02 |
| Cabinet c/w 40 x TC3 Red Containers | 013012 | 4 | £407.02 |
| Cabinet c/w 40 x TC3 White Containers | 013013 | 4 | £404.68 |

N.B. Prices include 1 - I.D. label per bin

Topstore - Container Cabinets

Model 2: (H) 1000 x (W) 1015 x (D) 430mm

| Description | Order Ref | Shelves | Price (Each) |
|---|-----------|---------|--------------|
| Cabinet | 013020 | 0 | £293.83 |
| Cabinet c/w shelves | 013024 | 3 | £348.26 |
| Pack of 3 shelves - 1015 (W) x 430mm (D) | 013023 | 3 | £50.38 |
| Cabinet c/w 24 x NXT4 Red Containers | 013025NXT | 5 | £442.29 |
| Cabinet c/w 24 x NXT4 Blue Containers | 013026NXT | 5 | £442.29 |
| Cabinet c/w 24 x NXT4 White Containers | 013027NXT | 5 | £439.37 |
| Cabinet c/w 24 x TC4 Red Containers | 013025 | 5 | £431.28 |
| Cabinet c/w 24 x TC4 Blue Containers | 013026 | 5 | £431.28 |
| Cabinet c/w 24 x TC4 White Containers | 013027 | 5 | £428.93 |
| Cabinet c/w 24 x TC4 Red Containers | 013028 | 2 | £376.86 |
| Cabinet c/w 24 x TC4 Blue Containers | 013029 | 2 | £376.86 |
| Cabinet c/w 16 x TC5 Blue Containers | 013031 | 2 | £377.61 |
| Cabinet c/w 16 x TC5 Red Containers | 013032 | 2 | £377.61 |
| Cabinet c/w 16 x TC5 Blue Containers | 013034 | 3 | £395.75 |
| Cabinet c/w 16 x TC5 Red Containers | 013035 | 3 | £395.75 |
| Cabinet c/w 8 x TC6 Red Containers | 013037 | 3 | £388.97 |
| Cabinet c/w 8 x TC6 Blue Containers | 013038 | 3 | £388.97 |
| Cabinet c/w 8 x TC6 Red Containers | 013040 | 2 | £370.83 |
| Cabinet c/w 8 x TC6 Blue Containers | 013041 | 2 | £370.83 |
| Cabinet c/w 4 x TC6 Red & 8 x TC5 Blue Containers | 013043 | 2 | £374.22 |

N.B. Prices include 1 - I.D. label per bin



Model 3: (H) 2000 x (W) 1015 x (D) 430mm

| Description | Order Ref | Shelves | Price (Each) |
|---|-----------|---------|--------------|
| Cabinet | 013050 | 0 | £385.32 |
| Cabinet c/w shelves | 013051 | 6 | £494.17 |
| Pack of 3 shelves - 1015 (W) x 430mm (D) | 013023 | 3 | £50.38 |
| Cabinet c/w 52 x NXT4 Red Containers | 013055NXT | 11 | £710.00 |
| Cabinet c/w 52 x NXT4 Blue Containers | 013056NXT | 11 | £710.00 |
| Cabinet c/w 52 x NXT4 White Containers | 013057NXT | 11 | £703.68 |
| Cabinet c/w 4 x TC6 Red, 28 x TC5 Blue & 4 x TC4 Red Containers | 013052 | 8 | £641.72 |
| Cabinet c/w 20 x TC5 Blue & 24 x TC4 Red Containers | 013053 | 10 | £672.85 |
| Cabinet c/w 52 x TC4 Red Containers | 013055 | 11 | £686.15 |
| Cabinet c/w 52 x TC4 Blue Containers | 013056 | 11 | £686.15 |
| Cabinet c/w 52 x TC4 White Containers | 013057 | 11 | £681.05 |
| Cabinet c/w 52 x TC4 Red Containers | 013058 | 6 | £595.44 |
| Cabinet c/w 52 x TC4 Blue Containers | 013059 | 6 | £595.44 |
| Cabinet c/w 52 x TC4 White Containers | 013060 | 6 | £590.34 |

N.B. Prices include 1 - I.D. label per bin

Topdrawer - Small Parts Cabinets and Trolley

A selection of free-standing units and trolley ideal for most environments, that can be floor mounted for added security (floor fixings not included). The range provides medium to high volume storage for small parts. All cabinets are pre-galvanised and powder coated in grey.

The drawers are manufactured from ABS/Styrene and include both inner dividers for greater flexibility and I.D labels. They are fitted with clear front windows for easier visibility of stored items. Drawers are also oil corrosion resistant and have high impact strength. All of the drawers can be completely removed.

Additional dividers and index labels can be ordered separately.



Topdrawer - Trolley c/w 30 Drawers

The fixed chrome handle and 100mm Ø swivel castors (2 are braked) provide easy transportation of stored goods. The galvanised shelves prevent damage from acid, oxidation and abrasion and can hold up to 50 kg per level.

The trolley drawers are designed with an anti-drop device when drawer has been fully pulled out.

- Rubber castors 2 braked and 2 swivel - 100mm
- 7 divider locations in each drawer



052001

| Description | H x W x D (mm) | Trolley Capacity (Kg) | Drawer Size H x W x D (mm) | Drawer Capacity (Kg) | No. of Dividers Provided | Order Ref | Price (Each) |
|----------------------------|-----------------|-----------------------|----------------------------|----------------------|--------------------------|------------|--------------|
| 30 Drawer Trolley | 880 x 880 x 400 | 300 | 105 x 164 x 375 | 10 | 60 | 052001 | £505.00 |
| Dividers (Pack of 60) | - | - | - | - | - | 052008/60 | £35.00 |
| Index Labels (Pack of 100) | 126 x 21 | - | - | - | - | 052021/100 | £11.00 |

Topdrawer - Cabinets c/w 12/24 Drawers

A range of cabinets designed to be mounted on either a bench, counter or table top, or if required can be wall fitted (wall fixings are not included).

- 5 divider locations in each drawer for both cabinets

| Description | H x W x D (mm) | Cabinet Capacity (Kg) | Drawer Size H x W x D (mm) | Drawer Capacity (Kg) | No. of Dividers Provided | Order Ref | Price (Each) |
|----------------------------|-----------------|-----------------------|----------------------------|----------------------|--------------------------|------------|--------------|
| 12 Drawer Cabinet | 350 x 586 x 290 | 72 | 69 x 163 x 289 | 6 | 12 | 052002 | £125.00 |
| 24 Drawer Cabinet | 640 x 586 x 290 | 144 | 69 x 163 x 289 | 6 | 24 | 052003 | £195.00 |
| Dividers (Pack of 100) | - | - | - | - | - | 052009/100 | £37.50 |
| Index Labels (Pack of 100) | 76 x 14 | - | - | - | - | 052020/100 | £4.50 |



052002



052003

Topdrawer - Cabinets with/without Doors c/w 48 Drawers

A large free standing floor cabinet complete with 48 drawers ideal for storing a higher volume of small parts.

- 3 divider locations in each drawer
- 3 point locking mechanism on cabinet and supplied with 2 keys (052005)

| Description | H x W x D (mm) | Cabinet Capacity (Kg) | Drawer Size H x W x D (mm) | Drawer Capacity (Kg) | No. of Dividers Provided | Order Ref | Price (Each) |
|---------------------------------|-----------------|-----------------------|----------------------------|----------------------|--------------------------|------------|--------------|
| 48 Drawer Cabinet without Doors | 937 x 586 x 222 | 240 | 69 x 120 x 218 | 5 | 48 | 052004 | £265.00 |
| 48 Drawer Cabinet with Doors | 970 x 586 x 270 | 240 | 69 x 120 x 218 | 5 | 48 | 052005 | £405.00 |
| Dividers (Pack of 200) | - | - | - | - | - | 052010/200 | £40.00 |
| Index Labels (Pack of 100) | 76 x 14 | - | - | - | - | 052020/100 | £4.50 |



052004



052005

Topdrawer - Cabinets c/w 60/75 Drawers

A range of cabinets complete with 60 or 75 transparent drawers which are designed for easier product selection while utilising full use of natural light.

- 3 divider locations in each drawer

| Description | H x W x D (mm) | Cabinet Capacity (Kg) | Drawer Size H x W x D (mm) | Drawer Capacity (Kg) | No. of Dividers Provided | Order Ref | Price (Each) |
|--|-----------------|-----------------------|----------------------------|----------------------|--------------------------|------------|--------------|
| 60 Drawer Cabinet | 937 x 586 x 222 | 228 | 55 x 120 x 218 | 3.8 | 60 | 052007 | £275.00 |
| 75 Drawer Cabinet | 937 x 586 x 222 | 247.5 | 55 x 90 x 218 | 3.3 | 75 | 052006 | £310.00 |
| Dividers for 60 Drawer Cabinet (Pack of 200) | - | - | - | - | - | 052012/200 | £40.00 |
| Dividers for 75 Drawer Cabinet (Pack of 250) | - | - | - | - | - | 052011/250 | £35.00 |
| Index Labels (Pack of 100) | 76 x 14 | - | - | - | - | 052020/100 | £4.50 |



052007



052006

Topstore - Clearbox

The ideal dust-free storage and display system for the warehouse, workshop, retail and trade. Each unit contains a number of removable transparent inner compartments suitable for a wide range of items with a beige outer body.

To provide the ultimate in flexibility of application, Clearbox can be fixed directly to the wall, fitted to freestanding metal racks (single or double sided) or which can be converted to provide a mobile unit.

Whatever the format, Clearbox provides the answer.

- Flexible – suitable for a variety of uses and applications
- Non-toxic – suitable for use with food stuffs
- Strong – outer body manufactured from high-impact polystyrene plastic and inner compartments from ABS plastic
- Order picking – tilting transparent compartments allow easy retrieval of items with maximum display potential
- A retaining bar is available (for all Clearbox sizes) to secure individual compartments in place and prevent accidental displacement when in transit. Finished zinc plated.

All units have a common width of 600mm and are available in 6 sizes, each providing a different number of compartments suitable for a range of small components.

| Clearbox Units | | | |
|----------------|-----------------|-----------|--------------|
| Ref | H x W x D (mm) | Order Ref | Price (Each) |
| No. 9 | 77 x 600 x 64 | 051380 | £10.45 |
| No. 6 | 113 x 600 x 93 | 051381 | £14.12 |
| No. 5 | 164 x 600 x 135 | 051382 | £21.16 |
| No. 4 | 207 x 600 x 171 | 051383 | £30.34 |
| No. 3 | 240 x 600 x 197 | 051384 | £37.72 |
| No. 2 | 353 x 600 x 310 | 051385 | £82.68 |
| Retaining bar | | 051090 | £1.90 |

| Clearbox Units (BULK) | | | |
|-----------------------|---------------|-----------|------------------|
| Ref | Pack Quantity | Order Ref | Price (per pack) |
| No. 9 | 10 | 051380/10 | £89.60 |
| No. 6 | 10 | 051381/10 | £121.05 |
| No. 5 | 10 | 051382/10 | £181.39 |
| No. 4 | 10 | 051383/10 | £247.94 |
| No. 3 | 5 | 051384/5 | £161.64 |
| No. 2 | 5 | 051385/5 | £354.36 |

NOTE:

A: To calculate the quantity of Clearbox units that can be accommodated on any one of the applications, divide the height of the unit into the storage space of the application.

B: To enable Clearbox units to be fitted onto other applications marked *, please order 2 Fixing brackets (Ref 051169) per unit, price included.

| Description | Dimensions H x W x D (mm) | Clearbox Storage Space | Order Ref | Price (Each) |
|---------------------------|---------------------------|------------------------|-----------|--------------|
| *Single sided floor stand | 1880 x 600 x 440 | 1850mm | 051130 | £125.20 |
| *Double sided floor stand | 1880 x 600 x 610 | 1850mm | 051140 | £142.54 |
| *Wall Frame Only | 635 (H) x 600 (W) | 630mm | 051241 | £39.55 |
| *Double sided Trolley | 1350 x 600 x 600 | 1190mm | 051100 | £200.09 |
| Fixing Bracket | 2 required per unit | - | 051169 | N/A |

| Clearbox Combinations - Complete with Clearbox Units | | | | | | | | | | |
|--|------------------|-------|-------|-------|-------|-------|-------|-----------|---------|--|
| Description | H x W x D (mm) | No. 9 | No. 6 | No. 5 | No. 4 | No. 3 | No. 2 | Order Ref | £/Set | |
| Single Sided Floor Stand | 1880 x 600 x 440 | 4 | 3 | 1 | 1 | 2 | 1 | 051130K | £447.39 | |
| Single Sided Floor Stand | 1880 x 600 x 440 | - | - | - | 9 | - | - | 051131 | £421.58 | |
| Double Sided Floor Stand | 1880 x 600 x 610 | 8 | 6 | 2 | 2 | 4 | 2 | 051140K | £752.24 | |
| Double Sided Floor Stand | 1880 x 600 x 610 | - | - | - | 18 | - | - | 051141 | £700.62 | |
| Double Sided Trolley | 1420 x 600 x 610 | - | 4 | 2 | 2 | 2 | 2 | 051100K | £564.12 | |
| Double Sided Trolley | 1420 x 600 x 610 | - | - | - | - | 10 | - | 051142 | £541.73 | |
| Wall Mounted Unit | 635 x 600 x 175 | 2 | 1 | 2 | - | - | - | 051275 | £122.09 | |

Labels Supplied



Labels Supplied / Excludes wall fixings

Topstore - Visibins

Visibins represent a new concept in flexible modular storage and display of small parts, manufactured in blue polypropylene. Visibin Containers are available with or without a hinged clip-shut clear styrene lids. They provide a lightweight method of displaying and storing a variety of small parts in a dust-free environment.

To complete the range, the VB6 is a one litre segmented container with 12 compartments available to take care of those very small items. Visibins are designed to lock onto their own zinc-plated wire mesh grid system creating a strong, lightweight unit with maximum product visibility.

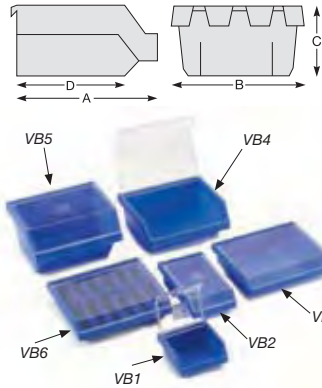

| Visibin | VB 1 | VB 2 | VB 3 | VB 4 | VB 5 | VB 6 |
|----------------------------------|--------------|--------------|--------------|--------------|--------------|--------------|
| Size mm | | | | | | |
| Overall Length A | 91 | 153 | 153 | 153 | 153 | 153 |
| Overall Width B | 99 | 99 | 200 | 200 | 200 | 200 |
| Overall Height C | 47 | 47 | 47 | 79 | 113 | 47 |
| Base Length D | 69 | 130 | 130 | 120 | 110 | 130 |
| Volume (Litre) | 0.25 | 0.5 | 1.00 | 1.50 | 2.00 | 1.00 |
| Grid Value | 6 | 6 | 12 | 18 | 24 | 12 |
| No. Containers per Carton | 18 | 18 | 8 | 6 | 4 | 8 |
| Blue Order Ref | 012311 | 012321 | 012331 | 012341 | 012351 | 012361 |
| Price per Carton | £18.09 | £31.15 | £16.66 | £15.12 | £10.64 | £19.18 |
| Visibin Lids | VBL 1 | VBL 2 | VBL 3 | VBL 4 | VBL 5 | VBL 6 |
| No. of Lids per Carton | 18 | 18 | 8 | 6 | 4 | 8 |
| Clear Order Ref | 012310 | 012320 | 012330 | 012340 | 012350 | 012360 |
| Price per Carton | £19.67 | £21.07 | £13.65 | £11.27 | £8.47 | £13.65 |

Containers can be manufactured in own brand and colours for high volume users.

Topstore - Visibin Kits

| Product Included | Order Ref | Price (Each) |
|--|-----------|--------------|
| Visibins complete with Lids (18 x VB1 Bins & 18 x VBL1 Lids) | 012314 | £36.96 |
| Visibins complete with Lids (18 x VB2 Bins & 18 x VBL2 Lids) | 012324 | £52.22 |
| Visibins complete with Lids (8 x VB3 Bins & 8 x VBL3 Lids) | 012334 | £30.31 |
| Visibins complete with Lids (6 x VB4 Bins & 6 x VBL4 Lids) | 012344 | £26.39 |
| Visibins complete with Lids (4 x VB5 Bins & 4 x VBL5 Lids) | 012354 | £19.11 |
| Visibins complete with Lids (8 x VB6 Bins & 8 x VBL6 Lids) | 012364 | £32.83 |

Topstore - Visibin Bench Stand

The Visibin bench stand provides free standing, removable storage for any flat surface such as a work bench.

| Visibin Bench Stand | H x W x D (mm) | No. of Grids | Order Ref | Price (Each) |
|---------------------|-----------------|--------------|-----------|--------------|
| VBBS | 515 x 645 x 255 | 216 | 012376 | £61.22 |

Visibins not included (please order separately)



VBBS/5/L

Topstore - Visibin Bench Stand Kits

| Visibin Bench Stand WITH LIDS | | | Visibin Bench Stand WITHOUT LIDS | |
|--|-----------|--------------|----------------------------------|--------------|
| Product Included | Order Ref | Price (Each) | Order Ref | Price (Each) |
| Bench Stand c/w 36 x VB1 Bins & 36 VBL1 Lids | VBBSK/1/L | £101.44 | VBBSK/1/NL | £79.31 |
| Bench Stand c/w 36 x VB2 Bins & 36 VBL2 Lids | VBBSK/2/L | £131.96 | VBBSK/2/NL | £91.37 |
| Bench Stand c/w 15 x VB3 Bins & 15 VBL3 Lids | VBBSK/3/L | £87.38 | VBBSK/3/NL | £76.29 |
| Bench Stand c/w 12 x VB4 Bins & 12 VBL4 Lids | VBBSK/4/L | £84.40 | VBBSK/4/NL | £75.29 |
| Bench Stand c/w 9 x VB5 Bins & 9 VBL5 Lids | VBBSK/5/L | £80.44 | VBBSK/5/NL | £72.15 |
| Bench Stand c/w 15 x VB6 Bins & 15 VBL6 Lids | VBBSK/6/L | £89.12 | VBBSK/6/NL | £76.92 |

Topstore - Visibin Trolley

This trolley provides an ideal solution for storage of small parts and components. It provides easy mobility combined with aesthetics suitable for use in the warehouse or on the shop floor.

This trolley has 4 swivel castors (80mm diameter) and handle to provide easy mobility and has two mesh panels to hold the bins securely in place.

| Description | H x W x D (mm) | No. of Grids | Order Ref | Price (Each) |
|-------------|------------------|--------------|-----------|--------------|
| Trolley | 1500 x 655 x 610 | 1258 | 012415 | £187.08 |

Trolleys are supplied without bins, please order separately.



Topstore - Visibin Wall Grids

Visibin Wall Grids are available in two wall-mounted sizes which are easily fixed using the clips provided.

| Visibin Wall Grids | H x W (mm) | No. of Grids | Order Ref | Price (Each) |
|--------------------|------------|--------------|-----------|--------------|
| VBG1 c/w Fixings | 630 x 425 | 216 | 012371 | £40.51 |
| VBG2 c/w Fixings | 630 x 860 | 450 | 012372 | £59.43 |

Visibins not included (please order separately)



VBG1K/5/NL



VBG2K/1/L



VBG1K/3/NL

Topstore - Visibin Wall Grid Kits

| Visibin Wall Grid WITH LIDS | | | Visibin Wall Grid WITHOUT LIDS | |
|---|-----------|--------------|--------------------------------|--------------|
| Product Included | Order Ref | Price (Each) | Order Ref | Price (Each) |
| VBG1 Wall Grid c/w 36 x VB1 Bins & 36 x VBL1 Lids | VBG1K/1/L | £89.55 | VBG1K/1/NL | £58.61 |
| VBG1 Wall Grid c/w 36 x VB2 Bins & 36 x VBL2 Lids | VBG1K/2/L | £120.07 | VBG1K/2/NL | £77.93 |
| VBG1 Wall Grid c/w 18 x VB3 Bins & 18 x VBL3 Lids | VBG1K/3/L | £83.83 | VBG1K/3/NL | £58.61 |
| VBG1 Wall Grid c/w 12 x VB4 Bins & 12 x VBL4 Lids | VBG1K/4/L | £68.41 | VBG1K/4/NL | £54.59 |
| VBG1 Wall Grid c/w 8 x VB5 Bins & 8 x VBL5 Lids | VBG1K/5/L | £57.60 | VBG1K/5/NL | £50.23 |
| VBG1 Wall Grid c/w 18 x VB6 Bins & 18 x VBL6 Lids | VBG1K/6/L | £89.50 | VBG1K/6/NL | £59.36 |
| VBG2 Wall Grid c/w 72 x VB1 Bins & 72 x VBL1 Lids | VBG2K/1/L | £169.18 | VBG2K/1/NL | £95.62 |
| VBG2 Wall Grid c/w 72 x VB2 Bins & 72 x VBL2 Lids | VBG2K/2/L | £230.22 | VBG2K/2/NL | £145.94 |
| VBG2 Wall Grid c/w 24 x VB3 Bins & 24 x VBL3 Lids | VBG2K/3/L | £122.23 | VBG2K/3/NL | £95.62 |
| VBG2 Wall Grid c/w 24 x VB4 Bins & 24 x VBL4 Lids | VBG2K/4/L | £126.90 | VBG2K/4/NL | £87.58 |
| VBG2 Wall Grid c/w 16 x VB5 Bins & 16 x VBL5 Lids | VBG2K/5/L | £97.78 | VBG2K/5/NL | £78.87 |
| VBG2 Wall Grid c/w 24 x VB6 Bins & 24 x VBL6 Lids | VBG2K/6/L | £123.74 | VBG2K/6/NL | £97.13 |

Topstore - Space Bin Containers

Large polypropylene constructed container that can either be stacked or nested.

Supplied in packs of 5.

- Ideal for separating goods
- Product selection made easy when stacked
- Designed to save space
- Each container capacity: 50 litres
- Maximum load capacity: 15 kgs when stacked (max 4 high)
- Colour : Dark grey



| Product Description | External H x W x D (mm) | Internal H x W x D (mm) | Order Ref | Pack Qty | Price (Per Pack) | BULK | | | |
|----------------------|-------------------------|-------------------------|-----------|----------|------------------|-----------|-----------------------------|------------|--------------------|
| | | | | | | Order Ref | Pallet Size: W x D x H (mm) | Pallet Qty | Price (Per Pallet) |
| Space Bin Containers | 320 x 495 x 390 | 320 x 440 x 340 | E54SB/5 | 5 | £52.50 | E54SB/92 | 1200 x 800 x 2360 | 92 | £770.00 |

Topstore - Topbox

Ideal for storing all kinds of small parts for home, office, warehouse equipment. All Containers manufactured from Polypropylene.

- Containers are available with and without clip-on lids
- Transparent container makes product selection easier
- Stackable
- Nestable



| Product Description | Container Size: L x W x H (mm) | Order Ref | Pack Qty | Price (Per Pack) |
|--------------------------------|--------------------------------|---------------|----------|------------------|
| 24 Ltr Containers with Lids | 430 x 325 x 245 | 012450/10 | 10 | £65.40 |
| 24 Ltr Containers without Lids | 430 x 325 x 245 | 012450/WOL/10 | 10 | £49.70 |
| 35 Ltr Containers with Lids | 490 x 395 x 260 | 012455/10 | 10 | £87.19 |
| 35 Ltr Containers without Lids | 490 x 395 x 260 | 012455/WOL/10 | 10 | £68.90 |

| BULK | Pallet Size: W x D x H (mm) | Order Ref | No. of containers per Bulk Pallet | Price (Per Pallet) |
|-----------------------------|-----------------------------|------------|-----------------------------------|--------------------|
| 24 Ltr Containers with Lids | 1200 x 1000 x 1850 | 012450/300 | 300 | £1,478.70 |
| 35 Ltr Containers with Lids | 1200 x 1000 x 1750 | 012455/180 | 180 | £1,345.14 |

4 x 24Ltr Containers can be fitted to a trolley. Please refer to Container Trolleys (Ref DCT14X24L) on page 39.

Topstore - Multi-functional Containers

Multi-functional sorting storage bin with lids. Supplied in packs of 4 with various lid colour options available.

- Ideal for separating items
- Manufactured from polypropylene
- Removable hinged lids
- Stackable/Nestable
- Can be used as colour coded bins for recycling items and segregation
- Each container capacity: 50 litres
- Maximum load capacity: 30 kgs when stacked (max 5 high)
- Containers are stackable with or without lids

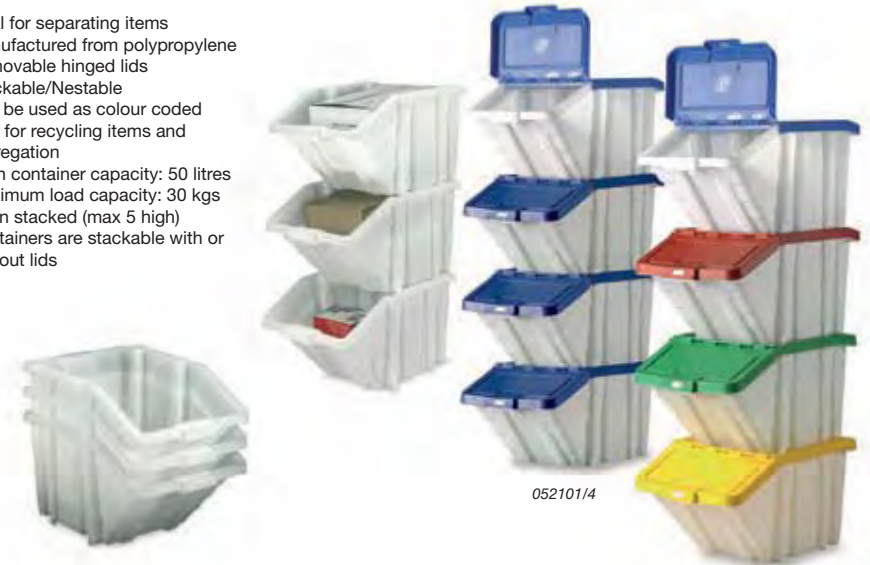

| Product Description | H x W x D (mm) | Order Ref | Pack Qty | Price (Per Pack) | BULK | | | |
|-----------------------------------|-----------------|-----------|----------|------------------|-----------|----------------------------|------------|--------------------|
| | | | | | Order Ref | Pallet Size W x D x H (mm) | Pallet Qty | Price (Per Pallet) |
| Containers with Mixed Colour Lids | 345 x 400 x 635 | 052100/4 | 4 | £82.50 | 052100/15 | 1130 x 1350 x 2030 | 15 | £955.00 |
| Containers with Blue Lids | 345 x 400 x 635 | 052101/4 | 4 | £82.50 | 052101/15 | 1130 x 1350 x 2030 | 15 | £955.00 |
| Containers with Red Lids | 345 x 400 x 635 | 052102/4 | 4 | £82.50 | 052102/15 | 1130 x 1350 x 2030 | 15 | £955.00 |
| Containers with Green Lids | 345 x 400 x 635 | 052104/4 | 4 | £82.50 | 052104/15 | 1130 x 1350 x 2030 | 15 | £955.00 |
| Containers with Yellow Lids | 345 x 400 x 635 | 052106/4 | 4 | £82.50 | 052106/15 | 1130 x 1350 x 2030 | 15 | £955.00 |

Total No. of Containers on pallet: 60

Topstore - Blue Plastic Dolly

A lightweight polypropylene container dolly fitted with 4 x black swivel 80mm dia. nylon castors. Ideal for easy transportation of bulky items.

- Injection moulded construction
- Colour : Blue
- Carrying handle for easy transportation when not in use.



| Product Description | H x W x D (mm) | Capacity (Kgs) | Order Ref | Price |
|---------------------|-----------------|----------------|-----------|--------|
| Blue Plastic Dolly | 600 x 400 x 110 | 100 | BPD | £27.10 |

Topstore - Euro Containers

Robust grey plastic containers that can interstack modularly with various sizes. Ideal for protective storage during transportation of goods. Dividers, lids and dollies can be supplied separately. All containers and accessories are manufactured from high-density polypropylene and have a temperature resistance from (-20°C to +40°C). A foldable container option is also available which saves storage space when not being used.

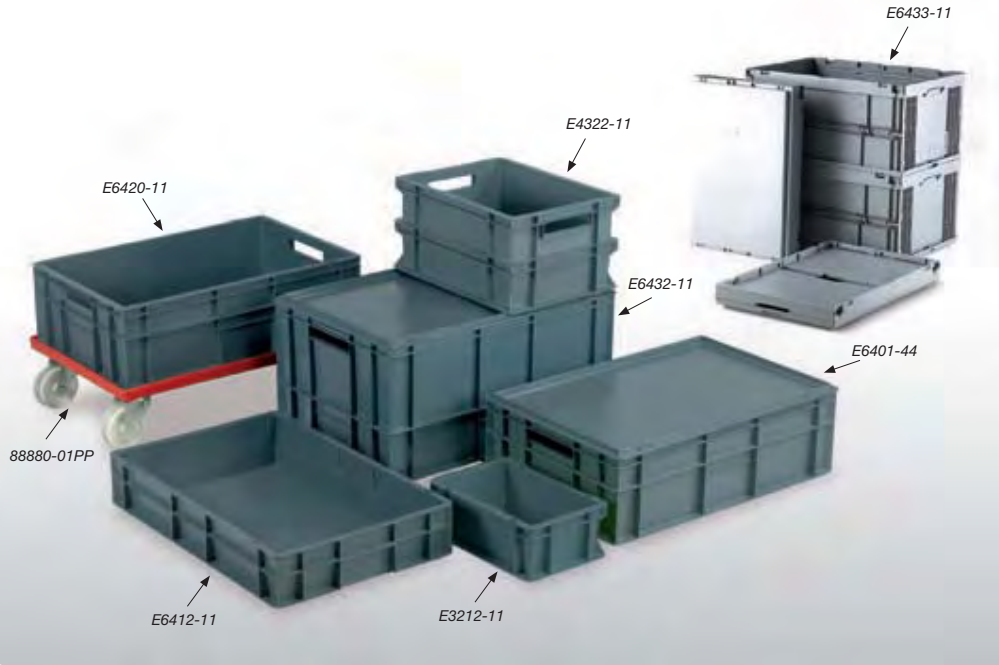

| Product Description | External L x W x H (mm) | Internal L x W x H (mm) | Order Ref | Price (Each) | BULK | | | |
|---------------------|-------------------------|-------------------------|-----------|--------------|--------------|--------------------|------------|------------------|
| | | | | | Order Ref | Pallet Height (mm) | Pallet Qty | Price Per Pallet |
| 5 ltr | 300 x 200 x 120 | 270 x 170 x 110 | E3212-11 | £5.50 | E3212-11/288 | 2120 | 288 | £1340.00 |
| 20 ltr | 400 x 300 x 220 | 365 x 265 x 207 | E4322-11 | £12.27 | E4322-11/104 | 2090 | 104 | £1,093.44 |
| 22 ltr | 600 x 400 x 120 | 555 x 355 x 112 | E6412-11 | £13.90 | E6412-11/72 | 2100 | 72 | £857.93 |
| 33 ltr | 600 x 400 x 170 | 555 x 355 x 158 | E6417-11 | £16.35 | E6417-11/52 | 2200 | 52 | £728.96 |
| 40 ltr | 600 x 400 x 200 | 555 x 355 x 187 | E6420-11 | £16.00 | E6420-11/44 | 2210 | 44 | £603.41 |
| 60 ltr | 600 x 400 x 320 | 555 x 355 x 307 | E6432-11 | £20.94 | E6432-11/36 | 2080 | 36 | £646.19 |
| 59 ltr Foldable | 594 x 396 x 314 | 558 x 362 x 294 | E6433-11 | £28.44 | - | - | - | - |

All Pallet Sizes - W x D (mm) - 1200 x 800

Euro Container Lids

Lids are available in packs of 10, in two sizes to suit both (400x300mm) and (600x400mm) containers. These are drop-on lids (not hinged).

| Product Description | Dimensions (mm) | Order Ref | Price (Pack) |
|---|-----------------|-------------|--------------|
| Euro Container Lid - Dark Grey <i>Lid can fit to the E4322-11 Euro Container ONLY</i> | 400 x 300 x 19 | E4301-45/10 | £62.20 |
| Euro Container Lid - Dark Grey <i>Lid can fit to the E6412-11, E6417-11, E6420-11 & E6432-11 Euro Containers</i> | 600 x 400 x 16 | E6401-44/10 | £78.20 |

Euro Container Dividers

- Dividers are suitable for L600 x W400 mm Euro Containers only, except E6412-11 Container
- Dividers supplied in packs of 10
- 6 dividers available, (3 x top handle, 3 x base dividers)

| Product Description | No. of Divisions | Size of each (Internal) Division (L x W) | Order Ref | Price (Pack) |
|---|------------------|--|------------|--------------|
| 15 Divider - Locates into Top Handles of Euro Container | 15 | 105 x 112 | E64TD15/10 | £84.51 |
| 15 Divider - Locates in Base of Euro Container | 15 | 105 x 112 | E64BD15/10 | £84.51 |
| 24 Divider - Locates into Top Handles of Euro Container | 24 | 82 x 86 | E64TD24/10 | £92.75 |
| 24 Divider - Locates in Base of Euro Container | 24 | 82 x 86 | E64BD24/10 | £92.75 |
| 40 Divider - Locates into Top Handles of Euro Container | 40 | 64 x 65 | E64TD40/10 | £96.46 |
| 40 Divider - Locates in Base of Euro Container | 40 | 64 x 65 | E64BD40/10 | £96.46 |



Euro Container Dollies

Two ABS plastic dolly options are available with or without a handle, both capable of carrying up to 100Kg, perfect to transport multiple containers without causing excessive strain. It is fitted with 4 x swivel white nylon castors (100mm dia.)

The steel handle, finished zinc and yellow passivated, can be adjusted in height and can be removed from dolly when not in use.



| Product Description | External L x W x H (mm) | Internal L x W x H (mm) | Handle L (mm) | Without Handle | | With Handle | |
|-----------------------|-------------------------|-------------------------|---------------|-----------------|--------------|-----------------|--------------|
| | | | | Order Ref | Price (Each) | Order Ref | Price (Each) |
| Dolly | 625 x 420 x 160 | 600 x 400 | 625 | 88880-01PP | £56.89 | 88880-01WH | £86.41 |
| Dolly c/w 9 x 6412-11 | 625 x 420 x 1230 | 600 x 400 | 625 | 88880-01PP/6412 | £170.00 | 88880-01WH/6412 | £195.00 |
| Dolly c/w 7 x 6417-11 | 625 x 420 x 1340 | 600 x 400 | 625 | 88880-01PP/6417 | £160.00 | 88880-01WH/6417 | £185.00 |
| Dolly c/w 5 x 6420-11 | 625 x 420 x 1150 | 600 x 400 | 625 | 88880-01PP/6420 | £135.00 | 88880-01WH/6420 | £165.00 |
| Dolly c/w 3 x 6432-11 | 625 x 420 x 1110 | 600 x 400 | 625 | 88880-01PP/6432 | £115.00 | 88880-01WH/6432 | £145.00 |

Topstore - Clearbox Flex-bins

Clearbox "Flex-Bins" like the original Clearbox bins tilt open at an angle, but are manufactured as one single long drawer, which with the aid of "click-in" dividers can be partitioned into various sized smaller compartments.

Each unit is supplied complete with 6 adjustable dividers to give a maximum of 7 separate storage locations, and another option with a maximum of 3 storage locations. This gives the user full control over the size and number of locations, allowing full flexibility for endless visible storage applications.

- A retaining bar is available for both options, to secure the single compartments in place and prevent accidental displacement when in transit. Finished zinc plated.



| Description | H x W x D (mm) | Order Ref | Price (Each) |
|--------------------------------------|-----------------|-----------|--------------|
| FLEX-BIN No. 3 (inc. 2 Dividers) | 150 x 302 x 140 | 051399 | £16.00 |
| Retaining Bar for FLEX-BIN No.3 Only | - | 051091 | £0.85 |
| FLEX-BIN No. 7 (inc. 6 Dividers) | 150 x 601 x 140 | 051400 | £20.95 |
| Retaining Bar for FLEX-BIN No.7 Only | - | 051090 | £1.90 |

Labels Supplied / Excludes wall fixings

Topstore - Clearbox Mini-bins

SMALL AND COMPACT

The Clearbox Mini-Bin is an ideal solution for storing small items at home, at the office, in stores or in manufacturing and assembly operations.

MODULAR DESIGN

Clearbox Mini-Bins are modular in design with the option of adding additional units as storage requirements grow. Interlocking ribs on all four sides, allow multiple attachment configurations for a custom-made storage solution. Supplied with red carcass and clear inner compartment.

| Description | H x W x D (mm) | Order Ref | Price (Pack) |
|-----------------------|----------------|-----------|--------------|
| MINI-BIN (Pack of 16) | 77 x 75 x 65 | 051300 | £23.20 |
| MINI-BIN (Pack of 40) | 77 x 75 x 65 | 051301 | £52.90 |

Labels Supplied / Excludes wall fixings



Topstore - Flexi Store

Multi Drawer Units - Small

- Tough Styrene construction, finished in black with translucent drawers.
- Free standing or wall mounted (wall fixings not included).
- Overall dimensions: (H) 210 x (W) 270 x (D) 130mm.
- Multi drawers in 2 sizes.
Small: (H) 35 x (W) 60 x (D) 105mm
Medium: (H) 35 x (W) 120 x (D) 105mm



| Description | No. of drawers | | | Pack Qty | Order Ref | Price (Per Pack) |
|----------------|----------------|--------|--|----------|-----------|------------------|
| | Small | Medium | | | | |
| 16 Drawer Unit | 12 | 4 | | 6 | 216/6 | £55.04 |
| 20 Drawer Unit | 20 | - | | 6 | 220/6 | £55.04 |

Multi Drawer Units - Large

- Tough Polypropylene construction, finished in black with translucent drawers.
- Free standing or wall mounted (wall fixings not included).
- Overall dimensions: (H)420 x (W) 270 x (D) 130mm.
- Multi drawers in 3 sizes.
Small: (H) 35 x (W) 60 x (D) 105mm
Medium: (H) 35 x (W) 120 x (D) 105mm
Large: (H) 35 x (W) 260 x (D) 105mm



| Description | No. of drawers | | | Pack Qty | Order Ref | Price (Per Pack) |
|----------------|----------------|--------|-------|----------|-----------|------------------|
| | Small | Medium | Large | | | |
| 30 Drawer Unit | 24 | 4 | 2 | 3 | 130/3 | £52.24 |
| 40 Drawer Unit | 40 | - | - | 3 | 140/3 | £52.24 |

Modular Bin Trays

- Tough polypropylene construction, finished in blue.
- Free standing or wall mounted (wall fixings not included).
- Available in 3 sizes, can be used in conjunction with each other.

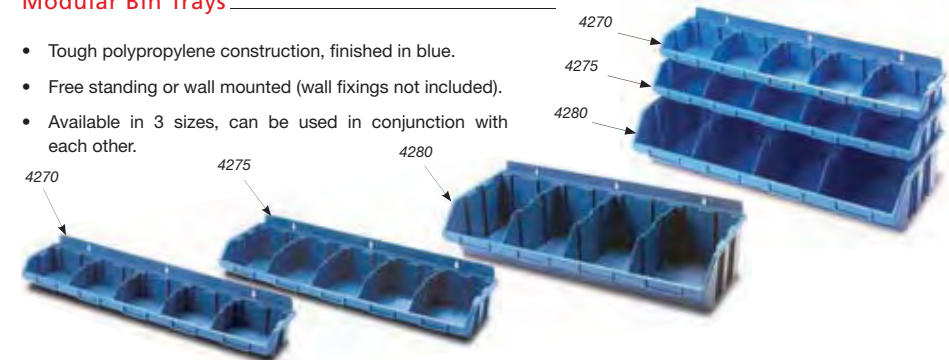

| Description | Overall H x W x D (mm) | No. of Compartments | Compartments H x W x D (mm) | Pack Qty | Order Ref | Price (Per Pack) |
|-----------------|------------------------|---------------------|-----------------------------|----------|-----------|------------------|
| Small Bin Tray | 85 x 600 x 130 | 5 | 50 x 105 x 75 | 24 | 4270/24 | £92.16 |
| Medium Bin Tray | 100 x 600 x 165 | 5 | 70 x 110 x 110 | 15 | 4275/15 | £77.44 |
| Large Bin Tray | 160 x 600 x 260 | 4 | 140 x 120 x 160 | 6 | 4280/6 | £54.76 |

Cantilever Organiser Case

- Tough polypropylene construction, finished in Black and Natural grade.
- Sturdy clips and handle.
- Steel hinged tray.
- Overall dimensions: (H) 100 x (W) 340 x (D) 270mm
- Large base storage area, dimensions: (H) 70 x (W) 340 x (D) 245mm
- Cantilevered tray includes 5 compartments in 2 sizes
 - 4 x (H) 35 x (W) 80 x (D) 120mm
 - 1 x (H) 35 x (W) 320 x (D) 60mm



| Description | Pack Qty | Order Ref | Price (Per Pack) |
|---------------------------|----------|-----------|------------------|
| Cantilever Organiser Case | 8 | 051/8 | £57.38 |

Portable Parts Organisers

- Ideal for small parts organisation.
- Tough polypropylene construction, finished in Black and Natural grade.
- Available with 9, 10 and 12 compartments.
- Transparent lid to view contents.
- Spill proof and Sturdy clip
- Overall dimensions: (H) 55 x (W) 324 x (D) 230mm
- Compartments dimensions (mm) : see illustrations

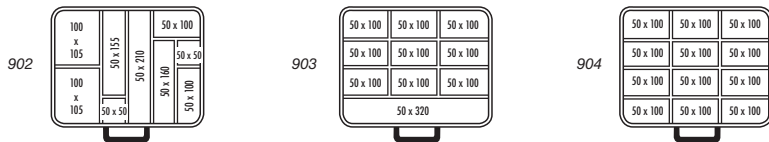

| Description | No. of compartments | Pack Qty | Order Ref | Price (Per Pack) |
|---------------------------|---------------------|----------|-----------|------------------|
| Portable Parts Organisers | 9 | 10 | 902/10 | £66.94 |
| | 10 | 10 | 903/10 | £66.94 |
| | 12 | 10 | 904/10 | £66.94 |

Topstore - Container Trolleys

A strong yet lightweight trolley designed to carry either NXT GEN, TC Topstore containers, mesh baskets or spigots and the container trolley is fitted with a top shelf.

Attractively finished in epoxy powder coated silver/grey frame, would ideally be suited for any stores, office, workshop or warehouse.

Wheels are all 100mm diameter swivel vulcanised blue rubber, offering low rolling resistance, meaning they are easy to manoeuvre, are non marking and soft yet highly durable.



- Trolley Height: 1300mm
- Trolley Depth: 500mm
- Trolley Width: 500mm
- Max Trolley Capacity: 200kg

See page 5 for Topstore TC Container capacities

Fitted complete with a welded TP2 louvered panel. See pages 8 and 9 for full details.

| Product Description | Braked Trolleys | | Unbraked Trolleys | |
|--|-----------------|-------------|-------------------|-------------|
| | Order Ref | Price (Kit) | Order Ref | Price (Kit) |
| Container Trolley without Containers | CT/BC | £225.00 | CT | £215.00 |
| Container Trolley with 5 x TC6 Blue Containers | CT/5XTC6B/BC | £295.00 | CT/5XTC6B | £285.00 |
| Container Trolley with 5 x TC6 Red Containers | CT/5XTC6R/BC | £295.00 | CT/5XTC6R | £285.00 |
| Container Trolley with 5 x TC6 White Containers | CT/5XTC6E/BC | £295.00 | CT/5XTC6E | £285.00 |
| Container Trolley with 10 x TC5 Blue Containers | CT/10XTC5B/BC | £305.00 | CT/10XTC5B | £295.00 |
| Container Trolley with 10 x TC5 Red Containers | CT/10XTC5R/BC | £305.00 | CT/10XTC5R | £295.00 |
| Container Trolley with 10 x TC5 White Containers | CT/10XTC5E/BC | £305.00 | CT/10XTC5E | £295.00 |
| Container Trolley with 18 x TC3 Blue Containers | CT/18XTC3B/BC | £285.00 | CT/18XTC3B | £275.00 |
| Container Trolley with 18 x TC3 Red Containers | CT/18XTC3R/BC | £285.00 | CT/18XTC3R | £275.00 |
| Container Trolley with 18 x TC3 White Containers | CT/18XTC3E/BC | £285.00 | CT/18XTC3E | £275.00 |
| Container Trolley with 12 x TC4 Blue Containers | CT/12XTC4B/BC | £290.00 | CT/12XTC4B | £280.00 |
| Container Trolley with 12 x TC4 Red Containers | CT/12XTC4R/BC | £290.00 | CT/12XTC4R | £280.00 |
| Container Trolley with 12 x TC4 White Containers | CT/12XTC4E/BC | £290.00 | CT/12XTC4E | £280.00 |
| Container Trolley with 3 x Wire Mesh Baskets (460 x 330 x 200mm) | CT/3XLWB/BC | £365.00 | CT/3XLWB | £355.00 |

N.B. Prices include 1 - I.D. label per bin



Topstore - Container Trolleys

An extended range of Container Trolleys fitted with a smaller louvred panel and 3 x fixed lipped trays to prevent stored items from slipping off. The trolley can either be supplied as complete kits with TC bins included or empty to suit individual requirements. (Please contact our Sales Department for further details).

Wheels are all 100mm diameter swivel vulcanised blue rubber, offering low rolling resistance, meaning they are easy to manoeuvre, are non marking and soft yet highly durable.

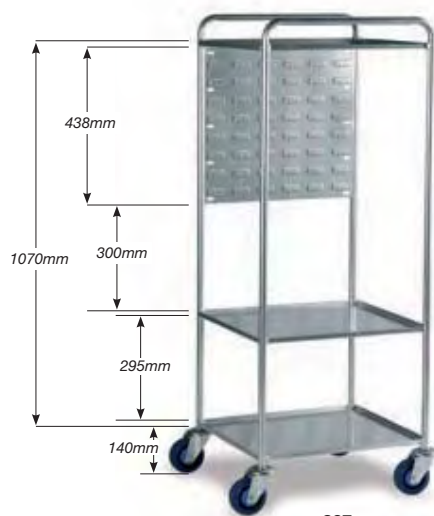

CST



CST Shelf/Tray
Tray size: W500 x D455mm

Trolley Height: 1300mm
Trolley Depth: 500mm
Trolley Width: 500mm
Max Trolley Capacity: 200kg

See page 5 for Topstore TC Container capacities

Fitted complete with a welded TP1 louvred panel. See pages 8 and 9 for full details.

| Product Description | Braked Trolleys | | Unbraked Trolleys | |
|--|-----------------|-------------|-------------------|-------------|
| | Order Ref | Price (Kit) | Order Ref | Price (Kit) |
| Container Trolley Empty c/w 3 x Fixed Shelves | CST/BC | £265.00 | CST | £255.00 |
| Container Trolley c/w 4 x TC5 Blue & 3 x Fixed Shelves | CST/4XTC5B/BC | £285.00 | CST/4XTC5B | £275.00 |
| Container Trolley c/w 4 x TC5 Red & 3 x Fixed Shelves | CST/4XTC5R/BC | £285.00 | CST/4XTC5R | £275.00 |
| Container Trolley c/w 2 x TC6 Blue & 3 x Fixed Shelves | CST/2XTC6B/BC | £285.00 | CST/2XTC6B | £275.00 |
| Container Trolley c/w 2 x TC6 Red & 3 x Fixed Shelves | CST/2XTC6R/BC | £285.00 | CST/2XTC6R | £275.00 |

N.B. Prices include 1 - I.D. label per bin



CST/4XTC5B

CST/4XTC5R

CST/2XTC6B

CST/2XTC6R

Topstore - Angled Container Trolley

An ideal way to transport small parts using either the Topstore TC Container range or Topstore Euro Container.

Its design offers easy access to all containers. Attractively finished in epoxy powder coated silver/grey frame, would ideally be suited for any stores, office, workshop or warehouse.

Wheels are 100mm diameter, all swivel vulcanised blue rubber, offering low rolling resistance, meaning they are easy to manoeuvre, are non marking and soft yet highly durable.



ACT/3XTC6B

ACT/3XEC

Trolley Height: 1030mm
Trolley Depth: 830mm
Trolley Width: 500mm
Max Trolley Capacity: 200kg

See page 5 for Topstore TC Container capacities.

See page 32 for Euro Container capacities.

| Product Description | Braked Trolleys | | Unbraked Trolleys | |
|--|-----------------|-------------|-------------------|-------------|
| | Order Ref | Price (Kit) | Order Ref | Price (Kit) |
| Angled Container Trolley without Containers | ACT/BC | £220.00 | ACT | £205.00 |
| Angled Container Trolley with 3 x TC6 Blue Containers | ACT/3XTC6B/BC | £245.00 | ACT/3XTC6B | £235.00 |
| Angled Container Trolley with 3 x TC6 Red Containers | ACT/3XTC6R/BC | £245.00 | ACT/3XTC6R | £235.00 |
| Angled Container Trolley with 3 x TC6 White Containers | ACT/3XTC6E/BC | £245.00 | ACT/3XTC6E | £235.00 |
| Angled Container Trolley with 2 x (400 x 300 x 220) & 1 x (600 x 400 x 200mm) Grey Euro Containers | ACT/3XEC/BC | £265.00 | ACT/3XEC | £255.00 |

N.B. Prices include 1 - I.D. label for TC containers only

Topstore - Double Container Trolley

Designed to carry four 24 litre natural grade polypropylene storage containers and lids. Eliminates the need to carry heavy boxes and also saves time by allowing 4 to be transported at any one time.

Wheels are 100mm diameter, all swivel vulcanised blue rubber, offering low rolling resistance, meaning they are easy to manoeuvre, are non marking and soft yet highly durable. Finish: Silver/Grey epoxy powder coated.



DCT/4X24L

Trolley Height: 1030mm
Trolley Depth: 840mm
Trolley Width: 480mm
Container Capacity: 15kg each
Max Trolley Capacity: 200kg

| Product Description | Braked Trolleys | | Unbraked Trolleys | |
|---|-----------------|-------------|-------------------|-------------|
| | Order Ref | Price (Kit) | Order Ref | Price (Kit) |
| Double Container Trolley without Containers | DCT/BC | £205.00 | DCT | £197.74 |
| Double Container Trolley with 4 x 24 Litre Plastic Containers | DCT/4X24L/BC | £230.00 | DCT/4X24L | £220.75 |

Topstore – Euro Container Tray Trolleys

A choice of pre-kitted trolleys available complete with removable Euro Containers.

- Fully welded steel construction
- Handles fitted to aid manoeuvrability
- Rear straps fitted to act as a safety stop when fitting Euro Containers
- Epoxy powder coated silver/grey frame
- Wheels are all 100mm diameter swivel vulcanised blue rubber, offering low rolling resistance, meaning they are easy to manoeuvre, are non marking and soft yet highly durable.
- Braked or unbraked trolleys available



Euro container sizes: (L x W x H)

E6412-11 (Ext: 600 x 400 x 120mm) (Int: 555 x 355 x 112mm)

E6417-11 (Ext: 600 x 400 x 170mm) (Int: 555 x 355 x 158mm)

E6420-11 (Ext: 600 x 400 x 200mm) (Int: 555 x 355 x 187mm)

Trolley Height: 1500mm

Trolley Depth: 700mm

Trolley Width: 470mm

Max Trolley Capacity: 250kg

| Product Description | Braked Trolleys | | Unbraked Trolleys | |
|--|-----------------|-------------|-------------------|-------------|
| | Order Ref | Price (Kit) | Order Ref | Price (Kit) |
| 8 Tier - Euro Container Trolley c/w 8 x E6412-11 | ECT/8X6412/BC | £375.00 | ECT/8X6412 | £365.00 |
| 6 Tier - Euro Container Trolley c/w 6 x E6417-11 | ECT/6X6417/BC | £360.00 | ECT/6X6417 | £350.00 |
| 6 Tier - Euro Container Trolley c/w 6 x E6420-11 | ECT/6X6420/BC | £370.00 | ECT/6X6420 | £360.00 |



ECT/8X6412

ECT/6X6417

ECT/6X6420

STORAGE / SHELVING EQUIPMENT

A comprehensive range of wall and floor mounted shelving and racking to suit light, medium and heavy duty applications.

| Product | Lead Time (Working Days) | Page |
|---|-----------------------------|------|
| Toptube - Square Tube Shelving System | (7-10) | 42 |
| Topshelf - Wall Mounted Shelving | (7) | 43 |
| Topshelf - Wall Mounted Shelving - Plastic Shelving . . . (5-7) | | 44 |
| Modular Plastic Shelving Units | (5-7) | 45 |
| Toprax - Bolt Free Adjustable Shelving Kits | (5-7) | 46 |
| Toprax - Standard Kit Prices | (5-7) | 48 |
| Toprax - Standard Bay Shelving c/w TC Bin Kits | (5-7) | 49 |
| Toprax - Container Kits | (5-7) | 50 |
| Toprax - Garment Hanging | (5-7) | 51 |
| Toprax - Longspan Kits | (5-7) | 52 |
| Toprax - Longspan Bay Shelving c/w TC Bin Kits | (5-7) | 53 |
| Quickshelf - Bolt Free Adjustable Shelving | (5-7) | 54 |
| Quickshelf - Complete Bays - TC Bin Kits | (5-7) | 56 |
| Chrome Shelving | (7-10) | 58 |
| Chrome Basket Trolley | (5-7) | 58 |
| Bartspan - Longspan Shelving | (*See below) | 60 |
| * Express Range - Items marked E | (7-10) | |
| * Standard Range - Items unmarked | (Please enquire) | |
| Adjustable Cantilever Racking | (10-20) | 62 |
| Bartrak - Adjustable Pallet Racking | (Please enquire) | 63 |
| Topmesh - Anti Collapse | (Please enquire) | 64 |

Toptube - Square Tube Shelving System

The square tube system uses both joints and accessories that interlock with the tube to create your own individual designs. Custom built designs can vary from workstations, partitioning, benches, trolleys, shelving, desks, etc.

Square Tube

25mm square tube, finished in epoxy powder coated black and available in lengths of 3000mm. Wall thickness 1.2mm.



Square Tube

| | |
|------------------|----------|
| Order Ref | TZ3TB/10 |
| Pack Qty | 10 |
| Price (Per Pack) | £128.60 |

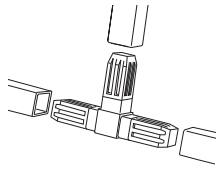

Seven Joints/Connectors

A range of seven black joints/connectors to suit individual requirements. Manufactured from nylon 6 base material, glass filled fibre strand and impact modifier to provide strength and rigidity.



| | 2 Way Joint | 3 Way Joint | 3 Way Flat Joint | 4 Way Joint | 4 Way Flat Joint | 5 Way Joint | 6 Way Joint |
|------------------|-------------|-------------|------------------|-------------|------------------|-------------|-------------|
| Order Ref | TZ2W/10 | TZ3W/10 | TZ3WF/10 | TZ4W/10 | TZ4WF/10 | TZ5W/10 | TZ6W/10 |
| Pack Qty | 10 | 10 | 10 | 10 | 10 | 10 | 10 |
| Price (Per Pack) | £50.40 | £57.40 | £57.40 | £63.30 | £63.30 | £72.80 | £76.30 |

Accessories

| Descriptions | ADJUSTABLE FEET | ANCHOR BASE PLATE | WHEEL (SWIVEL) | SHELF CUP | FLANGE PLATE | PLASTIC END CAP | CUTTING JIG |
|------------------|---|--|---|---|--|--------------------------------------|--------------------------------|
| | Black plastic foot including cap, which can be tapped into tube | 76mm square steel plate welded to plain tube, used for fixing structures to floors, walls and ceilings. (Fixings not supplied) | 100mm Diameter rubber tyred in grey. Capacity per 4 - 160Kg | Used to retain 15mm thick board. These secure shelving inside flush with the top of horizontal tube | Bright zinc plated cover which enables fixing the adjustable foot to floor. (Fixings not supplied) | Used to finish the end of a cut tube | Assists in cutting square tube |
| | | | | | | | |
| Order Ref | TZAFS/40 | TZBPI/25 | TZLDW/2 | TZSCL/12 | TZFCP/80 | TZPEC/12 | Cutting Jig |
| Pack Qty | 40 | 40 | 2 | 12 | 80 | 12 | 1 |
| Price (Per Pack) | £80.80 | £89.00 | £39.50 | £28.00 | £79.80 | £25.90 | £15.62 |

Easy Construction

Simply sketch out your design and work out the quantities of square tube/joints required. Cut the tube using the Cutting Jig to obtain a perfect fit, knock together using the appropriate joints.

Step 1 - Sketch your requirements

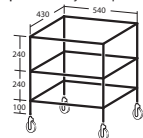

Step 2 - Cut to suit



Step 3 - Fix into position



Step 4 - Finished product



Topshelf - Wall Mounted Shelving

Topshelf is an attractive and durable wall mounted steel shelving system that is fully adjustable in height to suit almost every need. Supplied epoxy powder coated in white, Topshelf gives a fresh look to any environment.

Topshelf is a must for any workshop, factory or office. Each shelf is 1 metre wide and is supplied in a range of depths for many applications.

- Extension kits add on to starter kits using the existing upright and bracket.
- Shelf capacity - 50kg (UDL).
- Upright slot pitch - 30mm



Book End



020786S

Topshelf - Complete Kits

Topshelf - Standard Components

| Description | Quantity per Pack | Order Ref | Price (Per Pack) |
|---|-------------------|-----------|------------------|
| Topshelf Slotted Upright, White, 1048mm Long | 2 | 020703/2 | £13.37 |
| Topshelf Slotted Upright, White, 1524mm Long | 2 | 020705/2 | £18.27 |
| Topshelf Shelving Bracket, White, 220mm | 8 | 020713/8 | £19.92 |
| Topshelf Shelving Bracket, White, 270mm | 8 | 020723/8 | £23.24 |
| Topshelf Shelving Bracket, White, 320mm | 8 | 020715/8 | £26.08 |
| Topshelf Shelving Bracket, White, 370mm | 8 | 020727/8 | £32.48 |
| Topshelf Wall Mounted Shelf, White, 1m x 220mm | 4 | 020733/4 | £68.56 |
| Topshelf Wall Mounted Shelf, White, 1m x 270mm | 4 | 020743/4 | £77.61 |
| Topshelf Wall Mounted Shelf, White, 1m x 320mm | 4 | 020735/4 | £87.70 |
| Topshelf Wall Mounted Shelf, White, 1m x 370mm | 4 | 020737/4 | £94.68 |
| Topshelf Bookend / Shelf End Support, White, 150mm Sq | 2 | 020747/2 | £10.58 |

Topshelf - Kits

| Description | Shelf Depths | | | | | | | |
|--|--------------|-----------------|-----------|-----------------|-----------|-----------------|-----------|-----------------|
| | 220mm | | 270mm | | 320mm | | 370mm | |
| | Order Ref | Price (Per Kit) | Order Ref | Price (Per Kit) | Order Ref | Price (Per Kit) | Order Ref | Price (Per Kit) |
| Topshelf Starter Unit (4 Shelves) H 1048 x W 1000mm | 020781S | £92.30 | 020775S | £102.55 | 020787S | £120.00 | 020790S | £130.00 |
| Topshelf Extension Unit (4 Shelves) H 1048 x W 1000mm | 020781E | £83.26 | 020775E | £95.86 | 020787E | £110.00 | 020790E | £120.00 |
| Topshelf Starter Unit (4 Shelves) H 1524 x W 1000mm | 020782S | £105.90 | 020785S | £107.52 | 020788S | £125.00 | 020791S | £135.00 |
| Topshelf Extension Unit (4 Shelves) H 1524 x W 1000mm | 020782E | £90.00 | 020785E | £91.90 | 020788E | £115.00 | 020791E | £125.00 |
| Topshelf Starter Unit (4 Shelves) H 1524 x W 1000mm c/w 8 Bookends | 020783S | £135.00 | 020786S | £147.84 | 020789S | £145.00 | 020792S | £155.00 |
| Topshelf Extension Unit (4 Shelves) H 1524 x W 1000mm c/w 4 Bookends | 020783E | £110.00 | 020786E | £112.67 | 020789E | £120.00 | 020792E | £130.00 |

Excludes wall fixings

Topshelf - Wall Mounted Shelving - Plastic Shelving

A unique lightweight wall mounted shelving system constructed from black polypropylene with the option of various layout combinations. The uprights are designed for the shelves to simply lock into position at the preferred level and can be adjusted very quickly when required.

Features

- Shelf Capacity - 30 or 50 kg (UDL)
- Upright slot pitch - 55mm
- Supplied in packs of 2
- Components in each pack include 4 x uprights and 2 x shelves

Excludes wall fixings.

Layout examples for each pack



6025WBLK

8025WBLK

| Description | L x W (mm) | Loading Weight (kg) per shelf | Order ref | Price (per pack) |
|-------------------------------|------------|-------------------------------|------------|------------------|
| Plastic Wall Mounted Shelving | 600 x 250 | 30 | 6025WBLK/2 | £37.10 |
| Plastic Wall Mounted Shelving | 800 x 250 | 50 | 8025WBLK/2 | £51.94 |

Modular Plastic Shelving Units

Modular Plastic Shelving unit is a low-cost shelving system suitable for the storage of light duty items, which can be used to satisfy storage requirements in almost any environment.

Features

- Manufactured from black polypropylene.
- Each unit consists 3, 4, or 5 shelves.
- Shelf capacity 30 or 90 kg (UDL).
- Connection between shelves through the lateral joints provided.
- Can be fixed to the wall (wall fixing brackets supplied), excludes wall fixings.
- Quick and easy to assemble.

Plastic Shelving Kits

| Description | H x W x D (mm) | Loading Weight (kg) per shelf | Order ref | Price (each) |
|--|------------------|-------------------------------|-----------|--------------|
| 3 Tier Shelving | 963 x 600 x 300 | 30 | 6033 | £19.29 |
| 4 Tier Shelving | 1395 x 600 x 300 | 30 | 6034 | £24.49 |
| 5 Tier Shelving | 1825 x 600 x 300 | 30 | 6035 | £30.24 |
| 3 Tier Shelving | 968 x 900 x 400 | 90 | 9043 | £31.91 |
| 4 Tier Shelving | 1400 x 900 x 400 | 90 | 9044 | £40.07 |
| 5 Tier Shelving | 1840 x 900 x 400 | 90 | 9045 | £48.23 |
| 5 Tier Shelving c/w 8 x 24L Containers | 1840 x 900 x 400 | 90 | 9045/24L | £94.23 |
| 5 Tier Shelving c/w 8 x 35L Containers | 1840 x 900 x 400 | 90 | 9045/35L | £117.98 |



9045/24L

6034

6033

9045/35L

6033

Toprax - Bolt Free Adjustable Shelving

Toprax is a high quality, fully adjustable bolt-free shelving system, requiring no special fixings. It combines the strength necessary to meet the specifications for commercial and industrial storage applications, whilst the unpierced face of the uprights and beams provide the style and elegance required for the office environment.

Clean, fully tooled components ensure the complete absence of sharp edges to safeguard you and your goods from damage.

The unique design of Toprax allows clear, unlimited entry, as there are no cross braces or gussets to restrict the loading of shelves or the selection of products.

The system can incorporate Topstore bins and is capable of being fitted with accessories to make the system suitable for garment hanging. The bays can be clad on the sides and rear with mesh or steel panels to make this one of the most flexible systems available.

A wide choice of frames and shelves are available. Shelves are fully adjustable on 50mm (2") centres and bays can be extended as required to cater for fluctuating stock and change in products.

For added convenience and faster installation, all units are supplied with full instructions for self-assembly.

Uprights are finished epoxy powder coated blue (as standard), beams and ties are epoxy powder coated silver/grey and shelves are galvanised as standard (other colours are available upon request, refer to choice on page 47).



Standard Single Bay

Toprax - Bolt Free Adjustable Shelving

Flexibility

The flexibility, strength and stability of Toprax enables the system to be fitted with a range of accessories for varying storage requirements.

Garment Hanging

Using standard frame ties with specially designed brackets, and two diameters of hanging rail for differing sizes of hangers. It is an ideal way for the storage of clothing and other garments.

The system is totally flexible and can be fully adjusted to accommodate additional levels for fluctuating storage requirements.

Cable Reel Dispensing

Using the same principle as Garment Hanging, the Toprax Cable Reel System is an extremely effective way of storing cable reels and offers quick dispensing with minimum of effort. Replacing empty cable reels is quick and easy as the cable reel support can simply be lifted from the bracket enabling quick changeover.

The special design of the hanging rail bracket allows full adjustment when unloaded. When loaded, the support bar can be firmly secured in place preventing unnecessary movement.

The system is totally flexible and can be fully adjusted to accommodate additional levels for fluctuating storage requirements.

Cladding

Toprax also offers the option for rear and side cladding. Available in either a 50 x 50mm mesh grid or galvanised steel sheet, for effective segregation of bays.



Garment Hanging



Standard Single Bay + Extension Bay



Double Bay



Cable Reel Dispensing



Cladding - Mesh Sides / Steel Rear



Upright Colour Options

This option will only be considered on higher volume orders. Please check with the Sales Department.

Design and Planning Service

We offer a free design and planning service to assist you with every phase of your storage requirements. Installation teams are available for the larger, more complex schemes to ensure that your new storage equipment is in operation as quickly as possible with the minimum of disruption to your day to day activities.

Toprax - Standard Kit Prices

Standard Initial Single Bays

| Description | Shelf Depth | Overall Depth | 942mm Overall Width | | 1042mm Overall Width | |
|--|-------------|---------------|---------------------|---------|----------------------|---------|
| | | | Order Ref | Price | Order Ref | Price |
| 1500mm High Single Bays c/w 5 x Shelves | 290mm | 328mm | 022410SI | £190.82 | 022490SI | £201.28 |
| | 440mm | 478mm | 022430SI | £215.53 | 022510SI | £229.33 |
| 2000mm High Single Bays c/w 5 x Shelves | 290mm | 328mm | 023410SI | £203.58 | 023490SI | £214.04 |
| | 440mm | 478mm | 023430SI | £228.29 | 023510SI | £242.09 |

Standard Extension Single Bays

| Description | Shelf Depth | Overall Depth | 910mm Overall Width | | 1010mm Overall Width | |
|--|-------------|---------------|---------------------|---------|----------------------|---------|
| | | | Order Ref | Price | Order Ref | Price |
| 1500mm High Single Bays c/w 5 x Shelves | 290mm | 328mm | 022410SE | £146.60 | 022490SE | £157.07 |
| | 440mm | 478mm | 022430SE | £169.53 | 022510SE | £183.33 |
| 2000mm High Single Bays c/w 5 x Shelves | 290mm | 328mm | 023410SE | £152.99 | 023490SE | £163.45 |
| | 440mm | 478mm | 023430SE | £175.91 | 023510SE | £189.71 |

Standard Initial Double Bays

| Description | Shelf Depth | Overall Depth | 942mm Overall Width | | 1042mm Overall Width | |
|---|-------------|---------------|---------------------|---------|----------------------|---------|
| | | | Order Ref | Price | Order Ref | Price |
| 1500mm High Double Bays c/w 10 x Shelves | 2 x 290mm | 625mm | 022410DI | £333.31 | 022490DI | £352.90 |
| | 2 x 440mm | 925mm | 022430DI | £382.72 | 022510DI | £408.99 |
| 2000mm High Double Bays c/w 10 x Shelves | 2 x 290mm | 625mm | 023410DI | £352.45 | 023490DI | £372.04 |
| | 2 x 440mm | 925mm | 023430DI | £401.87 | 023510DI | £428.13 |

Standard Extension Double Bays

| Description | Shelf Depth | Overall Depth | 910mm Overall Width | | 1010mm Overall Width | |
|---|-------------|---------------|---------------------|---------|----------------------|---------|
| | | | Order Ref | Price | Order Ref | Price |
| 1500mm High Double Bays c/w 10 x Shelves | 2 x 290mm | 625mm | 022410DE | £262.10 | 022490DE | £281.69 |
| | 2 x 440mm | 925mm | 022430DE | £307.95 | 022510DE | £334.22 |
| 2000mm High Double Bays c/w 10 x Shelves | 2 x 290mm | 625mm | 023410DE | £271.67 | 023490DE | £291.26 |
| | 2 x 440mm | 925mm | 023430DE | £317.52 | 023510DE | £343.79 |

Standard Initial Bays c/w 15 x 24 Ltr. Containers

| Description | Shelf Depth | Overall Depth | 1042mm Overall Width | |
|---|-------------|---------------|----------------------|---------|
| | | | Order Ref | Price |
| 1500mm High Single Bays c/w 5 x Shelves and 15 x 24 Ltr. Containers | 440mm | 478mm | 023355SIPC | £315.59 |

Standard Extension Bays c/w 15 x 24 Ltr. Containers

| Description | Shelf Depth | Overall Depth | 1010mm Overall Width | |
|---|-------------|---------------|----------------------|---------|
| | | | Order Ref | Price |
| 1500mm High Single Bays c/w 5 x Shelves and 15 x 24 Ltr. Containers | 440mm | 478mm | 023355SEPC | £269.59 |

Max shelf capacities: (UDL) 870 x 290 = 160kg each | 970 x 290 = 150kg each
870 x 440 = 160kg each | 970 x 440 = 150kg each

Floor fixing is required where shelving bays exceed a height to depth ratio of 4:1



023410SI + 023410SE
Initial Single Bay and Extension Single Bay



022410DI + 022410DE



023355SIPC + 023355SEPC

Toprax - Standard Bay Shelving c/w TC Bin Kits

- Fully adjustable bolt free pre-kitted system
 - TC container colour options in blue, red, green or yellow
 - Other options available, please contact our Sales Department
 - Overall standard bay size H1500 x W942 x D328 mm / double bay D625mm
 - Shelf size W870 x D290 mm
- TC container sizes:** (L x W x H)
TC4: 350 x 205 x 132mm
TC5: 350 x 205 x 182mm
TC6: 375 x 420 x 182mm

| Description | Order ref | | | | Price |
|--|---------------|---------------|---------------|---------------|---------|
| | Blue Bins | Red Bins | Green Bins | Yellow Bins | |
| Standard Bays | | | | | |
| Standard Initial Bay c/w 40 x TC4 Bins & 5 shelves | 022410SI/TC4B | 022410SI/TC4R | 022410SI/TC4G | 022410SI/TC4Y | £296.11 |
| Standard Extension Bay c/w 40 x TC4 Bins & 5 shelves | 022410SE/TC4B | 022410SE/TC4R | 022410SE/TC4G | 022410SE/TC4Y | £250.00 |
| Double Initial Bay c/w 80 x TC4 Bins & 10 shelves | 022410DI/TC4B | 022410DI/TC4R | 022410DI/TC4G | 022410DI/TC4Y | £530.00 |
| Double Extension Bay c/w 80 x TC4 Bins & 10 shelves | 022410DE/TC4B | 022410DE/TC4R | 022410DE/TC4G | 022410DE/TC4Y | £460.00 |
| Standard Initial Bay c/w 28 x TC5 Bins & 3 shelves | 022410SI/TC5B | 022410SI/TC5R | 022410SI/TC5G | 022410SI/TC5Y | £273.17 |
| Standard Extension Bay c/w 28 x TC5 Bins & 3 shelves | 022410SE/TC5B | 022410SE/TC5R | 022410SE/TC5G | 022410SE/TC5Y | £225.00 |
| Double Initial Bay c/w 56 x TC5 Bins & 6 shelves | 022410DI/TC5B | 022410DI/TC5R | 022410DI/TC5G | 022410DI/TC5Y | £490.00 |
| Double Extension Bay c/w 56 x TC5 Bins & 6 shelves | 022410DE/TC5B | 022410DE/TC5R | 022410DE/TC5G | 022410DE/TC5Y | £420.00 |
| Standard Initial Bay c/w 14 x TC6 Bins & 3 shelves | 022410SI/TC6B | 022410SI/TC6R | 022410SI/TC6G | 022410SI/TC6Y | £257.27 |
| Standard Extension Bay c/w 14 x TC6 Bins & 3 shelves | 022410SE/TC6B | 022410SE/TC6R | 022410SE/TC6G | 022410SE/TC6Y | £210.00 |
| Double Initial Bay c/w 28 x TC6 Bins & 6 shelves | 022410DI/TC6B | 022410DI/TC6R | 022410DI/TC6G | 022410DI/TC6Y | £460.00 |
| Double Extension Bay c/w 28 x TC6 Bins & 6 shelves | 022410DE/TC6B | 022410DE/TC6R | 022410DE/TC6G | 022410DE/TC6Y | £385.00 |

Max shelf capacity: 160kg each (UDL)
N.B. Prices include 1 - I.D. label per bin



022410SI/TC5Y

022410SI/TC4R

Floor fixing is required where shelving bays exceed a height to depth ratio of 4:1

022410DI/TC6B

Toprax - Container Kits

Space Bin Container Kits

An ideal storage solution for storage of larger products or multiple storage of bulk items. Large open fronted bins allows easy access for stored products.

Containers are both stackable and nestable when not in use.

Please refer to page 30 for full details on bin sizes/capacities.

- Available with 2 shelf levels
- Shelf size W970 x D440mm



022510SI/SB

| Description | Overall Size H x W x D (mm) | Order Ref | Price |
|---|--------------------------------|-------------|---------|
| Standard Initial Bay c/w 8 Space Bin Containers | 1500 x 1042 x 478 | 022510SI/SB | £245.00 |
| Standard Extension Bay c/w 8 Space Bin Containers | 1500 x 1010 x 478 | 022510SE/SB | £200.00 |
| Double Initial Bay c/w 16 Space Bin Containers | 1500 x 1042 x 925 | 022510DI/SB | £435.00 |
| Double Extension Bay c/w 16 Space Bin Containers | 1500 x 1010 x 925 | 022510DE/SB | £340.00 |

Max load capacity: 260kg (UDL) per shelf level

Floor fixing is required where shelving bays exceed a height to depth ratio of 4:1

Multi-Functional Container Kits

An alternative storage system which uses containers complete with lids, keeping stored items dust free. Ideal in schools, offices, workshops, garages etc. Different kit options are available using containers with single coloured hinged lids and options with mixed coloured lids in blue, red, green and yellow (supplied in equal quantities). The mixed colour lid option is ideal for product segregation.

These containers are both stackable with or without lids and nestable when not in use.

Please refer to page 31 for full details on bin sizes/capacities.

- Available with 2 shelf levels
- Shelf size W870 x D440mm



022430DI/MMF

| Description | Overall Size H x W x D (mm) | Order Ref | Price |
|--|--------------------------------|--------------|---------|
| Standard Initial Bay c/w 8 Multi-Functional Containers - Blue Lids | 1500 x 942 x 478 | 022430SI/BMF | £345.00 |
| Standard Extension Bay c/w 8 Multi-Functional Containers - Blue Lids | 1500 x 910 x 478 | 022430SE/BMF | £300.00 |
| Double Initial Bay c/w 16 Multi-Functional Containers - Blue Lids | 1500 x 942 x 925 | 022430DI/BMF | £645.00 |
| Double Extension Bay c/w 16 Multi-Functional Containers - Blue Lids | 1500 x 910 x 925 | 022430DE/BMF | £550.00 |
| Standard Initial Bay c/w 8 Multi-Functional Containers - Red Lids | 1500 x 942 x 478 | 022430SI/RMF | £345.00 |
| Standard Extension Bay c/w 8 Multi-Functional Containers - Red Lids | 1500 x 910 x 478 | 022430SE/RMF | £300.00 |
| Double Initial Bay c/w 16 Multi-Functional Containers - Red Lids | 1500 x 942 x 925 | 022430DI/RMF | £645.00 |
| Double Extension Bay c/w 16 Multi-Functional Containers - Red Lids | 1500 x 910 x 925 | 022430DE/RMF | £550.00 |
| Standard Initial Bay c/w 8 Multi-Functional Containers - Green Lids | 1500 x 942 x 478 | 022430SI/GMF | £345.00 |
| Standard Extension Bay c/w 8 Multi-Functional Containers - Green Lids | 1500 x 910 x 478 | 022430SE/GMF | £300.00 |
| Double Initial Bay c/w 16 Multi-Functional Containers - Green Lids | 1500 x 942 x 925 | 022430DI/GMF | £645.00 |
| Double Extension Bay c/w 16 Multi-Functional Containers - Green Lids | 1500 x 910 x 925 | 022430DE/GMF | £550.00 |
| Standard Initial Bay c/w 8 Multi-Functional Containers - Yellow Lids | 1500 x 942 x 478 | 022430SI/YMF | £345.00 |
| Standard Extension Bay c/w 8 Multi-Functional Containers - Yellow Lids | 1500 x 910 x 478 | 022430SE/YMF | £300.00 |
| Double Initial Bay c/w 16 Multi-Functional Containers - Yellow Lids | 1500 x 942 x 925 | 022430DI/YMF | £645.00 |
| Double Extension Bay c/w 16 Multi-Functional Containers - Yellow Lids | 1500 x 910 x 925 | 022430DE/YMF | £550.00 |
| Standard Initial Bay c/w 8 Multi-Functional Containers - Mixed Lids | 1500 x 942 x 478 | 022430SI/MMF | £345.00 |
| Standard Extension Bay c/w 8 Multi-Functional Containers - Mixed Lids | 1500 x 910 x 478 | 022430SE/MMF | £300.00 |
| Double Initial Bay c/w 16 Multi-Functional Containers - Mixed Lids | 1500 x 942 x 925 | 022430DI/MMF | £645.00 |
| Double Extension Bay c/w 16 Multi-Functional Containers - Mixed Lids | 1500 x 910 x 925 | 022430DE/MMF | £550.00 |

Max load capacity: 260kg (UDL) per shelf level

Floor fixing is required where shelving bays exceed a height to depth ratio of 4:1

Toprax - Garment Hanging

An ideal way for the storage of clothing and other garments. Two options (as shown below) are available, the first option is using standard frame ties with specially designed brackets and 2 hanging rails (32mm diameter), the second option simply uses the frame beams. Compatible with different sized hangers.

The system is totally flexible and can be fully adjusted to accommodate different levels for fluctuating storage requirements.

Hanging Method Section:



023430SI/G + 023430SE/G

023455SI/GH

023455DI/G

| Description | Overall Size H x W x D (mm) | C/W 2 Hanging Rails (Option 1) | | W/O Hanging Rails (Option 2) | |
|------------------------|--------------------------------|--------------------------------|---------|------------------------------|---------|
| | | Order Ref | Price | Order Ref | Price |
| Standard Initial Bay | 2000 x 942 x 478 | 023430SI/GH | £160.00 | 023430SI/G | £140.00 |
| Standard Extension Bay | 2000 x 910 x 478 | 023430SE/GH | £100.00 | 023430SE/G | £85.00 |
| Double Initial Bay | 2000 x 942 x 925 | 023430DI/GH | £260.00 | 023430DI/G | £220.00 |
| Double Extension Bay | 2000 x 910 x 925 | 023430DE/GH | £165.00 | 023430DE/G | £130.00 |
| Standard Initial Bay | 2000 x 942 x 628 | 023435SI/GH | £165.00 | 023435SI/G | £145.00 |
| Standard Extension Bay | 2000 x 910 x 628 | 023435SE/GH | £100.00 | 023435SE/G | £85.00 |
| Double Initial Bay | 2000 x 942 x 1225 | 023435DI/GH | £270.00 | 023435DI/G | £225.00 |
| Double Extension Bay | 2000 x 910 x 1225 | 023435DE/GH | £170.00 | 023435DE/G | £130.00 |
| Standard Initial Bay | 2000 x 1242 x 478 | 023440SI/GH | £170.00 | 023440SI/G | £145.00 |
| Standard Extension Bay | 2000 x 1210 x 478 | 023440SE/GH | £110.00 | 023440SE/G | £90.00 |
| Double Initial Bay | 2000 x 1242 x 925 | 023440DI/GH | £275.00 | 023440DI/G | £230.00 |
| Double Extension Bay | 2000 x 1210 x 925 | 023440DE/GH | £180.00 | 023440DE/G | £140.00 |
| Standard Initial Bay | 2000 x 1242 x 628 | 023445SI/GH | £170.00 | 023445SI/G | £150.00 |
| Standard Extension Bay | 2000 x 1210 x 628 | 023445SE/GH | £110.00 | 023445SE/G | £90.00 |
| Double Initial Bay | 2000 x 1242 x 1225 | 023445DI/GH | £285.00 | 023445DI/G | £235.00 |
| Double Extension Bay | 2000 x 1210 x 1225 | 023445DE/GH | £185.00 | 023445DE/G | £140.00 |
| Standard Initial Bay | 2600 x 942 x 628 | 023450SI/GH | £215.00 | 023450SI/G | £195.00 |
| Standard Extension Bay | 2600 x 910 x 628 | 023450SE/GH | £130.00 | 023450SE/G | £110.00 |
| Double Initial Bay | 2600 x 942 x 1225 | 023450DI/GH | £350.00 | 023450DI/G | £305.00 |
| Double Extension Bay | 2600 x 910 x 1225 | 023450DE/GH | £210.00 | 023450DE/G | £170.00 |
| Standard Initial Bay | 2600 x 1242 x 628 | 023455SI/GH | £225.00 | 023455SI/G | £200.00 |
| Standard Extension Bay | 2600 x 1210 x 628 | 023455SE/GH | £135.00 | 023455SE/G | £115.00 |
| Double Initial Bay | 2600 x 1242 x 1225 | 023455DI/GH | £365.00 | 023455DI/G | £315.00 |
| Double Extension Bay | 2600 x 1210 x 1225 | 023455DE/GH | £225.00 | 023455DE/G | £175.00 |

Max load capacity: For hanging rail (Option 1) - 60Kg(UDL)per rail

For beam hanging (Option 2) - 100Kg(UDL)per beam

(Ensure loads are evenly distributed along the width and depths of bays)

Floor fixing is required where shelving bays exceed a height to depth ratio of 4:1

Toprax - Longspan Shelves

Toprax can also be used as a Longspan shelving system for the storage of longer/larger goods where a standard shelving system would not be suitable.

Based upon the standard Toprax design, it is a cost saving alternative to conventional fully braced longspan systems with a comparable load capacity.

Toprax longspan can be supplied with galvanised steel or chipboard shelves.

- Shelving bays available H 1500mm / H 2000mm
- Shelf sizes W 1740mm x D 290mm / D 440mm
- Available with either 3 or 4 shelf versions



Longspan Bay

For added stability of the beams a Beam Tie is also available.



Beam Tie, Shelf Stop + Steel Shelf

Toprax also offers unrivalled versatility as you can mix standard bays with longspan bays as shown, to offer multiple options dependant upon the type of goods to be stored.



Chipboard Shelf

Toprax - Longspan Bay Shelving c/w TC Bin Kits

- Fully adjustable bolt free pre-kitted system
- TC container colour options in blue, red, green or yellow
- (Other options available, please contact our Sales Department)
- Overall bay size H1500 x W1812 x D328 mm / Double bay D625mm
- Shelf size W1740 x D290 mm

TC container sizes: (L x W x H)
 TC4: 350 x 205 x 132mm
 TC5: 350 x 205 x 182mm
 TC6: 375 x 420 x 182mm

| Description | Order ref | | | | Price |
|--|---------------|---------------|---------------|---------------|---------|
| | Blue Bins | Red Bins | Green Bins | Yellow Bins | |
| Longspan Bays with Steel Shelves | | | | | |
| Standard Initial Bay c/w 72 x TC4 Bins & 4 shelves | 023370SI/TC4B | 023370SI/TC4R | 023370SI/TC4G | 023370SI/TC4Y | £526.42 |
| Standard Extension Bay c/w 72 x TC4 Bins & 4 shelves | 023370SE/TC4B | 023370SE/TC4R | 023370SE/TC4G | 023370SE/TC4Y | £465.00 |
| Double Initial Bay c/w 144 x TC4 Bins & 8 shelves | 023370DI/TC4B | 023370DI/TC4R | 023370DI/TC4G | 023370DI/TC4Y | £970.00 |
| Double Extension Bay c/w 144 x TC4 Bins & 8 shelves | 023370DE/TC4B | 023370DE/TC4R | 023370DE/TC4G | 023370DE/TC4Y | £895.00 |
| Longspan Bays with Steel Shelves | | | | | |
| Standard Initial Bay c/w 56 x TC5 Bins & 3 shelves | 023370SI/TC5B | 023370SI/TC5R | 023370SI/TC5G | 023370SI/TC5Y | £501.46 |
| Standard Extension Bay c/w 56 x TC5 Bins & 3 shelves | 023370SE/TC5B | 023370SE/TC5R | 023370SE/TC5G | 023370SE/TC5Y | £440.00 |
| Double Initial Bay c/w 112 x TC5 Bins & 6 shelves | 023370DI/TC5B | 023370DI/TC5R | 023370DI/TC5G | 023370DI/TC5Y | £925.00 |
| Double Extension Bay c/w 112 x TC5 Bins & 6 shelves | 023370DE/TC5B | 023370DE/TC5R | 023370DE/TC5G | 023370DE/TC5Y | £850.00 |
| Longspan Bays with Steel Shelves | | | | | |
| Standard Initial Bay c/w 28 x TC6 Bins & 3 shelves | 023370SI/TC6B | 023370SI/TC6R | 023370SI/TC6G | 023370SI/TC6Y | £469.67 |
| Standard Extension Bay c/w 28 x TC6 Bins & 3 shelves | 023370SE/TC6B | 023370SE/TC6R | 023370SE/TC6G | 023370SE/TC6Y | £410.00 |
| Double Initial Bay c/w 56 x TC6 Bins & 6 shelves | 023370DI/TC6B | 023370DI/TC6R | 023370DI/TC6G | 023370DI/TC6Y | £860.00 |
| Double Extension Bay c/w 56 x TC6 Bins & 6 shelves | 023370DE/TC6B | 023370DE/TC6R | 023370DE/TC6G | 023370DE/TC6Y | £790.00 |
| Longspan Bays with Chipboard Shelves | | | | | |
| Standard Initial Bay c/w 72 x TC4 Bins & 4 shelves | 023375SI/TC4B | 023375SI/TC4R | 023375SI/TC4G | 023375SI/TC4Y | £473.74 |
| Standard Extension Bay c/w 72 x TC4 Bins & 4 shelves | 023375SE/TC4B | 023375SE/TC4R | 023375SE/TC4G | 023375SE/TC4Y | £420.00 |
| Double Initial Bay c/w 144 x TC4 Bins & 8 shelves | 023375DI/TC4B | 023375DI/TC4R | 023375DI/TC4G | 023375DI/TC4Y | £885.00 |
| Double Extension Bay c/w 144 x TC4 Bins & 8 shelves | 023375DE/TC4B | 023375DE/TC4R | 023375DE/TC4G | 023375DE/TC4Y | £810.00 |
| Longspan Bays with Chipboard Shelves | | | | | |
| Standard Initial Bay c/w 56 x TC5 Bins & 3 shelves | 023375SI/TC5B | 023375SI/TC5R | 023375SI/TC5G | 023375SI/TC5Y | £461.95 |
| Standard Extension Bay c/w 56 x TC5 Bins & 3 shelves | 023375SE/TC5B | 023375SE/TC5R | 023375SE/TC5G | 023375SE/TC5Y | £410.00 |
| Double Initial Bay c/w 112 x TC5 Bins & 6 shelves | 023375DI/TC5B | 023375DI/TC5R | 023375DI/TC5G | 023375DI/TC5Y | £860.00 |
| Double Extension Bay c/w 112 x TC5 Bins & 6 shelves | 023375DE/TC5B | 023375DE/TC5R | 023375DE/TC5G | 023375DE/TC5Y | £790.00 |
| Longspan Bays with Steel Shelves | | | | | |
| Standard Initial Bay c/w 28 x TC6 Bins & 3 shelves | 023375SI/TC6B | 023375SI/TC6R | 023375SI/TC6G | 023375SI/TC6Y | £430.16 |
| Standard Extension Bay c/w 28 x TC6 Bins & 3 shelves | 023375SE/TC6B | 023375SE/TC6R | 023375SE/TC6G | 023375SE/TC6Y | £380.00 |
| Double Initial Bay c/w 56 x TC6 Bins & 6 shelves | 023375DI/TC6B | 023375DI/TC6R | 023375DI/TC6G | 023375DI/TC6Y | £795.00 |
| Double Extension Bay c/w 56 x TC6 Bins & 6 shelves | 023375DE/TC6B | 023375DE/TC6R | 023375DE/TC6G | 023375DE/TC6Y | £725.00 |

Max capacity per pair of beam levels: 450kg each (UDL)

N.B. Prices include 1 - I.D. label per bin



023370SI/TC6Y

023370SI/TC5B

023370DI/TC5R

Floor fixing is required where shelving bays exceed a height to depth ratio of 4:1

| Toprax Longspan Description | Overall Size H x W x D (mm) | Steel Shelves | | Chipboard Shelves | |
|---|-----------------------------|---------------|---------|-------------------|---------|
| | | Order Ref | Price | Order Ref | Price |
| Standard Initial Bay c/w 3 Levels | 1500 x 1812 x 328 | 023371SI | £275.00 | 023376SI | £240.00 |
| Standard Extension Bay c/w 3 Levels | 1500 x 1780 x 328 | 023371SE | £225.00 | 023376SE | £190.00 |
| Double Initial Bay c/w 6 Levels | 1500 x 1812 x 625 | 023371DI | £485.00 | 023376DI | £420.00 |
| Double Extension Bay c/w 6 Levels | 1500 x 1780 x 625 | 023371DE | £415.00 | 023376DE | £350.00 |
| Standard Initial Bay c/w 3 Levels | 1500 x 1812 x 478 | 023372SI | £285.00 | 023377SI | £235.00 |
| Standard Extension Bay c/w 3 Levels | 1500 x 1780 x 478 | 023372SE | £235.00 | 023377SE | £190.00 |
| Double Initial Bay c/w 6 Levels | 1500 x 1812 x 925 | 023372DI | £535.00 | 023377DI | £435.00 |
| Double Extension Bay c/w 6 Levels | 1500 x 1780 x 925 | 023372DE | £455.00 | 023377DE | £355.00 |
| Longspan Bays with Steel Shelves | | | | | |
| Standard Initial Bay c/w 4 Levels | 2000 x 1812 x 328 | 023373SI | £350.00 | 023378SI | £310.00 |
| Standard Extension Bay c/w 4 Levels | 2000 x 1780 x 328 | 023373SE | £290.00 | 023378SE | £245.00 |
| Double Initial Bay c/w 8 Levels | 2000 x 1812 x 625 | 023373DI | £585.00 | 023378DI | £500.00 |
| Double Extension Bay c/w 8 Levels | 2000 x 1780 x 625 | 023373DE | £540.00 | 023378DE | £455.00 |
| Standard Initial Bay c/w 4 Levels | 2000 x 1812 x 478 | 023374SI | £380.00 | 023379SI | £310.00 |
| Standard Extension Bay c/w 4 Levels | 2000 x 1780 x 478 | 023374SE | £315.00 | 023379SE | £250.00 |
| Double Initial Bay c/w 8 Levels | 2000 x 1812 x 925 | 023374DI | £640.00 | 023379DI | £510.00 |
| Double Extension Bay c/w 8 Levels | 2000 x 1780 x 925 | 023374DE | £595.00 | 023379DE | £460.00 |

Max capacity per pair of beam levels: 450kg each (UDL)

Floor fixing is required where shelving bays exceed a height to depth ratio of 4:1

Quickshelf - Bolt Free Tubular Shelving System

Quickshelf is a robust boltless heavy duty hand loaded shelving system consisting of powder coated blue uprights, galvanised tubular shelves, hardboard covers (if required) and galvanised metal feet.

Its design allows for quick assembly without the need for any special tools as the precision manufactured components are simply knocked into place with a soft faced mallet.

The upright is pierced to offer full adjustability at 25mm pitches in the height.

Quickshelf is suitable for a wide range of applications in the office, workshop, warehouse and home.

Complete bays are supplied with 5 shelves per bay (supplied with/without hardboard covers) and come in initial bays or extension bays. An initial bay is required before any extensions can be added.



920125S/RAP
Initial Bay

920125A/RAP
Extension Bay

Quickshelf - Complete Bays

Initial Bays

| Quickshelf Content Description | H x W x D (mm) | Without Hardboard Covers | | With Hardboard Covers | |
|---------------------------------|-------------------|--------------------------|--------------|-----------------------|--------------|
| | | Order Ref | Price (Each) | Order Ref | Price (Each) |
| Complete with 5 Tubular Shelves | 2000 x 1000 x 400 | 920104S/RAP | £128.70 | 920104SH/RAP | £147.10 |
| Complete with 5 Tubular Shelves | 2000 x 1000 x 500 | 920105S/RAP | £147.88 | 920105SH/RAP | £170.78 |
| Complete with 5 Tubular Shelves | 2000 x 1250 x 400 | 920124S/RAP | £140.32 | 920124SH/RAP | £163.22 |
| Complete with 5 Tubular Shelves | 2000 x 1250 x 500 | 920125S/RAP | £163.11 | 920125SH/RAP | £190.31 |

Extension Bays

| Quickshelf Content Description | H x W x D (mm) | Without Hardboard Covers | | With Hardboard Covers | |
|---------------------------------|-------------------|--------------------------|--------------|-----------------------|--------------|
| | | Order Ref | Price (Each) | Order Ref | Price (Each) |
| Complete with 5 Tubular Shelves | 2000 x 1000 x 400 | 920104A/RAP | £106.08 | 920104AH/RAP | £124.47 |
| Complete with 5 Tubular Shelves | 2000 x 1000 x 500 | 920105A/RAP | £125.26 | 920105AH/RAP | £148.15 |
| Complete with 5 Tubular Shelves | 2000 x 1250 x 400 | 920124A/RAP | £117.70 | 920124AH/RAP | £140.60 |
| Complete with 5 Tubular Shelves | 2000 x 1250 x 500 | 920125A/RAP | £140.48 | 920125AH/RAP | £167.69 |

Shelf Capacity

| | |
|------------------------|---|
| 1000mm x 400mm = 135kg | All shelf capacities are based on a uniformly distributed load. |
| 1000mm x 500mm = 200kg | All shelf capacities are based on a uniformly distributed load. |
| 1250mm x 400mm = 110kg | All shelf capacities are based on a uniformly distributed load. |
| 1250mm x 500mm = 160kg | All shelf capacities are based on a uniformly distributed load. |

Quickshelf - Complete Bays - Plastic Storage/Archive Kits

Initial Bays

| Quickshelf Content Description | H x W x D (mm) | Order Ref | Price (Each) |
|---|-------------------|-----------|--------------|
| 5 x Tubular Shelves & Hardboard Covers, plus 21 x 24L Containers & Lids | 2000 x 1000 x 500 | QAK1 | £286.60 |
| 5 x Tubular Shelves & Hardboard Covers, plus 14 x 35L Containers & Lids | 2000 x 1000 x 500 | QAK3 | £287.90 |
| 5 x Tubular Shelves & Hardboard Covers, plus 21 x 35L Containers & Lids | 2000 x 1250 x 500 | QAK4 | £369.09 |

Extension Bays

| Quickshelf Content Description | H x W x D (mm) | Order Ref | Price (Each) |
|---|-------------------|-----------|--------------|
| 5 x Tubular Shelves & Hardboard Covers, plus 21 x 24L Containers & Lids | 2000 x 1000 x 500 | QAK1E | £263.98 |
| 5 x Tubular Shelves & Hardboard Covers, plus 14 x 35L Containers & Lids | 2000 x 1000 x 500 | QAK3E | £265.25 |
| 5 x Tubular Shelves & Hardboard Covers, plus 21 x 35L Containers & Lids | 2000 x 1250 x 500 | QAK4E | £350.77 |



With hardboard covers

Without hardboard covers

920105SH/RAP

QAK1

See page 30 for Topbox details

Components

| Uprights | | | |
|----------|------------|--------------|--|
| Height | Order Ref | Price (Each) | |
| 2000mm | 900200/RAP | £9.16 | |

| Depth | Standard Shelves | | | | Hardboard Shelf Covers | | | |
|-------|------------------|--------------|--------------|--------------|------------------------|--------------|--------------|--------------|
| | 1000mm Width | | 1250mm Width | | 1000mm Width | | 1250mm Width | |
| | Order Ref | Price (Each) | Order Ref | Price (Each) | Order Ref | Price (Each) | Order Ref | Price (Each) |
| 400mm | 910040T/RAP | £16.53 | 912540T/RAP | £18.84 | 910040HB/D | £3.64 | 912540HB/D | £4.54 |
| 500mm | 910050T/RAP | £20.33 | 912550T/RAP | £23.35 | 910050HB/D | £4.54 | 912550HB/D | £5.39 |

| Accessories | | |
|--------------------------|------------|--------------|
| Description | Order Ref | Price (Each) |
| Plastic Foot for Upright | 900050/RAP | £0.51 |
| Steel Foot Plate - Zinc | 900051/RAP | £2.13 |

Note: 1. A minimum of five shelf levels are required per bay. 2. Floor fixing is required where shelving bays exceed a height to depth ration of 4:1. 3. All dimensions are nominal (please consult our technical department for actual sizes). 4. Other sizes are available - Price on Application.

Quickshelf - Complete Bays - TC Bin Kits

- Fully adjustable
- Bolt free system available pre-kitted
- Ideal for workshops, offices, warehouses and homes
- All components are lightweight

TC container sizes: (L x W x H)

TC4: 350 x 205 x 132mm

TC5: 350 x 205 x 182mm

TC6: 375 x 420 x 182mm

| Product Description | H x W x D (mm) | Order Ref | Price (Each) |
|--|-------------------|---------------|--------------|
| 5 x Tubular Shelves & Hardboard Covers c/w 56 TC4 Blue | 2000 x 1250 x 500 | 920125SH/TC4B | £290.00 |
| 5 x Tubular Shelves & Hardboard Covers c/w 56 TC4 Red | 2000 x 1250 x 500 | 920125SH/TC4R | £290.00 |
| 5 x Tubular Shelves & Hardboard Covers c/w 56 TC4 Green | 2000 x 1250 x 500 | 920125SH/TC4G | £290.00 |
| 5 x Tubular Shelves & Hardboard Covers c/w 56 TC4 Yellow | 2000 x 1250 x 500 | 920125SH/TC4Y | £290.00 |
| 5 x Tubular Shelves & Hardboard Covers c/w 40 TC5 Blue | 2000 x 1250 x 500 | 920125SH/TC5B | £300.00 |
| 5 x Tubular Shelves & Hardboard Covers c/w 40 TC5 Red | 2000 x 1250 x 500 | 920125SH/TC5R | £300.00 |
| 5 x Tubular Shelves & Hardboard Covers c/w 40 TC5 Green | 2000 x 1250 x 500 | 920125SH/TC5G | £300.00 |
| 5 x Tubular Shelves & Hardboard Covers c/w 40 TC5 Yellow | 2000 x 1250 x 500 | 920125SH/TC5Y | £300.00 |
| 5 x Tubular Shelves & Hardboard Covers c/w 20 TC6 Blue | 2000 x 1250 x 500 | 920125SH/TC6B | £280.00 |
| 5 x Tubular Shelves & Hardboard Covers c/w 20 TC6 Red | 2000 x 1250 x 500 | 920125SH/TC6R | £280.00 |
| 5 x Tubular Shelves & Hardboard Covers c/w 20 TC6 Green | 2000 x 1250 x 500 | 920125SH/TC6G | £280.00 |
| 5 x Tubular Shelves & Hardboard Covers c/w 20 TC6 Yellow | 2000 x 1250 x 500 | 920125SH/TC6Y | £280.00 |

N.B. Prices include 1-I.D. label per bin



920125SH/TC5R



920125SH/TC5Y



920125SH/TC4R



920125SH/TC4B



920125SH/TC6Y



920125SH/TC6G

Chrome Shelving

Chrome shelving provides strength within an open wire design that offers unrivalled air and light penetration, making it suitable for various applications.

Many accessories are available to make shelves suitable for garment hanging and wine storage amongst many other applications.

Features:

- **Strong** - each shelf will carry up to 360 kgs (UDL)
- **Durable** - polished nickel chrome finish
- **Bolt free** - quick and easy to assemble
- **Hygienic** - smooth wipe clean surface with open wire design for air flow
- **Versatile** - static or mobile with adjustable shelves
- **Low cost** - quality at affordable cost
- **Adjustable** - all uprights include adjustable foot



Chrome Shelving Complete Kits

| Description | H x W x D (mm) | Order Ref | Price (Per Kit) |
|--|-------------------|-----------|-----------------|
| Complete Chrome Shelving Unit with 4 Shelves | 1625 x 610 x 460 | 020420 | £106.85 |
| Complete Chrome Shelving Unit with 4 Shelves | 1625 x 915 x 460 | 020421 | £133.56 |
| Complete Chrome Shelving Unit with 4 Shelves | 1625 x 1220 x 460 | 020422 | £164.72 |
| Complete Chrome Shelving Unit with 4 Shelves | 1625 x 1520 x 460 | 020423 | £200.34 |
| Complete Chrome Shelving Unit with 4 Shelves | 1625 x 610 x 610 | 020424 | £133.56 |
| Complete Chrome Shelving Unit with 4 Shelves | 1625 x 915 x 610 | 020425 | £169.18 |
| Complete Chrome Shelving Unit with 4 Shelves | 1625 x 1220 x 610 | 020426 | £209.24 |
| Complete Chrome Shelving Unit with 4 Shelves | 1625 x 1520 x 610 | 020427 | £249.31 |

Chrome Basket Trolley Complete Kit

- Baskets can be easily adjusted along uprights
- Protective bumpers supplied
- 90mm lip on baskets
- 120mm rubber cushion castors, 2 supplied as braked

| Description | H x W x D (mm) | Capacity (kg) | Order Ref | Price (Per Kit) |
|-----------------------|------------------|---------------|-----------|-----------------|
| Chrome Basket Trolley | 1005 x 915 x 460 | 150 | TCT1 | £185.50 |

Components

| Description | Order Ref | Price |
|---|-----------|--------------------|
| Chrome Shelving Upright - L 760mm, Complete with adjustable foot | 020350 | £5.57 (Each) |
| Chrome Shelving Upright - L 1625mm, Complete with adjustable foot | 020355 | £10.02 (Each) |
| Chrome Shelving Upright - L 1830mm, Complete with adjustable foot | 020358 | £11.13 (Each) |
| Chrome Shelving Upright - L 2130mm, Complete with adjustable foot | 020359 | £13.36 (Each) |
| Chrome Shelf (Pack of 4) - W 610 x D 460mm | 020369 | £66.80 (Per Pack) |
| Chrome Shelf (Pack of 4) - W 915 x D 460mm | 020375 | £93.49 (Per Pack) |
| Chrome Shelf (Pack of 4) - W 1220 x D 460mm | 020379 | £124.66 (Per Pack) |
| Chrome Shelf (Pack of 4) - W 1520 x D 460mm | 020383 | £160.28 (Per Pack) |
| Chrome Shelf (Pack of 4) - W 610 x D 610mm | 020385 | £93.48 (Per Pack) |
| Chrome Shelf (Pack of 4) - W 915 x D 610mm | 020389 | £129.11 (Per Pack) |
| Chrome Shelf (Pack of 4) - W 1220 x D 610mm | 020393 | £169.18 (Per Pack) |
| Chrome Shelf (Pack of 4) - W 1520 x D 610mm | 020397 | £209.24 (Per Pack) |



Accessories

| Description | Order Ref | Price |
|--|-----------|-------------------|
| Chrome Shelf Ledges (Pack of 2) - H 100 x L 460mm | 020400 | £4.90 (Per Pack) |
| Chrome Shelf Ledges (Pack of 2) - H 100 x L 610mm | 020401 | £5.79 (Per Pack) |
| Chrome Shelf Ledges (Pack of 2) - H 100 x L 915mm | 020402 | £7.57 (Per Pack) |
| Chrome Shelf Ledges (Pack of 2) - H 100 x L 1220mm | 020403 | £9.79 (Per Pack) |
| Chrome Shelf Ledges (Pack of 2) - H 100 x L 1520mm | 020404 | £12.02 (Per Pack) |
| Chrome Shelf Dividers (Pack of 2) - H 220 x L 460mm | 020405 | £11.13 (Per Pack) |
| Chrome Shelf Dividers (Pack of 2) - H 220 x L 610mm | 020406 | £13.36 (Per Pack) |
| Chrome Shelf Add on Clip (Each) | 020407 | £1.34 (Each) |
| Chrome Shelving Plastic Shelf Collar Set (2 Pcs per Set) | 020408 | £2.23 (Per Set) |
| Rubber Wheeled Castor - Unbraked - Dia 100mm - Capacity 80kg (For overall height add 140mm to the post height) | 020432 | £11.13 (Each) |
| Rubber Wheeled Castor - Braked - Dia 100mm - Capacity 80kg (For overall height add 140mm to the post height) | 020433 | £13.36 (Each) |
| Short Cart Handle - L 460mm | 020447 | £7.57 (Each) |
| Short Cart Handle - L 610mm | 020448 | £8.90 (Each) |
| Basket (95mm deep) - W 460 x L 610mm | 020450 | £28.94 (Each) |
| Basket (95mm deep) - W 460 x L 915mm | 020451 | £35.62 (Each) |
| Back Grid - W 915 x H 350mm | 020454 | £11.13 (Each) |
| Back Grid - W 1220 x H 350mm | 020455 | £13.36 (Each) |
| Garment Rail - L 915mm, Complete with 2 support hooks | 020435 | £5.57 (Each) |
| Garment Rail - L 1220mm, Complete with 2 support hooks | 020436 | £7.79 (Each) |
| Garment Rail - L 1520mm, Complete with 2 support hooks | 020437 | £8.90 (Each) |
| Utility Rail - L 460mm | 020438 | £3.78 (Each) |
| Utility Rail - L 640mm | 020439 | £4.45 (Each) |
| Utility Rail - L 915mm | 020440 | £5.57 (Each) |
| Utility Rail - L 1220mm | 020441 | £7.12 (Each) |
| Utility Rail - L 1520mm | 020442 | £8.01 (Each) |

Bartspan - Longspan Shelving

Bartspan is perfectly designed to meet all types of requirements for storing medium weight products of different sizes. Upright connections are provided with two hooks and a locking pin. It is a very simple system to assemble.

This shelving is a cost effective way to increase storage capacity and make more economical use of valuable floor space, even existing warehouses.

A wide range of frames, beams and components makes Bartspan a highly versatile system suitable for storing every type of product, from small components to heavy cartons.

The frames are epoxy powder coated blue uprights with galvanised bracing and the beams are grey as standard, however, other colours are available.

The frames are a fully bolted construction. Consisting of uprights, coldformed cross ties and diagonal bracing.



Bartspan - Complete Initial Bays

| Description | H x W x D (mm) | Shelf Capacity (Kg) | Order Ref | Price (Each) |
|--|-------------------|---------------------|-----------|--------------|
| 3 x Chipboard Shelves | 2100 x 1800 x 600 | 586 | 3211806S | £406.92 |
| 3 x Chipboard Shelves | 2100 x 2400 x 600 | 396 | 3212406S | £480.31 |
| Additional Shelf Level - 2 x beams and 1 x chipboard shelf | 1800W x 600D | 586 | 318007S | £91.44 |
| Additional Shelf Level - 2 x beams and 1 x chipboard shelf | 2400W x 600D | 396 | 324007S | £115.90 |

Bartspan - Complete Extension Bays

| Description | H x W x D (mm) | Shelf Capacity (Kg) | Order Ref | Price (Each) |
|--|-------------------|---------------------|-----------|--------------|
| 3 x Chipboard Shelves | 2100 x 1800 x 600 | 586 | 3211806A | £340.62 |
| 3 x Chipboard Shelves | 2100 x 2400 x 600 | 396 | 3212406A | £414.01 |
| Additional Shelf Level - 2 x beams and 1 x chipboard shelf | 1800W x 600D | 586 | 318007S | £91.44 |
| Additional Shelf Level - 2 x beams and 1 x chipboard shelf | 2400W x 600D | 396 | 324007S | £115.90 |



3211806S
Initial Bay

3211806A
Extension Bay

Bartspan - Longspan Shelving

Bartspan - Frames

| H x D (mm) | Order Ref | Price (Each) |
|------------|-----------|--------------|
| 1800 x 600 | 361806/D | £61.92 |
| 1800 x 700 | 361807/D | £63.02 |
| 1800 x 800 | 361808/D | £64.15 |
| 1800 x 900 | 361809/D | £65.29 |
| 2100 x 600 | 362160/D | £66.31 |
| 2100 x 700 | 362170/D | £59.97 |
| 2100 x 800 | 362180/D | £61.02 |
| 2100 x 900 | 362190/D | £62.12 |
| 2400 x 600 | 362406/D | £67.52 |
| 2400 x 700 | 362407/D | £68.77 |
| 2400 x 800 | 362408/D | £70.10 |
| 2400 x 900 | 362409/D | £71.43 |



Bartspan - Beams

| Length (mm) | 60 Step Beam | | | 70 Step Beam | | |
|-------------|------------------------|--------------|--------------|------------------------|--------------|--------------|
| | Capacity (Per Pair) Kg | Order Ref | Price (Each) | Capacity (Per Pair) Kg | Order Ref | Price (Each) |
| 1500 | 520 | 316315S/60/D | £23.52 | - | - | - |
| 1800 | 433 | 316318S/60/D | £26.89 | 586 | 316318S/70/D | £32.49 |
| 2100 | 336 | 316321S/60/D | £30.22 | 502 | 316321S/70/D | £33.19 |
| 2400 | - | - | - | 396 | 316324S/70/D | £39.85 |



Bartspan - Chipboard Decks

| W x D (mm) | Order Ref | Price (Each) |
|------------|-----------|--------------|
| 1500 x 600 | 321560S/D | £19.85 |
| 1500 x 700 | 321570S/D | £29.55 |
| 1500 x 800 | 321580S/D | £35.74 |
| 1500 x 900 | 321590S/D | £36.01 |
| 1800 x 600 | 321860S/D | £26.46 |
| 1800 x 700 | 321870S/D | £30.77 |
| 1800 x 800 | 321880S/D | £36.99 |
| 1800 x 900 | 321890S/D | £37.74 |
| 2100 x 600 | 322160S/D | £27.79 |
| 2100 x 700 | 322170S/D | £57.38 |
| 2100 x 800 | 322180S/D | £37.07 |
| 2100 x 900 | 322190S/D | £58.24 |
| 2400 x 600 | 322460S/D | £36.21 |
| 2400 x 700 | 322470S/D | £44.03 |
| 2400 x 800 | 322480S/D | £48.34 |
| 2400 x 900 | 322490S/D | £52.65 |

System Requirements:

- Each bay must have a minimum of 2 shelves.
- End frames capacity = 4300Kg based upon 3 levels at 700mm centres.
- End frames include all components that are required apart from floor fixings.
- Where bays exceed a height to depth ratio of 4:1 floor fixing required.
- All loading data is based on uniformly distributed loads.



Adjustable Cantilever Racking

- A sturdy racking system designed to accommodate long goods, pipes and bars etc.
- Robust arms securely hold the load, with end stops to prevent roll off.
- Available in various size options with add on bays to suit most long parts storage.
- Designed to be hand loaded.
- Load capacity per arm: up to 200kg (UDL).
- Arms height adjustable at 50mm increments with two fixing bolts.
- Colours: Uprights - Galvanised
Arms - Yellow

Starter Frame Kit consists of

- 2 x Complete frames - 2100mm
- 2 x Beams - L1300mm
- 2 x Bases
- Bracing

Extension Frame Kit consists of

- 1 x Complete frame - 2100mm
- 3 x Beams - L1300mm
- 1 x Base
- Bracing

How to order:

- Choose a single or double sided starter frame kit.
- Choose the number of extension frames required.
- Choose the number of arms separately.
- Choose the number of intermediate dividers and removable end stops separately.

Single Sided Starter Bay Double Sided Starter Bay



211340DS/E
8 x (310164100), 2 x (310164801) and 10 x (310164704)
Double Sided Extension Frame with 8 x 400mm Arms,
2 x Intermediate Dividers and 10 x Removable End Stops.

211340DS/S
16 x (310164100), 4 x (310164801) and 20 x (310164704)
Double Sided Starter Frame Kit with 16 x 400mm Arms,
4 x Intermediate Dividers and 20 x Removable End Stops.

Single Sided Frame Kits Without Arms

| Description For Arm Lengths | H x W x D(mm) | Starter Bay Kit | | Extension Bay Kit | |
|-----------------------------|--------------------|-----------------|-----------------|-------------------|-----------------|
| | | Order Ref | Price (Per Kit) | Order Ref | Price (Per Kit) |
| 400mm | 2100 x 1350 x 810 | 211340SS/S | £329.37 | 211340SS/E | £186.66 |
| 500mm | 2100 x 1350 x 910 | 211350SS/S | £329.37 | 211350SS/E | £186.66 |
| 600mm | 2100 x 1350 x 1010 | 211360SS/S | £342.95 | 211360SS/E | £193.45 |
| 800mm | 2100 x 1350 x 1210 | 211380SS/S | £342.95 | 211380SS/E | £235.70 |

Double Sided Frame Kits Without Arms

| Description For Arm Lengths | H x W x D(mm) | Starter Bay Kit | | Extension Bay Kit | |
|-----------------------------|--------------------|-----------------|-----------------|-------------------|-----------------|
| | | Order Ref | Price (Per Kit) | Order Ref | Price (Per Kit) |
| 400mm | 2100 x 1350 x 1200 | 211340DS/S | £372.74 | 211340DS/E | £208.35 |
| 500mm | 2100 x 1350 x 1400 | 211350DS/S | £399.16 | 211350DS/E | £221.56 |
| 600mm | 2100 x 1350 x 1600 | 211360DS/S | £427.45 | 211360DS/E | £235.70 |
| 800mm | 2100 x 1350 x 2000 | 211380DS/S | £427.45 | 211380DS/E | £235.70 |

Arms

| Length (mm) | Capacity (Kgs) | Order Ref | Price (Each) |
|-------------|----------------|-----------|--------------|
| 400 | 200 | 310164100 | £32.35 |
| 500 | 160 | 310164208 | £35.88 |
| 600 | 130 | 310164305 | £40.30 |
| 800 | 100 | 310164607 | £45.70 |

Accessories

| Description | Order Ref | Price (Each) |
|-----------------------|-----------|--------------|
| Intermediate Dividers | 310164801 | £9.49 |
| Removable End Stops | 310164704 | £3.74 |

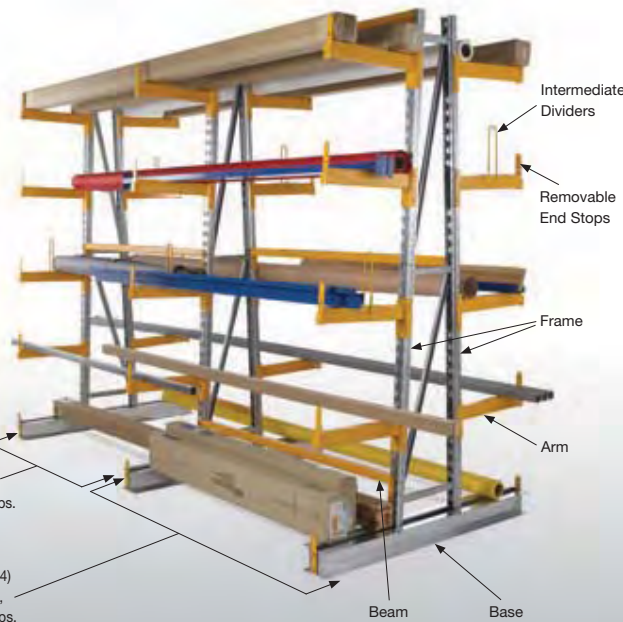

Bartrak - Adjustable Pallet Racking

Bartrak is a strong and thoroughly proven pallet racking system. Frames are of bolted construction to allow easy component replacement, if damaged.

The pallet racking is simple to adjust or extend and suitable for all types of pallet loads. A wide range of frames and beams are available as standard, with frames finished epoxy powder coated blue, and beams in high visibility orange.

The uprights are adjustable at 75mm centres to allow greater flexibility when positioning beams.

The beams are available in rationalised series of lengths from 1800 to 3900mm. Beams are cold formed from two 'C' sections nested together and welded to upright connectors.



System Components

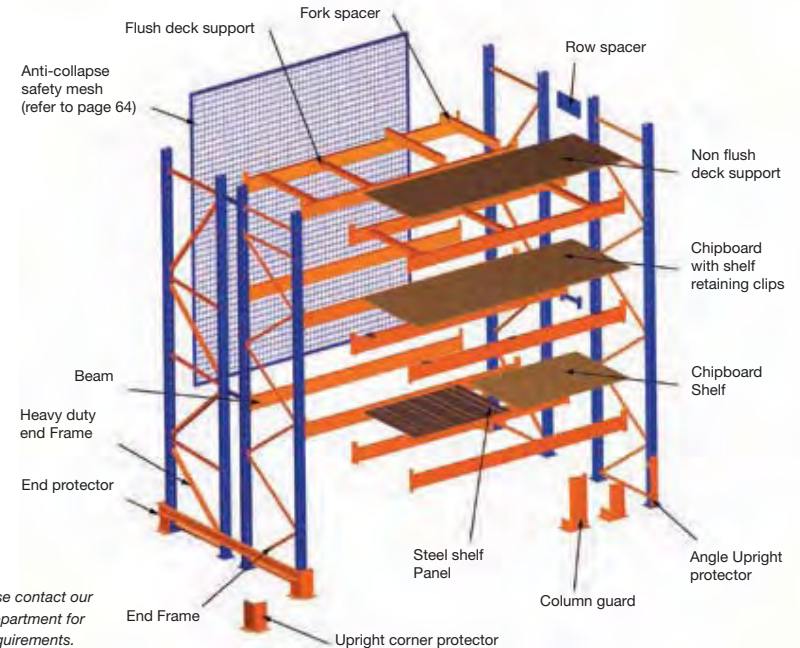

Note: Please contact our projects department for specific requirements.

Topmesh - Anti Collapse

Anti Collapse is a safety mesh system that provides a tough, durable and secure mesh screen on the rear of adjustable pallet racking installations.

Its versatility enables it to be fitted to practically any make of pallet racking.

The system prevents loosely stacked palletised goods from falling, and in doing so protects both personnel from injury and damage to valuable stock.

The product provides a strong, secure system when the panels are fixed in their standard "brickwork" formation.

A range of panel sizes are available to accommodate a variety of racking heights. This allows any installation to be easily extended or repositioned at a later date. The panels can be cut on site, to fit around obstacles and/or projections, with replacement framework available to refurbish cut panel edges.

Features:

- An easy to install safety system.
- Prevent loosely stacked palletised goods from falling.
- Protect personnel from injury and valuable stock from damage.
- Provide a strong security system when panels are fixed in 'brickwork' formation.
- Systems can be extended or repositioned.
- 20 panel sizes to accommodate a variety of racking heights.
- Panels can be cut, on site, to fit around obstacles and projections. Replacement framework available to refurbish cut edges.



Mesh Panel Specification

Mesh Spacing : 18 x 97mm
 Uprights : 30 x 25mm
 Horizontals : Ø19mm
 Wires : Ø2.5mm and Ø3.0mm
 Finish : Galvanised

Note: Please contact our projects department for specific requirements.

LOCKERS / CLOAKROOM EQUIPMENT / CABINETS

Lockers and cloakroom equipment to suit all requirements. Plus a range of safety, hazardous and fire resistant cabinets

| Product | Lead Time (Working Days) | Page |
|--|-----------------------------|------|
| Standard Lockers | (10-20) | 66 |
| Retail High Density Lockers | (10-20) | 68 |
| Clean Environment & Space Saving Lockers. | (10-20) | 69 |
| Cube & Quarto Lockers | (10-20) | 70 |
| Cloakroom Equipment. | (10-20) | 70 |
| Wire Mesh Lockers | (10-15) | 72 |
| Securistore - High Security Cabinets | (7-10) | 73 |
| Safestore - Hazardous Substance Cabinets | (7-10) | 74 |
| Safestore - Acid Substance Cabinets | (7-10) | 75 |
| Safestore - COSHH Substance Cabinets | (7-10) | 75 |
| Safestore - Pesticide Substance Cabinets | (7-10) | 76 |
| Safestore - Flame-Safe Storage Bin | (7-10) | 76 |
| Safestore - General Cabinet | (7-10) | 76 |

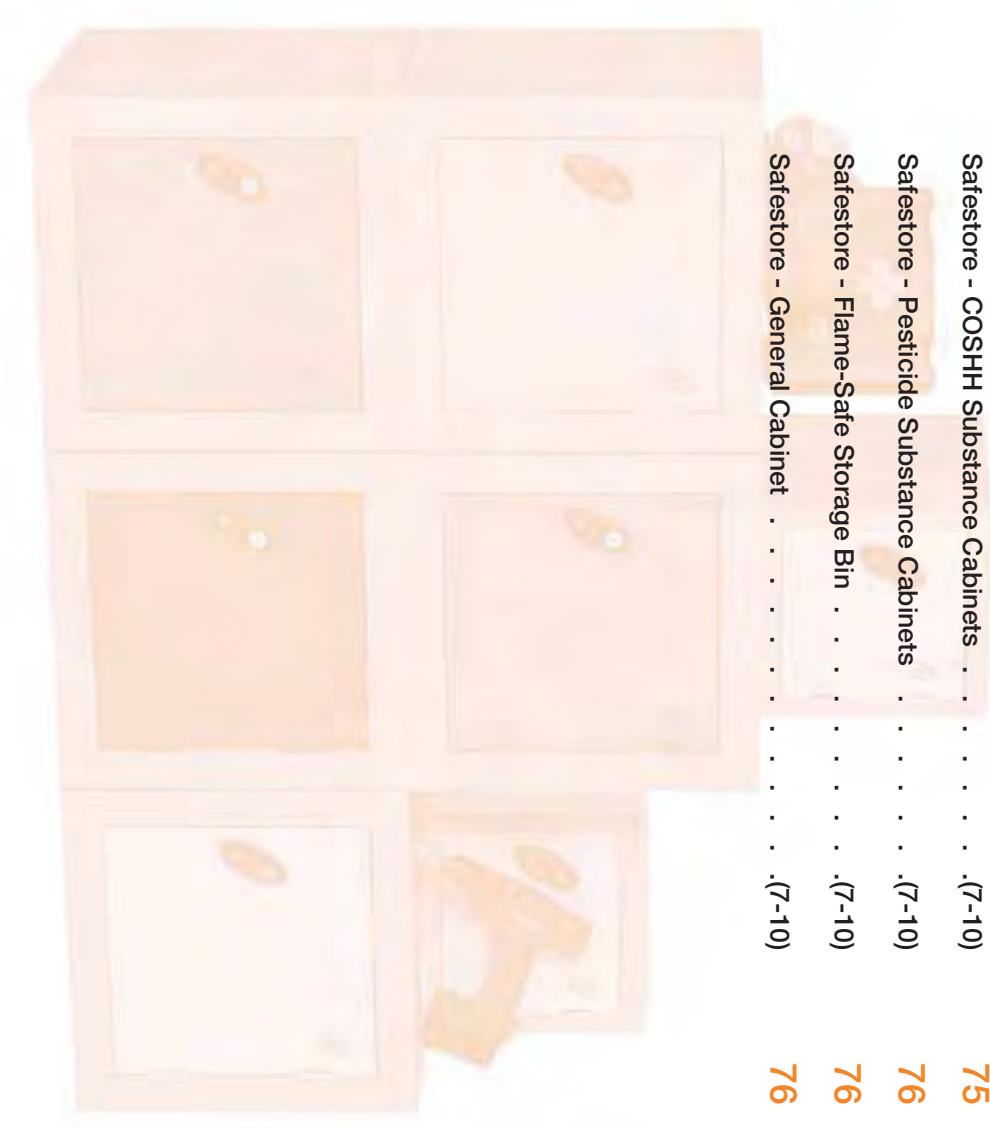

Standard Lockers

The choice is yours, from 1 to 8 doors.

Quality engineered to provide a sturdy and robust unit that will give the user many years of uninterrupted services.

Built-in security features generate confidence that belongings will be kept safe. Attention to detail guarantees ease of use and provides for the rapid replacement of locks and keys.

Durable powder coated finish with colour options for every environment.

Carcass Colour Options



Door Colour Options

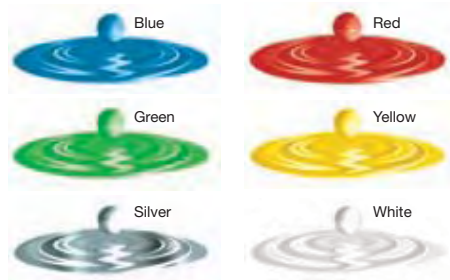

Single Tier Lockers includes a topshelf and double coat hook.

Two Tier Lockers includes a double coat hook in each compartment.

Note:

When ordering please specify full requirements to include;

1. Order Ref.
2. Single or Nested Unit.
3. Carcass colour option.
4. Door colour option.

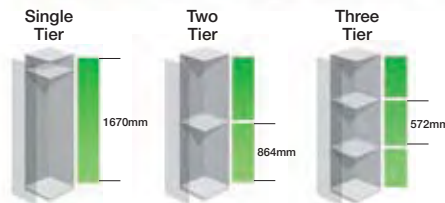

| Description | H x W x D (mm) | Order Ref | Price (Single) | Price (Nest of 2) | Price (Nest of 3) |
|--------------------|------------------|-----------|----------------|-------------------|-------------------|
| Single Tier Locker | 1780 x 305 x 305 | 701212 | £88.90 | £167.34 | £245.79 |
| Single Tier Locker | 1780 x 305 x 380 | 701215 | £95.40 | £178.16 | £260.92 |
| Single Tier Locker | 1780 x 305 x 460 | 701218 | £106.25 | £196.38 | £286.51 |
| Single Tier Locker | 1780 x 380 x 380 | 701515 | £106.25 | £196.38 | £308.54 |
| Single Tier Locker | 1780 x 460 x 460 | 701818 | £126.13 | £236.15 | N/A |
| <hr/> | | | | | |
| Two Tier Lockers | 1780 x 305 x 305 | 701212/2 | £116.29 | £222.13 | £327.98 |
| Two Tier Lockers | 1780 x 305 x 380 | 701215/2 | £120.90 | £229.16 | £337.41 |
| Two Tier Lockers | 1780 x 305 x 460 | 701218/2 | £129.77 | £243.42 | £357.07 |
| Two Tier Lockers | 1780 x 380 x 380 | 701515/2 | £129.77 | £243.42 | £357.07 |
| Two Tier Lockers | 1780 x 460 x 460 | 701818/2 | £152.64 | £289.15 | N/A |
| <hr/> | | | | | |
| Three Tier Lockers | 1780 x 305 x 305 | 701212/3 | £126.16 | £241.87 | £357.58 |
| Three Tier Lockers | 1780 x 305 x 380 | 701215/3 | £132.84 | £253.04 | £373.24 |
| Three Tier Lockers | 1780 x 305 x 460 | 701218/3 | £141.44 | £266.76 | £392.08 |
| Three Tier Lockers | 1780 x 460 x 460 | 701818/3 | £162.18 | £308.24 | N/A |

Lock and Door Options

All lockers are supplied as standard with Cam Locks. Other locking options are available. (Please contact our Sales Department).

All lockers are supplied as standard with Standard Fit Doors. Other door options are available. (Please contact our Sales Department).

Lock Options



Standard Cam Lock
Micro sprung 10 disc lock with 3000 serial combination.

Hasp and Staple
Design allows easy use of padlock fitting. Shank diameter minimum 7mm, maximum 8mm. Padlock is not supplied.

Coin/Token Return/Retain
Available with a number of coin denominations or token styles, for either return or retain.

Radial Pin Tumbler Lock
Gives a greater level of security where special applications demand.

Three Point Lever Bolt Locking
Provides extra security for 1/2 door options by securing 3 door edges to locker frame. May be used with Standard Cam, Hasp and Staple or Radial Pin locks

Door Options



Standard Fit Door
Incorporates either 1 or 2 unique oval vents. (2 vents on 1/2/3 doors, others have 1 vent).

Perforated Door
Incorporates either Allows ventilation and limited visibility.

Clear Polycarbonate Door
Provides full visual access within locker compartments. (Available only for single to six tier lockers).

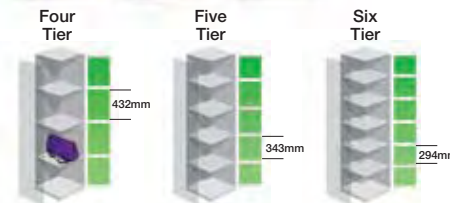

| Description | H x W x D (mm) | Order Ref | Price (Single) | Price (Nest of 2) | Price (Nest of 3) |
|--------------------|------------------|-----------|----------------|-------------------|-------------------|
| Four Tier Lockers | 1780 x 305 x 305 | 701212/4 | £134.89 | £259.33 | £383.77 |
| Four Tier Lockers | 1780 x 305 x 380 | 701215/4 | £145.36 | £278.07 | £410.77 |
| Four Tier Lockers | 1780 x 305 x 460 | 701218/4 | £151.54 | £286.96 | £422.38 |
| Four Tier Lockers | 1780 x 380 x 380 | 701515/4 | £151.54 | £286.96 | £422.38 |
| Four Tier Lockers | 1780 x 460 x 460 | 701818/4 | £176.36 | £336.60 | N/A |
| <hr/> | | | | | |
| Five Tier Lockers | 1780 x 305 x 305 | 701212/5 | £144.43 | £278.42 | £412.40 |
| Five Tier Lockers | 1780 x 305 x 380 | 701215/5 | £150.17 | £287.69 | £425.21 |
| Five Tier Lockers | 1780 x 305 x 460 | 701218/5 | £158.46 | £300.81 | £443.16 |
| <hr/> | | | | | |
| Six Tier Lockers | 1780 x 305 x 305 | 701212/6 | £166.33 | £322.20 | £478.08 |
| Six Tier Lockers | 1780 x 305 x 380 | 701215/6 | £168.82 | £324.99 | £481.17 |
| Six Tier Lockers | 1780 x 305 x 460 | 701218/6 | £181.14 | £346.17 | £511.19 |
| Six Tier Lockers | 1780 x 380 x 380 | 701515/6 | £181.14 | £346.17 | £511.19 |
| <hr/> | | | | | |
| Eight Tier Lockers | 1780 x 305 x 460 | 701218/8 | £245.02 | N/A | N/A |

Retail High Density Lockers

General Specification

All components are manufactured from 0.7mm mild steel with the exception of the doors and frame which are 0.9mm.

Door colours available are Red, Cream, Blue, Yellow, Green and White. Carcass colour options are Silver Grey, White and Coffee (we reserve the right to alter specifications).

Garment Collector

This "post box" style locker is for the collective storage of soiled garments. An inner anti-theft plate prevents items being removed once they have been "posted".

Garment Dispenser

A single service door provides access to all the inner compartments of these Garment Dispensers enabling the distribution of clean garments, towels etc. Individual compartments remain secure and require keyed access.

Post Box Lockers

These lockers are ideal for the post box system, offering security and ease of access for the recipient.

16 Door High Density

Ideally suited for secure storage of small items.



Garment Collector 10 Door Garment Dispenser 15 Door Garment Dispenser Post Box Lockers Eight Tier Lockers 16 Door High Density

| Description | H x W x D (mm) | Order Ref | Price (Single) | Price (Nest of 2) | Price (Nest of 3) |
|---------------------------|------------------|------------|----------------|-------------------|-------------------|
| Garment Collector | 1780 x 380 x 460 | BULK | £200.78 | N/A | N/A |
| 5 Door Garment Dispenser | 1780 x 380 x 460 | GD5 | £238.70 | N/A | N/A |
| 10 Door Garment Dispenser | 1780 x 380 x 460 | GD10 | £299.24 | N/A | N/A |
| 15 Door Garment Dispenser | 1780 x 380 x 460 | GD15 | £360.20 | N/A | N/A |
| Post Lockers Six Tier | 1780 x 305 x 405 | 701212/PL6 | £207.90 | £405.35 | £602.80 |
| Post Lockers Six Tier | 1780 x 305 x 460 | 701218/PL6 | £226.42 | £436.72 | £647.02 |
| Eight Tier Lockers | 1780 x 305 x 460 | 701218/8 | £245.02 | N/A | N/A |
| 16 Door High Density | 1780 x 305 x 460 | 701218/16 | £399.89 | N/A | N/A |

Note: These lockers are not available with coin retain, coin return or combination locks.

Clean Environment & Space Saving Lockers

Keeping clean garments and soiled work overalls separate can often be a problem. The Clean and Dirty Locker solves this problem by providing a centre partition with a double coat hook to either side.

Identical in overall size the Uniforms Locker has three handy shelves to one side of the partition and includes a double coat hooked on the other side.

The Two Person and Twin Lockers include two double coat hooks.

Where space really is at a premium then these versatile locker units must be the answer. Each offers two users full depth for garments on hooks while keeping the unit overall width to a minimum.

Door colours available are Red, Cream, Blue, Yellow, Green and White. Carcass colour options are Silver Grey, White and Coffee.

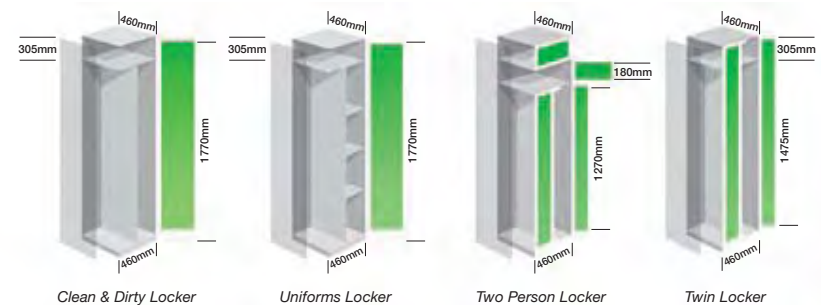

Clean & Dirty Locker Uniforms Locker Two Person Locker Twin Locker



Clean & Dirty Locker Uniforms Locker Two Person Locker Twin Locker

| Description | H x W x D (mm) | Order Ref | Price (Single) | Price (Nest of 2) |
|----------------------|------------------|------------|----------------|-------------------|
| Clean & Dirty Locker | 1780 x 460 x 460 | 701818 C/D | £150.98 | £285.85 |
| Uniforms Locker | 1780 x 460 x 460 | 701818 UN | £170.24 | £324.37 |
| Two Person Locker | 1780 x 460 x 460 | 2P701818 | £188.48 | £360.84 |
| Twin Locker | 1780 x 460 x 460 | TW701818 | £175.46 | £345.68 |

Note: The Two Person Locker is not available with coin retain, coin return or combination locks. All other lockers are available with the lock options as shown on page 69.

Cube & Quarto Lockers

The handy Cube lockers can be used as multi-purpose storage units. Offered in three standard sizes, they are supplied pre-drilled for bolting together in blocks as needed.

Quartos have been designed for use individually, bolted together in blocks, or to complement other locker combinations by acting as linking bridges or additional top lockers.



| CUBE LOCKERS | | |
|-----------------|-----------|--------------|
| H x W x D (mm) | Order Ref | Price (Each) |
| 305 x 305 x 305 | 121212 | £47.82 |
| 380 x 380 x 380 | 151515 | £56.19 |
| 460 x 460 x 460 | 181818 | £62.29 |

| QUARTO LOCKERS | | |
|-----------------|-----------|--------------|
| H x W x D (mm) | Order Ref | Price (Each) |
| 480 x 305 x 305 | 191212 | £52.09 |
| 480 x 305 x 460 | 191218 | £59.69 |

Cloakroom Equipment

Shoe Baskets

- Strong wire mesh baskets black plastic coated
- To suit cloakroom units & benches 1525mm long
- L x H x D: 1200 x 320 x 270mm (SB1 & SB10)
- L x H x D: 1200 x 170 x 270mm (SB5)



Fixings are not included.

| SHOE BASKETS | | |
|-----------------|-----------|--------------|
| No. of Sections | Order Ref | Price (Each) |
| 1 | SB1 | £124.58 |
| 5 | SB5 | £134.82 |
| 10 | SB10 | £146.87 |

Sapele Coat Rails

- Supplied with aluminium coat hooks



Wall fixings are not included.

| COAT RAILS (70 x 20mm Sapele) | | | | |
|-------------------------------|--------|-----------|--------------|--|
| No. of Hooks | Length | Order Ref | Price (Each) | |
| 6 | 915mm | CR6 | £67.41 | |
| 9 | 1220mm | CR9 | £71.35 | |
| 12 | 1525mm | CR12 | £77.02 | |

Cloakroom Equipment

Cloakroom Units

- Strong and Sturdy - Manufactured from Epoxy powder coated 38 x 38mm RHS steel frame
- Seat slats are supplied flat packed for easy assembly
- Top & seat slats are 70 x 32mm sapele timber, with 4 radiused corners and have been sanded, sealed and polished with a tough water based lacquer.



DS24

Complete with Hooks (1730mm high)



DS20H

Complete with Hangers (1800mm high)

Floor fixings are not included.

Complete with Aluminium Hooks (1730mm high)

| Length (mm) | Single Sided | | | Double Sided | | |
|-------------|--------------|-----------|--------------|--------------|-----------|--------------|
| | No. of Hooks | Order Ref | Price (Each) | No. of Hooks | Order Ref | Price (Each) |
| 915 | 6 | SS6 | £304.29 | 12 | DS12 | £396.35 |
| 1220 | 9 | SS9 | £341.07 | 18 | DS18 | £457.54 |
| 1525 | 12 | SS12 | £378.00 | 24 | DS24 | £506.68 |

Complete with Yellow Plastic Hangers (1800mm high)

| Length (mm) | Single Sided | | | Double Sided | | |
|-------------|----------------|-----------|--------------|----------------|-----------|--------------|
| | No. of Hangers | Order Ref | Price (Each) | No. of Hangers | Order Ref | Price (Each) |
| 915 | 6 | SS6H | £363.62 | 12 | DS12H | £529.04 |
| 1220 | 8 | SS8H | £400.34 | 16 | DS16H | £606.69 |
| 1525 | 10 | SS10H | £455.57 | 20 | DS20H | £696.70 |

Bench Seats

- Strong and Sturdy
- Frame & Seat slats as Cloakroom Units above

Floor fixings are not included.

| BENCH SEATS (H 400 x D 300mm) | | |
|-------------------------------|-----------|--------------|
| Length | Order Ref | Price (Each) |
| 915mm | B36 | £161.44 |
| 1220mm | B48 | £171.68 |
| 1525mm | B60 | £183.80 |



Wire Mesh Lockers

Wire mesh lockers are becoming very popular within the storage industry. Manufactured from wire mesh they allow maximum visibility and ventilation whilst maintaining security.

All lockers are manufactured from 8mm and 6mm round bar. Mesh is 25 x 25 x 2.5mm. All lockers are fitted with hasp and staple for locking doors using a padlock (not supplied). Lockers can be manufactured to any size or dimension, they will bolt to the floor, side by side, back to back or to a wall. All lockers are finished in bright zinc.



Note: Padlocks are not supplied

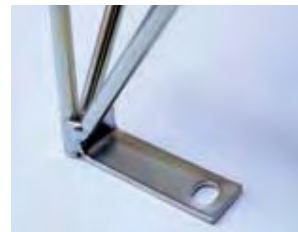

| Description | H x W x D (mm) | Single Compartment c/w Doors | | 2 Compartments c/w Doors | | 3 Compartments c/w Doors | |
|-------------|------------------|------------------------------|--------------|--------------------------|--------------|--------------------------|--------------|
| | | Order Ref | Price (Each) | Order Ref | Price (Each) | Order Ref | Price (Each) |
| Single | 1980 x 305 x 305 | ML305/1/1 | £164.09 | ML305/2/1 | £171.24 | ML305/3/1 | £181.96 |
| Nest of 2 | 1980 x 610 x 305 | ML305/1/2 | £288.69 | ML305/2/2 | £306.88 | ML305/3/2 | £318.12 |
| Nest of 3 | 1980 x 915 x 305 | ML305/1/3 | £421.32 | ML305/2/3 | £448.73 | ML305/3/3 | £475.22 |
| Single | 1980 x 305 x 381 | ML381/1/1 | £171.18 | ML381/2/1 | £178.71 | ML381/3/1 | £189.96 |
| Nest of 2 | 1980 x 610 x 381 | ML381/1/2 | £303.14 | ML381/2/2 | £322.23 | ML381/3/2 | £334.03 |
| Nest of 3 | 1980 x 915 x 381 | ML381/1/3 | £442.40 | ML381/2/3 | £471.17 | ML381/3/3 | £498.98 |
| Single | 1980 x 305 x 457 | ML450/1/1 | £178.27 | ML450/2/1 | £191.00 | ML450/3/1 | £202.27 |
| Nest of 2 | 1980 x 610 x 457 | ML450/1/2 | £317.46 | ML450/2/2 | £343.37 | ML450/3/2 | £367.62 |
| Nest of 3 | 1980 x 915 x 457 | ML450/1/3 | £463.32 | ML450/2/3 | £501.67 | ML450/3/3 | £538.34 |

| Description | H x W x D (mm) | 4 Compartments c/w Doors | | 5 Compartments c/w Doors | | 6 Compartments c/w Doors | |
|-------------|------------------|--------------------------|--------------|--------------------------|--------------|--------------------------|--------------|
| | | Order Ref | Price (Each) | Order Ref | Price (Each) | Order Ref | Price (Each) |
| Single | 1980 x 305 x 305 | ML305/4/1 | £192.62 | ML305/5/1 | £207.09 | ML305/6/1 | £221.53 |
| Nest of 2 | 1980 x 610 x 305 | ML305/4/2 | £351.76 | ML305/5/2 | £383.61 | ML305/6/2 | £415.46 |
| Nest of 3 | 1980 x 915 x 305 | ML305/4/3 | £501.70 | ML305/5/3 | £556.60 | ML305/6/3 | £611.50 |
| Single | 1980 x 305 x 381 | ML381/4/1 | £201.16 | ML381/5/1 | £216.33 | ML381/6/1 | £231.51 |
| Nest of 2 | 1980 x 610 x 381 | ML381/4/2 | £369.36 | ML381/5/2 | £402.80 | ML381/6/2 | £436.24 |
| Nest of 3 | 1980 x 915 x 381 | ML381/4/3 | £526.78 | ML381/5/3 | £584.44 | ML381/6/3 | £642.08 |
| Single | 1980 x 305 x 457 | ML450/4/1 | £211.91 | ML450/5/1 | £226.36 | ML450/6/1 | £240.91 |
| Nest of 2 | 1980 x 610 x 457 | ML450/4/2 | £391.87 | ML450/5/2 | £423.79 | ML450/6/2 | £455.69 |
| Nest of 3 | 1980 x 915 x 457 | ML450/4/3 | £574.88 | ML450/5/3 | £622.80 | ML450/6/3 | £670.73 |

Securistore - High Security Cabinets

These high security cabinets provide a convenient storage solution for a wide variety of valuable items either in the office or at home.

- Manufactured from 1.5mm thick folded steel sheet with a durable green epoxy-polyester coated finish and vents in the top and bottom of the sidewalls.
- Hardened, 7 lever, anti-pick locks are provided on single door cabinets. In addition, slam locks are fitted to double door cabinets.
- Wrap around welded construction severely restricts leverage with jemmys or screwdrivers.
- The cabinets can be secured to floors or walls through pre-drilled holes in back and bottom.

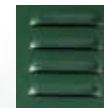

Ventilation top and bottom in side walls.



| Description | H x W x D (mm) | Order Ref | Price (Each) |
|--|------------------|-----------|--------------|
| Securistore Cabinet c/w 2 Key Locks & 1 Slam Lock - (Double) | 2000 x 900 x 500 | 015500 | £832.33 |
| Securistore Cabinet c/w 2 Key Locks - (Single) | 2000 x 475 x 500 | 015501 | £631.32 |
| Securistore Cabinet c/w 2 Key Locks & 1 Slam Lock - (Double) | 1400 x 900 x 500 | 015502 | £939.71 |
| Securistore Cabinet c/w 1 Key Lock - (Single) | 1400 x 475 x 500 | 015503 | £485.60 |
| Securistore Cabinet c/w 1 Key Lock - (Single) | 652 x 475 x 500 | 015504 | £464.59 |

Accessories

| Description | Order Ref | Price (Each) |
|------------------------------|-----------|--------------|
| Securistore Shelf - (Single) | 015505 | £28.07 |
| Securistore Shelf - (Double) | 015506 | £55.62 |

Safestore - Hazardous Substance Cabinets

The Hazardous Storage Cabinets are designed to provide safe storage of flammable liquids, chemicals, paints, pesticides and other hazardous substances. Comply with the Highly Flammable Liquids and Liquid Gases Regulations, Section 5 (1,D) and the guide to Regulation No. 5 (17) together with the Factory Inspectorates Certificate of Approval No. 1 parts 3 & 4.

- Constructed in 20 gauge mild steel, with welded seams
- Reinforced doors to prevent distortion and fitted with a two point lockable handle
- Adjustable shelves with 25mm pitches
- Built-in spillage sump, which is not removable
- Highly visible polyester powder coated in yellow with Highly Flammable warning labels
- Not fire or explosion proof but are designed to reduce risk to a minimum



| Description | H x W x D (mm) | Order Ref | Price (Each) |
|---|------------------|-----------|--------------|
| Hazardous Substance Cabinet c/w 1 Shelf | 457 x 457 x 305 | 016427 | £147.06 |
| Hazardous Substance Cabinet c/w 1 Shelf | 609 x 457 x 457 | 016428 | £162.94 |
| Hazardous Substance Cabinet c/w 1 Shelf | 915 x 457 x 457 | 016430 | £170.83 |
| Hazardous Substance Cabinet c/w 1 Shelf | 900 x 600 x 500 | 016419 | £160.77 |
| Hazardous Substance Cabinet c/w 1 Shelf | 711 x 915 x 457 | 016431 | £247.58 |
| Hazardous Substance Cabinet c/w 1 Shelf | 915 x 915 x 457 | 016432 | £264.37 |
| Hazardous Substance Cabinet c/w 2 Shelves | 1219 x 915 x 457 | 016438 | £342.36 |
| Hazardous Substance Cabinet c/w 2 Shelves | 1524 x 915 x 457 | 016439 | £381.19 |
| Hazardous Substance Cabinet c/w 3 Shelves | 1829 x 915 x 457 | 016433 | £400.41 |
| Hazardous Substance Cabinet Additional Shelf | 457 x 457 | 016435 | £29.04 |
| Hazardous Substance Cabinet Additional Shelf | 915 x 457 | 016436 | £29.04 |
| Hazardous Substance Cabinet Stand (suitable for 016431 & 016432 only) | 460 x 915 x 457 | 016434 | £84.34 |
| Hazardous Substance Flat Top Storage Bin | 508 x 609 x 330 | FLFT 1 | £146.62 |
| Hazardous Substance Flat Top Storage Bin | 609 x 1168 x 457 | FLFT 2 | £327.05 |
| Hazardous Substance Sloping Top Storage Bin | 660 x 609 x 330 | FLST 1 | £179.14 |
| Hazardous Substance Sloping Top Storage Bin | 760 x 1170 x 460 | FLST 2 | £332.00 |

Safestore - Acid Substance Cabinets

The Acid Substance Cabinets are designed to store acids safely, supplied with adjustable shelves and liquid tight sump tray

- Constructed in 20 gauge mild steel, with welded seams
- Reinforced doors to prevent distortion and fitted with a two point lockable handle
- Adjustable shelves with 25mm pitches
- Built-in spillage sump, which is not removable
- Highly visible polyester powder coated in white with appropriate warning labels



Note that these cabinets hold any acid based product. They are painted in one of the hardest paints available to provide a splash resistant finish.

| Description | H x W x D (mm) | Order Ref | Price (Each) |
|---|------------------|-----------|--------------|
| Acid Substance Cabinet c/w 1 Shelf | 457 x 457 x 305 | 016527 | £154.34 |
| Acid Substance Cabinet c/w 1 Shelf | 609 x 457 x 457 | 016528 | £177.29 |
| Acid Substance Cabinet c/w 1 Shelf | 915 x 457 x 457 | 016530 | £184.46 |
| Acid Substance Cabinet c/w 1 Shelf | 711 x 915 x 457 | 016531 | £263.56 |
| Acid Substance Cabinet c/w 1 Shelf | 915 x 915 x 457 | 016532 | £283.17 |
| Acid Substance Cabinet c/w 2 Shelves | 1219 x 915 x 457 | 016538 | £364.22 |
| Acid Substance Cabinet c/w 2 Shelves | 1524 x 915 x 457 | 016539 | £403.05 |
| Acid Substance Cabinet c/w 3 Shelves | 1829 x 915 x 457 | 016533 | £419.87 |
| Acid Substance Cabinet Additional Shelf | 457 x 457 | 016535 | £33.61 |
| Acid Substance Cabinet Additional Shelf | 915 x 457 | 016536 | £33.61 |
| Acid Substance Cabinet Stand | 460 x 915 x 457 | 016534 | £102.37 |

Suitable for Models: 016531 and 016532 only

Safestore - COSHH Substance Cabinets

The Cabinets are designed to satisfy the terms of the COSHH regulations by providing safe storage and isolation of hazardous substances.

- Constructed in 20 gauge mild steel, with lockable doors and built in spillage sump
- Adjustable shelves with 25mm pitches
- Reinforce doors to prevent distortion and fitted with a two point lockable handle
- Highly visible polyester powder coated in grey with a pack of 4 COSHH labels to be labelled as required
- Holds items such as cleaning fluids or products that carry the orange warning label



| Description | H x W x D (mm) | Order Ref | Price (Each) |
|--|------------------|-----------|--------------|
| COSHH Substance Cabinet c/w 1 Shelf | 457 x 457 x 305 | 016627 | £147.06 |
| COSHH Substance Cabinet c/w 1 Shelf | 609 x 457 x 457 | 016628 | £162.94 |
| COSHH Substance Cabinet c/w 1 Shelf | 915 x 457 x 457 | 016630 | £170.83 |
| COSHH Substance Cabinet c/w 1 Shelf | 711 x 915 x 457 | 016631 | £247.58 |
| COSHH Substance Cabinet c/w 1 Shelf | 915 x 915 x 457 | 016632 | £264.37 |
| COSHH Substance Cabinet c/w 2 Shelves | 1219 x 915 x 457 | 016638 | £342.36 |
| COSHH Substance Cabinet c/w 2 Shelves | 1524 x 915 x 457 | 016639 | £381.19 |
| COSHH Substance Cabinet c/w 3 Shelves | 1829 x 915 x 457 | 016633 | £400.41 |
| COSHH Substance Cabinet Additional Shelf | 457 x 457 | 016635 | £29.04 |
| COSHH Substance Cabinet Additional Shelf | 915 x 457 | 016636 | £29.04 |
| COSHH Substance Cabinet Stand | 460 x 915 x 457 | 016634 | £84.34 |

Suitable for Models: 016631, 016632 only

Safestore - Pesticide Substance Cabinets

Pesticides present a substantial danger to people and the environment when improperly stored. The Pesticide cabinets provide safe, secure storage of pesticides herbicides, fertilizers and other turf chemicals.

- Constructed in 20 gauge mild steel, with welded seams
- Reinforce doors to prevent distortion and fitted with a two point lockable handle
- Adjustable shelves with 25mm pitches
- Built-in spillage sump, which is not removable
- Highly visible polyester powder coated in red with appropriate warning label.



| Description | H x W x D (mm) | Order Ref | Price (Each) |
|--|------------------|-----------|--------------|
| Pesticide Substance Cabinet c/w 1 Shelf | 457 x 457 x 305 | 016727 | £180.80 |
| Pesticide Substance Cabinet c/w 1 Shelf | 609 x 457 x 457 | 016728 | £203.75 |
| Pesticide Substance Cabinet c/w 1 Shelf | 915 x 457 x 457 | 016730 | £210.93 |
| Pesticide Substance Cabinet c/w 1 Shelf | 711 x 915 x 457 | 016731 | £290.02 |
| Pesticide Substance Cabinet c/w 1 Shelf | 915 x 915 x 457 | 016732 | £309.64 |
| Pesticide Substance Cabinet c/w 2 Shelves | 1219 x 915 x 457 | 016738 | £390.69 |
| Pesticide Substance Cabinet c/w 2 Shelves | 1524 x 915 x 457 | 016739 | £429.52 |
| Pesticide Substance Cabinet c/w 3 Shelves | 1829 x 915 x 457 | 016733 | £446.34 |
| Pesticide Substance Cabinet Additional Shelf | 457 x 457 | 016735 | £33.61 |
| Pesticide Substance Cabinet Additional Shelf | 915 x 457 | 016736 | £33.61 |
| Pesticide Substance Cabinet Stand | 460 x 915 x 457 | 016734 | £102.37 |

Suitable for Models: 016731, 016732 only

Safestore - Flame-Safe Storage Bin

- Can safely store up to 150 litres of flammable liquids.
- Lid features a 50mm lip fitted with a strap that swells to seal the opening when heated.
- Manufactured from 16 gauge polyester coated steel.
- Conditions of licence for petroleum use are printed on the lid.
- Fitted with a hasp and staple closure and two carry handles.
- Suitable for both indoor and outdoor use.



| Description | H x W x D (mm) | Order Ref | Price (Each) |
|------------------------|-----------------|-----------|--------------|
| Flame-Safe Storage Bin | 685 x 915 x 635 | 017429FS | £497.93 |

Safestore - General Cabinet

Designed for the workshop, factory, automotive and many other applications. Supplied with one adjustable shelf and fitted with a tray to the top of the cabinet for retaining tools and components.

Fully welded construction with reinforced doors with 2 keys.



| Description | H x W x D (mm) | Order Ref | Price (Each) |
|--------------------------|-----------------|-----------|--------------|
| Tool Cabinet | 930 x 600 x 500 | 016409 | £133.56 |
| Additional Cabinet Shelf | | 016425 | £11.62 |

MATERIALS HANDLING EQUIPMENT

A comprehensive range of sack trucks, trolleys, cylinder/drum handling products and storage racks.

| Product | Lead Time (Working Days) | Page |
|---|-----------------------------|------|
| Toptruck - Sack Trucks, Platform Trucks and Trolleys | | |
| Trolleys and Sack Trucks | .(5-7) | 78 |
| Chair Truck | .(5-7) | 79 |
| Mesh Platform Trucks | .(5-7) | 85 |
| Utility Platform Trucks | .(5-7) | 86 |
| Bar/Premium Trucks | (7-10) | 89 |
| Utility Tray Trolleys | .(5-7) | 90 |
| Cylinder Handling | | |
| Cylinder Trolleys | .(5-7) | 92 |
| Wall Bracket & Stand | .(5-7) | 93 |
| Drum Handling | | |
| Stands | .(5-7) | 94 |
| Transporters | .(5-7) | 94 |
| Wheeled Dollys | .(5-7) | 95 |
| Trucks | .(5-7) | 95 |
| Racking | | |
| Sheet Racks | (7-10) | 96 |
| Bar Racks | (7-10) | 96 |
| Cable Dispensing | | |
| Toprax - Adjustable Cable Rack | (7-10) | 97 |
| Bench Top Cable Dispensers | .(5-7) | 97 |
| Cable Reel Stand | .(5-7) | 97 |
| Machinery Moving Equipment | | |
| Heavy Duty Skate Kit | .(5-7) | 98 |
| Roller Skate Kit | .(5-7) | 98 |
| Roller Crowbars | .(5-7) | 98 |

Toptruck - Sack Trucks, Platform Trucks and Trolleys

Toptruck - Folding Box Trolley

A practical trolley perfect for manoeuvring small parts whilst goods are kept partially secure and side enclosed.

- Extra lightweight
- Folds flat and fully extends in seconds
- Fitted with a telescopic aluminium handle
- Smooth plastic wheels fitted for easy transportation



| Product Description | Folded H x W x D (mm) | Open H x W x D (mm) | Order Ref | Capacity (Kgs) | Price |
|--------------------------------|-----------------------|---------------------|-----------|----------------|--------|
| Folding Box Trolley- Red/Black | 420 x 405 x 80 | 981 x 405 x 380 | FBT | 35 | £26.39 |

Toptruck - Light Duty Folding Sack Truck

A useful sack truck designed for lighter loads suitable for compact storage when not in use.

- Lightweight aluminium/steel sack truck
- Ideal for storing in the car
- Collapses and extends in just a few actions
- Fitted with extra luggage holding straps



| Product Description | Open H x W x D (mm) | Folded H x W x D (mm) | Toe Plate W x D (mm) | Order Ref | Capacity (kgs) | Price |
|-------------------------------|---------------------|-----------------------|----------------------|-----------|----------------|--------|
| Light Duty Folding Sack Truck | 1100 x 500 x 480 | 800 x 500 x 70 | 490 x 295 | AFST | 90 | £83.81 |

Toptruck - Telescopic Lightweight Hand Truck

A truck designed to transport small goods/parcels in almost any environment.

- Lightweight aluminium
- Collapses in overall size for compact storage
- Telescopic handle
- Folding footplate
- Fitted with rubber cushion wheels



| Product Description | H x W x D (mm) | Wheels (Ømm) | Toeplate W x D (mm) | Order Ref | Capacity (kgs) | Price (Each) |
|---------------------|------------------|--------------|---------------------|-----------|----------------|--------------|
| Fully Extended | 1105 x 400 x 410 | 150 | 355 x 240 | TAST | 90 | £39.80 |
| Collapsed | 740 x 400 x 180 | | | | | |

Toptruck - Standard/Heavy Duty Sack Trucks

These trucks are manufactured for frequent use.

The heavy duty truck version has a larger frame and wheels are positioned inside the truck frame to reduce the overall width allowing greater mobility.

- Heavy duty and standard duty options available
- A chair truck option is also available for moving multiple stacked chairs
- Either solid or open footplate versions are available
- Centre straps to provide stability on both models
- Rubber cushion wheels
- Blue powder coated frames



| Product Description | H x W x D (mm) | Wheels (Ømm) | Toeplate W x D (mm) | Order Ref | Capacity (kgs) | Price (Each) |
|--------------------------|------------------|--------------|---------------------|-----------|----------------|--------------|
| Standard Duty Sack Truck | 1000 x 425 x 420 | 200 | 305 x 240 | SDST | 150 | £92.00 |
| Heavy Duty Sack Truck | 1210 x 580 x 600 | 200 | 400 x 300 | HDST | 250 | £146.80 |
| Chair Truck | 1115 x 730 x 330 | 200 | H150 x W610 x D155 | CBLT | 75 | £95.00 |

Toptruck - Pneumatic Tyre Sack Truck

A sack truck fitted with pneumatic wheels designed to carry items over uneven surfaces.

- Concave framed
- Solid toeplate
- Wheel guards
- Powder coated in red



| Product Description | H x W x D (mm) | Wheels (Ømm) | Toeplate W x D (mm) | Order Ref | Capacity (kgs) | Price (Each) |
|---------------------------|------------------|--------------|---------------------|-----------|----------------|--------------|
| Pneumatic Tyre Sack Truck | 1155 x 550 x 450 | 260 | 350 x 200 | PTST | 150 | £44.72 |

Toptruck - Standard Heavy Duty Sack Barrow

A robust fully welded steel sack truck fitted with pneumatic tyres ideal for transporting heavier loads over rough terrain.

- 260mm diameter pneumatic tyres
- Rubber handles are with incorporated knuckle protectors
- Powder coated in blue



| Product Description | H x W x D (mm) | Toe Plate W x D (mm) | Order Ref | Capacity (Kgs) | Price |
|---------------------------------|------------------|----------------------|-----------|----------------|---------|
| Standard Heavy Duty Sack Barrow | 1180 x 590 x 555 | 380 x 305 | SHDSB | 300 | £105.03 |

Toptruck - Folding Foot Sack Truck

This truck offers an open tubular frame with a folding footplate for easy storage when not in use.

- Fitted with rubber cushion wheels
- Powder coated in red



HDFST HDFST Folded

| Product Description | H x W x D (mm) | Wheels (Ømm) | Toeplate W x D (mm) | Order Ref | Capacity (kgs) | Price (Each) |
|-------------------------|------------------|--------------|---------------------|-----------|----------------|--------------|
| Folding Foot Sack Truck | 1155 x 565 x 640 | 200 | 370 x 395 | HDFST | 90 | £45.20 |

Toptruck - 'P' Handle Sack Truck

A 'P' handled truck designed for one handed operation, when moving lighter/taller loads.

- Steel concave frame
- Pneumatic wheels
- Powder coated in red



| Product Description | H x W x D (mm) | Wheels (Ømm) | Toeplate W x D (mm) | Order Ref | Capacity (kgs) | Price (Each) |
|-----------------------|------------------|--------------|---------------------|-----------|----------------|--------------|
| 'P' Handle Sack Truck | 1310 x 540 x 475 | 260 | 350 x 220 | PHPTST | 200 | £45.48 |

Toptruck - Aluminium Sack Truck

A robust yet lightweight aluminium straight framed sack truck ideal for smaller goods/parcels.

- Fitted with knuckle protection hand grips
- Large pneumatic wheels
- Wheel guards
- Solid aluminium toeplate



| Product Description | H x W x D (mm) | Wheels (Ømm) | Toeplate W x D (mm) | Order Ref | Capacity (kgs) | Price (Each) |
|----------------------|------------------|--------------|---------------------|-----------|----------------|--------------|
| Aluminium Sack Truck | 1120 x 500 x 475 | 260 | 300 x 200 | AST | 80 | £69.63 |

Toptruck - Two Position Cargo Truck

This truck can transform easily from a conventional sack truck into a four wheeled platform trolley and designed to cope with transporting items over uneven surfaces.

- 250mm diameter pneumatic wheels
- Tubular steel construction
- Powder coated in red



TPCT

| Product Description | Sack Truck H x W x D (mm) | Platform Trolley H x W x D (mm) | Toe Plate W x D (mm) | Order Ref | Capacity (Kgs) | Price |
|--------------------------|---------------------------|---------------------------------|----------------------|-----------|----------------|--------|
| Two Position Cargo Truck | 1200 x 620 x 550 | 930 x 1200 x 550 | 335 x 330 | TPCT | 250 | £77.03 |

Toptruck - 3 Position Truck

A truck designed to convert from a basic sack truck into either a four wheeled angled sack truck or platform truck.

- Fitted with 100mm diameter double rear castors that provide extra stability
- Construction on frame is a steel square tube
- Powder coated in red



3PT

| Product Description | Overall size H x W x D (mm) | Toe Plate W x D (mm) | Order Ref | Capacity (kgs) | Price |
|---------------------|-----------------------------|----------------------|-----------|----------------|---------|
| 3 Position Truck | 1290 x 470 x 450 | 470 x 190 | 3PT | 300 | £105.03 |

Toptruck - Two Position Sack Truck

These trucks can easily re-form from a sack truck to a four wheeled flatbed trolley without the use of any tools.

- Frame constructed from aluminium
- Fitted with black powder coated steel toeplate
- Fitted with large pneumatic wheels and non-marking rear castors



| Product Description | H x W x D (mm) | Wheels (Ømm) | Toeplate W x D (mm) | Order Ref | Capacity (kgs) | Price (Each) |
|---------------------|-------------------|------------------------------------|---------------------|-----------|----------------|--------------|
| Sack Truck | 1365 x 505 x 510 | 260 Pneumatic | 460 x 230 | 2PT | 120 | £138.40 |
| Flatbed | 1070 X 505 X 1190 | 260 Pneumatic & 130 Rubber Cushion | | | | |

Toptruck - Folding Foot Stairclimber

A sack truck designed to climb stairs and pavements because of the innovative tri-star wheels.

- Supplied with rubber cushioned wheels
- Tubular steel frame construction
- Folding foot toeplate
- Wheels fitted with steel hubs
- Powder coated in blue



| Product Description | H x W x D (mm) | Wheels (Ømm) | Toeplate W x D (mm) | Order Ref | Capacity (kgs) | Price (Each) |
|---------------------------|------------------|--------------|---------------------|-----------|----------------|--------------|
| Folding Foot Stairclimber | 1150 x 605 x 765 | 6 x 160 | 365 x 365 | FFS | 120 | £92.30 |

Toptruck - Extendable Trolley

This smart trolley can adapt to various load sizes as the overall base length can easily be extended.

- Aluminium framed
- Collapses fully for compact storage
- Fitted with a telescopic handle
- Moulded plastic corner buffers for added protection



MPT100 Collapsed

MPT100 Fully Extended

| Product Description | H x W x D (mm) | Wheels (Ømm) | Order Ref | Capacity (kgs) | Price (Each) |
|---------------------|-----------------|--------------|-----------|----------------|--------------|
| Fully Extended | 825 x 430 x 710 | 100 | MPT100 | 100 | £67.48 |
| Collapsed | 235 x 430 x 510 | | | | |

Toptruck - 1 Tier Platform Truck

This truck is ideal for use in shops, offices, schools and warehouses.

- The base is manufactured in wipe clean reinforced injection moulded plastic
- Epoxy powder coated steel foldable handle
- Fitted with non-marking wheels and castors



PPT200 Folded

PPT200

| Product Description | H x W x D (mm) | Folded Height (mm) | Wheels (Ømm) | Order Ref | Capacity (kgs) | Price (Each) |
|-----------------------|-----------------|--------------------|--------------|-----------|----------------|--------------|
| 1 Tier Platform Truck | 820 x 500 x 800 | 160 | 100 | PPT200 | 200 | £88.40 |

Toptruck - Folding Flatbed Trolleys

A sturdy range of steel trolleys suitable to manoeuvre smaller goods ideal for indoor and outdoor use.

- Folds flat for compact storage
- Fitted with non-slip rubber platforms and scuff resistant corners
- Fitted with non-marking wheels and castors
- Powder coated steel handles



PFBT150

PFBT300

| Product Description | H x W x D (mm) | Folded Height (mm) | Wheels (Ømm) | Order Ref | Capacity (kgs) | Price (Each) |
|---------------------|-----------------|--------------------|--------------|-----------|----------------|--------------|
| Folding Flatbed | 810 x 470 x 730 | 230 | 100 | PFBT150 | 150 | £44.25 |
| Folding Flatbed | 870 x 608 x 907 | 285 | 125 | PFBT300 | 300 | £88.56 |

Toptruck - Rough Terrain Platform Truck

Steel constructed truck useful to cart items over uneven terrain

- Fitted with pneumatic wheels
- Fitted with non-slip rubber platforms and scuff resistant corners
- Foldable for easy storage
- Powder coated steel handles



PRTT Folded

PRTT

| Product Description | H x W x D (mm) | Folded Height (mm) | Wheels (Ømm) | Order Ref | Capacity (kgs) | Price (Each) |
|------------------------------|-----------------|--------------------|--------------|-----------|----------------|--------------|
| Rough Terrain Platform Truck | 945 x 608 x 907 | 375 | 200 | PRTT | 300 | £135.21 |

Toptruck - Shelf Trolleys

A lightweight range of trolleys suited to transport items in offices, schools, shops, workshops, warehouses and factories.

- Elegant chrome finish tubular steel frames
- Pressed steel shelves
- Angled handles fitted to aid manoeuvrability
- Shelves have non-slip rubber surfaces
- Scuff resistant corners
- Fitted with non-marking wheels



PST3

PST2

| Product Description | H x W x D (mm) | Wheels (Ømm) | Shelf Height (mm) | Order Ref | Capacity (kgs) | Price (Each) |
|---------------------|-----------------|--------------|-------------------|-----------|----------------|--------------|
| 2 x Shelf Trolley | 950 x 470 x 725 | 100 | 140/680 | PST2 | 120 | £112.65 |
| 3 x Shelf Trolley | 950 x 470 x 725 | 100 | 140/410/680 | PST3 | 120 | £119.17 |

Toptruck - General Store Trolley

This trolley is designed to convert from a three sided truck to a two tier trolley perfect for transporting goods in warehouses, factories, workshops and stores.

- Manufactured from mild steel
- Flip/hinged top shelf
- Fitted with non-marking rubber castors
- Epoxy powder coated finish



| Product Description | H x W x D (mm) | Wheels (Ømm) | Order Ref | Capacity (kgs) | Price (Each) |
|-----------------------|------------------|--------------|-----------|----------------|--------------|
| General Store Trolley | 1000 x 750 x 510 | 125 | GST1 | 150 | £225.00 |

Toptruck - 1 Drawer Tool Trolley

A tool trolley fitted with a central drawer for use in garages, workshops and warehouses.

- Fitted with a handle for easier transportation purposes
- Lipped shelves prevent stored items from slipping off
- Two swivel and two fixed 125mm diameter solid wheels
- Powder coated in red



1DTT

| Product Description | H x W x D (mm) | Order Ref | Capacity (Kgs) | Price |
|-----------------------|-----------------|-----------|----------------|---------|
| 1 Drawer Tool Trolley | 820 x 840 x 410 | 1DTT | 100 | £124.04 |

Toptruck - Heavy Duty Tray Trolleys

Robust trolleys that can be used in almost any environment.

- Fully welded steel construction
- Three fixed shelves
- 40mm lip designed on shelves to prevent goods from slipping off
- Two fixed and two swivel rubber cushion wheels
- Powder coated in blue



HDTT2

HDTT1

| Product Description | H x W x D (mm) | Trays W x D (mm) | Wheels (Ømm) | Shelf Height (mm) | Order Ref | Capacity (kgs) | Price (Each) |
|-------------------------------|-------------------|------------------|--------------|-------------------|-----------|----------------|--------------|
| Small Heavy Duty Tray Trolley | 860 x 500 x 1050 | 500 x 900 | 160 | 255/560/860 | HDTT1 | 350 | £295.00 |
| Large Heavy Duty Tray Trolley | 1160 x 500 x 1050 | 500 x 900 | 160 | 255/705/1160 | HDTT2 | 350 | £320.00 |

Toptruck - Mesh Flatbed Platform Truck

An ideal truck useful designed to move heavier items over even or uneven surfaces.

- Reinforced mesh steel platform/base
- Designed with a 40mm raised edge on the platform to prevent goods from sliding off
- Large pneumatic wheels with extra rubber tread
- Comfort handle for easy mobility
- Powder coated in green



TTFB Empty



TTFB Fully Loaded

| Product Description | H x W x D (mm) | Wheels (Ømm) | Platform Height (mm) | Order Ref | Capacity (kgs) | Price (Each) |
|-----------------------------|------------------|--------------|----------------------|-----------|----------------|--------------|
| Mesh Flatbed Platform Truck | 990 x 608 x 1365 | 260 | 380 | TTFB | 350 | £134.45 |
| Internal Flatbed Dimensions | W600 x D1207 | | | | | |

Toptruck - Mesh Sided Platform Truck

A four sided mesh platform truck that has the option to drop down the side panels for ease when loading goods onto platform. Suited to cope with carrying items over flat or rough terrain.

- Handle to aid manoeuvrability
- 150mm high sides
- Large pneumatic wheels with extra rubber tread
- Powder coated in green



TT4S Empty



TT4S Fully Loaded

| Product Description | H x W x D (mm) | Wheels (Ømm) | Platform Height (mm) | Order Ref | Capacity (kgs) | Price (Each) |
|---------------------------|---|--------------|----------------------|-----------|----------------|--------------|
| Mesh Sided Platform Truck | (935 Handle/538 Mesh Cage) x 530 x 1160 | 260 | 320 | TT4S | 250 | £143.19 |
| Internal Cage Dimensions | W 480 x D 930 | | | | | |

Utility Platform Trucks

A selection of single ended and base only trolleys suitable for heavy work loads in warehouses, workshops and factories.

- Plywood decks supplied on all the trolley versions
- Angled handles designed for manoeuvring trolley
- Steel tubular slot together and bolt system
- Braked and unbraked trolleys available
- Frame powder coated in blue
- 200mm Ø rubber wheels
- Capacity = 400kg (UDL)
- Platform height: 285mm

| Product Description | H x W x D (mm) | Braked Trolleys | | Unbraked Trolleys | |
|--|------------------|-----------------|--------------|-------------------|--------------|
| | | Order Ref | Price (Each) | Order Ref | Price (Each) |
| Single Ended with Open Handle (Small) | 900 x 500 x 900 | UPT101/BC | £265.00 | UPT101 | £235.00 |
| Single Ended with Open Handle (Large) | 900 x 700 x 1100 | UPT201/BC | £275.00 | UPT201 | £245.00 |
| Single Ended with Handle and Plywood (Small) | 900 x 500 x 900 | UPT103/BC | £275.00 | UPT103 | £245.00 |
| Single Ended with Handle and Plywood (Large) | 900 x 700 x 1100 | UPT203/BC | £285.00 | UPT203 | £255.00 |
| Single Ended with Handle and Mesh (Small) | 900 x 500 x 900 | UPT104/BC | £280.00 | UPT104 | £255.00 |
| Single Ended with Handle and Mesh (Large) | 900 x 700 x 1100 | UPT204/BC | £295.00 | UPT204 | £265.00 |



Utility Platform Trucks

Double ended trolleys suitable for heavy work loads in warehouses, workshops and factories.

- Plywood decks supplied on all the trolley versions
- Angled handles designed for manoeuvring trolley
- Steel tubular slot together and bolt system
- Braked and unbraked trolleys available
- Frame powder coated in blue
- 200mm Ø rubber wheels
- Capacity = 400kg (UDL)
- Platform height: 285mm

| Product Description | H x W x D (mm) | Braked Trolleys | | Unbraked Trolleys | |
|--|------------------|-----------------|--------------|-------------------|--------------|
| | | Order Ref | Price (Each) | Order Ref | Price (Each) |
| Double Ended with Open Handle (Small) | 900 x 500 x 900 | UPT105/BC | £315.00 | UPT105 | £285.00 |
| Double Ended with Open Handle (Large) | 900 x 700 x 1100 | UPT205/BC | £325.00 | UPT205 | £295.00 |
| Double Ended with Handle and Plywood (Small) | 900 x 500 x 900 | UPT106/BC | £330.00 | UPT106 | £295.00 |
| Double Ended with Handle and Plywood (Large) | 900 x 700 x 1100 | UPT206/BC | £345.00 | UPT206 | £315.00 |
| Double Ended with Handle and Mesh (Small) | 900 x 500 x 900 | UPT107/BC | £345.00 | UPT107 | £315.00 |
| Double Ended with Handle and Mesh (Large) | 900 x 700 x 1100 | UPT207/BC | £365.00 | UPT207 | £335.00 |



Utility Platform Trucks

Three and four sided trolleys suitable for heavy work loads in warehouses, workshops etc.

- Plywood decks supplied on all the trolley versions
- Angled handles designed for manoeuvring trolley
- Steel tubular slot together and bolt system
- Braked and unbraked trolleys available
- Frame powder coated in blue
- 200mm dia. rubber wheels
- Capacity = 400kg (UDL)
- Platform height: 285mm

| Product Description | Braked Trolleys | | | Unbraked Trolleys | |
|----------------------------------|------------------|-----------|--------------|-------------------|--------------|
| | H x W x D (mm) | Order Ref | Price (Each) | Order Ref | Price (Each) |
| Three Sided with Plywood (Small) | 900 x 500 x 900 | UPT108/BC | £340.00 | UPT108 | £310.00 |
| Three Sided with Plywood (Large) | 900 x 700 x 1100 | UPT208/BC | £360.00 | UPT208 | £330.00 |
| Three Sided with Mesh (Small) | 900 x 500 x 900 | UPT109/BC | £370.00 | UPT109 | £340.00 |
| Three Sided with Mesh (Large) | 900 x 700 x 1100 | UPT209/BC | £395.00 | UPT209 | £365.00 |
| Four Sided with Plywood (Small) | 900 x 500 x 900 | UPT110/BC | £350.00 | UPT110 | £325.00 |
| Four Sided with Plywood (Large) | 900 x 700 x 1100 | UPT210/BC | £380.00 | UPT210 | £350.00 |
| Four Sided with Mesh (Small) | 900 x 500 x 900 | UPT111/BC | £395.00 | UPT111 | £365.00 |
| Four Sided with Mesh (Large) | 900 x 700 x 1100 | UPT211/BC | £425.00 | UPT211 | £395.00 |



UPT209

UPT108



UPT110

UPT211

Bar/Premium Trucks

Specially designed trucks available in a choice of various capacities to suit most environments.

- Both ranges manufactured from tough, 100% food grade medium density polypropylene.
- Smooth interiors for easy cleaning
- Fitted with nylon wheels/castors
- Available in blue only

Bar Trucks

- Available in the best selling 2 sizes without lids
- Stackable and nestable
- Specially produced for hotels, bars or work environments where space is at a premium
- Both models fitted with 4 swivel castors
- Designed for confined spaces and storage of empty bottles and general waste.
- Handles added



BT135B



BT150B

| Product Description | Wheels (Ømm) | External H x W x D (mm) | Internal H x W x D (mm) | Order Ref | Price (Each) |
|---------------------|--------------|-------------------------|-------------------------|-----------|--------------|
| 135 Ltr Bar Truck | 50 | 660 x 650 x 460 | 580 x 600 x 390 | BT135B | £87.50 |
| 150 Ltr Bar Truck | 50 | 750 x 615 x 455 | 685 x 555 x 400 | BT150B | £90.00 |

Premium Trucks

- Available in the best selling 3 sizes with or without lids
- Fully nestable for making transportation easier and highly cost effective
- Ideal for storage and transportation in factories, retail outlets and catering
- (PT135B) fitted with 4 swivel castors and (PT300B/PT400B) are fitted with both 2 swivel castors / 2 fixed wheels
- The 2 larger sizes are fitted with recessed plastic bases for additional strength and support



PT135B + PTL135B



PT300B + PTL300B



PT400B + PTL400B

| Product Description | Wheels (Ømm) | External H x W x D (mm) | Internal H x W x D (mm) | Order Ref | Price (Each) |
|-----------------------------------|--------------|-------------------------|-------------------------|-----------|--------------|
| 135 Ltr Premium Truck | 75 | 690 x 620 x 530 | 580 x 550 x 465 | PT135B | £102.50 |
| Lid to suit 135 Ltr Premium Truck | - | - | - | PTL135B | £32.50 |
| 300 Ltr Premium Truck | 100 | 735 x 1010 x 685 | 595 x 905 x 585 | PT300B | £158.00 |
| Lid to suit 300 Ltr Premium Truck | - | - | - | PTL300B | £40.00 |
| 400 Ltr Premium Truck | 100 | 755 x 1345 x 730 | 620 x 1225 x 595 | PT400B | £190.00 |
| Lid to suit 400 Ltr Premium Truck | - | - | - | PTL400B | £58.00 |

Utility Tray Trolleys

A unique range of robust tray trolleys designed for most environments, including warehouses, garages, workshops, catering, serving and general everyday use. The specially formed aluminium uprights and ribbed plastic shelves provide strength, durability and stability. The trolleys are also fitted with hardwearing (100mm Dia.) thermoplastic swivel rubber castors (2 braked).

2 Shelf Trolleys



| Product Description | H x W x D (mm) | Shelves L x W (mm) | Capacity (kg) | Order Ref | Price (Each) |
|----------------------|-----------------|--------------------|---------------|-----------|--------------|
| (Standard) 2 Shelves | 940 x 460 x 750 | 630 x 424 | 100 | WHTT2SS | £110.00 |
| (Large) 2 Shelves | 970 x 513 x 990 | 866 x 500 | 120 | WHTT2SL | £170.00 |

3 Shelf Trolleys



| Product Description | H x W x D (mm) | Shelves L x W (mm) | Capacity (kg) | Order Ref | Price (Each) |
|----------------------|------------------|--------------------|---------------|-----------|--------------|
| (Standard) 3 Shelves | 980 x 460 x 750 | 630 x 424 | 150 | WHTT3SS | £130.00 |
| (Large) 3 Shelves | 1010 x 513 x 990 | 866 x 500 | 200 | WHTT3SL | £215.00 |

3 Shelf Trolleys - Sides/Back Enclosed

- Supplied with additional side panels on 3 sides to form a secure enclosure



| Product Description | H x W x D (mm) | Shelves L x W (mm) | Capacity (kg) | Order Ref | Price (Each) |
|--|------------------|--------------------|---------------|------------|--------------|
| (Standard) 3 Shelves c/w Sides/Back Enclosed | 980 x 460 x 750 | 630 x 424 | 150 | WHTT3SS/SB | £165.00 |
| (Large) 3 Shelves c/w Sides/Back Enclosed | 1010 x 513 x 990 | 866 x 500 | 200 | WHTT3SL/SB | £275.00 |

3 Shelf Trolleys with Accessories

- Supplied with 3 Plastic Bin Trays (W575 x D430 x H180mm)
- Supplied with 2 Plastic Side Bins (25 Ltr) (W385 x D265 x H480mm)



| Product Description | H x W x D (mm) | Shelves L x W (mm) | Capacity (kg) | Order Ref | Price (Each) |
|--------------------------------------|-------------------|--------------------|---------------|-------------|--------------|
| (Standard) 3 Shelves c/w Accessories | 1010 x 460 x 1090 | 630 x 424 | 150 | WHTT3SS/ACC | £185.00 |

2 Shelf Trolleys with Drawer

WHTT2SS/D1

- Lockable drawer with 2 keys supplied
- Inner rubber mat supplied to fit in drawer

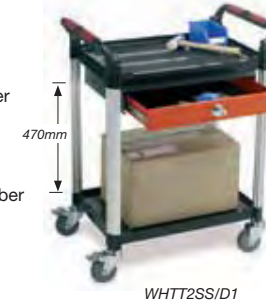

WHTT2SS/D2

- Double drawer supplied with inner rubber mats



| Product Description | H x W x D (mm) | Shelves L x W (mm) | Capacity (kg) | Order Ref | Price (Each) |
|--|-----------------|--------------------|---------------|------------|--------------|
| (Standard) 2 Shelves c/w 1 Drawer - 2 keys | 940 x 460 x 750 | 630 x 424 | 100 | WHTT2SS/D1 | £220.00 |
| (Standard) 2 Shelves c/w 2 Drawer - 2 keys | 940 x 460 x 750 | 630 x 424 | 100 | WHTT2SS/D2 | £255.00 |

3 Shelf Trolleys with Drawer and Cabinet

- Lockable cabinet and drawer, with 4 keys supplied
- Cabinet door has a unique opening system without a hinge



| Product Description | H x W x D (mm) | Shelves L x W (mm) | Capacity (kg) | Order Ref | Price (Each) |
|---|-----------------|--------------------|---------------|-------------|--------------|
| (Standard) 3 Shelves c/w 1 Drawer, 2 Keys and Cabinet, 2 keys | 980 x 460 x 750 | 630 x 424 | 150 | WHTT3SS/CAB | £375.00 |

Cylinder Handling

A range of storage and handling solutions for the safekeeping and movement of gas cylinders around your premises. All trolleys are of tubular steel construction powder coated in blue with a pierced base plate to help disperse condensation. Trolleys and wall brackets are fitted with a galvanised chain to hold cylinders securely. All rear wheel models are fitted with 100mm diameter swivel blue vulcanised rubber castors, which offers low rolling resistance, meaning they are easy to manoeuvre, are non marking and are a soft yet highly durable compound.



Single Cylinder Trolleys

| Product Description | Wheels (Ømm) | Max Cylinder (Ømm) | H x W x D (mm) | Order Ref | Trolley Capacity (kgs) | Price (Each) |
|---|--------------|--------------------|------------------|------------------|------------------------|--------------|
| Single Cylinder Trolley | 200 | 280 | 1050 x 483 x 520 | SCT/280 | 150 | £94.49 |
| Single Cylinder Trolley c/w Rear Wheels | 200 + 100 | 280 | 1050 x 483 x 900 | SCT/280/RW | 150 | £162.68 |
| Single Cylinder Rear Wheel Attachment | 100 | - | - | RW/PT/47/SCT/280 | - | £67.78 |

47kg Propane Cylinder Trolleys



| Product Description | Wheels (Ømm) | Max Cylinder (Ømm) | H x W x D (mm) | Order Ref | Trolley Capacity (kgs) | Price (Each) |
|--|--------------|--------------------|------------------|------------------|------------------------|--------------|
| Propane Cylinder Trolley | 200 | 380 | 1050 x 583 x 520 | PT/47 | 150 | £94.49 |
| Propane Cylinder Trolley c/w Rear Wheels | 200 + 100 | 380 | 1050 x 583 x 900 | PT/47/RW | 150 | £162.28 |
| Propane Cylinder Rear Wheel Attachment | 100 | - | - | RW/PT/47/SCT/280 | - | £67.78 |

Oxygen Acetylene Cylinder Trolleys



| Product Description | Wheels (Ømm) | Max Cylinder (Ømm) | H x W x D (mm) | Order Ref | Trolley Capacity (kgs) | Price (Each) |
|--|--------------|--------------------|------------------|--------------|------------------------|--------------|
| Oxygen Acetylene Cylinder Trolley | 300 | 240 / 290 | 1050 x 760 x 520 | OACT | 200 | £156.27 |
| Oxygen Acetylene Cylinder Trolley c/w Rear Wheel | 300 + 100 | 240 / 290 | 1050 x 760 x 900 | OACT/RW | 200 | £246.27 |
| Oxygen Acetylene Rear Wheel Attachment | 100 | - | - | RW/OACT/OPCT | - | £90.00 |

Oxygen Propane Cylinder Trolleys



| Product Description | Wheels (Ømm) | Max Cylinder (Ømm) | H x W x D (mm) | Order Ref | Trolley Capacity (kgs) | Price (Each) |
|--|--------------|--------------------|------------------|--------------|------------------------|--------------|
| Oxy Propane Cylinder Trolley | 300 | 240/410 | 1050 x 880 x 520 | OPCT | 200 | £169.14 |
| Oxy Propane Cylinder Trolley c/w Rear Wheels | 300 + 100 | 240/410 | 1050 x 880 x 900 | OPCT/RW | 200 | £259.14 |
| Oxy Propane Rear Wheel Attachment | 100 | - | - | RW/OACT/OPCT | - | £90.00 |

Cylinder Wall Brackets

- For stability and safe storage of cylinders.
- Cylinders secured by galvanised chain.
- Epoxy powder coated in blue.
- Wall fixings not included.



| Product Description | Max Cylinder (Ømm) | H x W x D (mm) | Order Ref | Price (Each) |
|---|--------------------|----------------|-----------|--------------|
| Cylinder Wall Bracket for Two Cylinders | 280 | 40 x 650 x 155 | CWB/2W | £45.00 |
| Cylinder Wall Bracket for Three Cylinders | 280 | 40 x 965 x 155 | CWB/3W | £54.00 |

Cylinder Stand

- For stability and safe storage of gas cylinders.
- Cylinders secured by hinged bar and winged nuts.
- Epoxy powder coated in blue.
- Heavy duty base plate can be floor fixed (*fixings not supplied*).



| Product Description | Max Cylinder (Ømm) | H x W x D (mm) | Order Ref | Price (Each) |
|---------------------|--------------------|-----------------|-----------|--------------|
| Cylinder Stand | 280 | 600 x 340 x 310 | CS/280 | £98.00 |

Drum Handling

A range of handling solutions for the safe movement of 210 litre steel drums around your premises. All equipment is powder coated in blue.

Drum Stands

- For use with 210 litre steel drums.
- Enables drums to be moved from a vertical to horizontal position for decanting or storage.
- Manufactured using four support straps for increased loading capacity.
- All wheels, castors and drum rollers are white nylon 80mm diameter (where included).



| Product Description | H x W x D (mm) | Height to Underside of Drum when Loaded on to Stand | Order Ref | Capacity (kgs) | Price (Each) |
|--|-----------------|---|-----------|----------------|--------------|
| Drum Stand | 400 x 430 x 780 | 300mm | DS1 | 250 | £88.00 |
| Mobile Drum Stand with drum rollers | 430 x 430 x 780 | 347mm | DS2 | 250 | £125.00 |
| Mobile Drum Stand without drum rollers | 430 x 430 x 780 | 320mm | DS3 | 250 | £115.00 |
| Static Drum Stand with drum rollers | 400 x 430 x 780 | 330mm | DS4 | 250 | £105.00 |

Universal Drum Transporter

This tough durable all welded steel construction drum transporter is designed to accept 210 litre steel drums. Drums can be transported in a horizontal position when the handle is engaged, and is fitted with drum rollers to allow rotation of the drum for decantation. A handle is supplied to enable quick loading/unloading of the drum. Each supplied with 200mmØ solid rubber and 80mmØ Nylon wheels/ castors.



| Product Description | H x W x D (mm) | Height to Underside of Drum when Loaded on to Stand | Order Ref | Capacity (kgs) | Price (Each) |
|---|-----------------|---|-----------|----------------|--------------|
| Universal Drum Transporter/ Stand with Handle | 540 x 620 x 800 | 387mm | UDT | 250 | £295.00 |

Drum Up and Down Enders

The DUE allows 210 litre steel drums to be moved from a horizontal to a vertical position.

The DUE/DE allow drums to be moved from a horizontal to a vertical position and vice versa.



| Product Description | H x W (mm) | Order Ref | Capacity (kgs) | Price (Each) |
|---------------------------------------|------------|-----------|----------------|--------------|
| Drum Up Ender c/w Handles | 1335 x 300 | DUE | 250 | £70.80 |
| Drum Up Down Ender c/w Handles / Knob | 1680 x 720 | DUE/DE | 250 | £95.00 |

Drum Dollies



3 Wheeled Drum Dolly

Ref: 3WDD
 Price: £88.15 Each
 Size: 735mm x 125mm high overall
 Castors: 75mmØ - White Nylon
 Capacity: 250kg

(Design allows for loading by drum truck) - See below.

4 Wheeled Drum Dolly

Ref: 4WDD
 Price: £108.50 Each
 Size: 742mm x 160mm high overall
 Castors: 75mmØ - White Nylon
 Capacity: 250kg

(Design allows for loading by an overhead lifting device)

Drum Trucks

Fitted with a drum-retaining hook suitable for handling tight head and open top 210 litre steel drums.

- Enables easy mobility of 210 litre steel drums
- Available with or without rear wheels. The real wheel attachment considerably reduces operator effort
- Both drum trucks come with full operating instructions.
- All rear wheel models are fitted with 100mm diameter swivel blue vulcanised rubber castors and 250 Ø rubber wheels, which offers low rolling resistance, meaning they are easy to manoeuvre, are non marking and a soft yet highly durable compound.



| Product Description | H x W x D (mm) | Order Ref | Capacity (kgs) | Price (Each) |
|----------------------------------|------------------|-----------|----------------|--------------|
| Drum Truck | 1520 x 610 x 420 | DT | 280 | £195.00 |
| Drum Truck c/w Rear Wheels | 1520 x 610 x 420 | DT/RW | 280 | £265.00 |
| Drum Truck Rear Wheel Attachment | - | RW/DT | - | £76.80 |

Racking

Sheet Rack

Sheet racks simplify the storage and access problems of all sheet material, panels and boards. Minimum base frame height makes loading very easy. It is recommended that the racks are secured to the floor (No fixings are included). Supplied in knocked down form. Racks are powder coated in blue and have 3 storage divisions spaced nominally at 155mm apart.



| Product Description | H x W x D (mm) | Order Ref | Price (Each) |
|---------------------|-----------------|-----------|--------------|
| Sheet Rack | 900 x 600 x 600 | SR/0.6 | £252.28 |

Bar Racks

Heavy-duty horizontal bar racks are freestanding units for the storage of bars, pipes and tubes etc. End stops retain products in position. Pre-drilled for floor fixing (no fixings included). These units are powder coated in blue and require no bracing, therefore can be positioned as required.

Racks can be positioned back to back to provide double-sided units.

Maximum capacity per rack- 4000 kgs

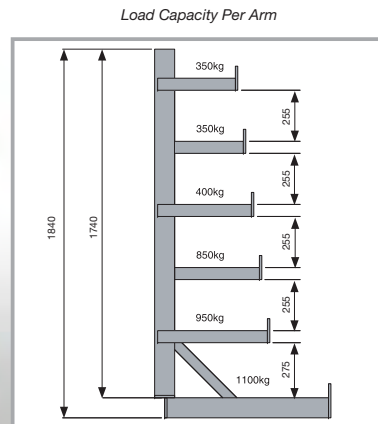
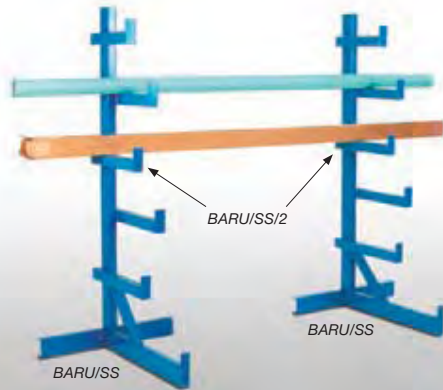

| Product Description | H x W x D (mm) | Order Ref | Price |
|---------------------------------------|---------------------------|-----------|--------------------|
| Bar Rack Single Unit | 1832 x 840 x 890 | BARU/SS | £371.00 (Each) |
| Bar Rack Double Unit (as shown above) | 2 x single unit, as above | BARU/SS/2 | £742.00 (Per Pair) |

Cable Dispensing

Toprax - Adjustable Cable Rack

- Used for storing and dispensing reels of wire/cable.
- Supplied with 4 fully adjustable hanging rails (Ø 31.75 x L 818mm - actual hanging length).
- Powder coated finish in blue & silver/grey.
- A clip together system with no tools required.
- Extension fitting kits are available and must be used if creating a double height rack by stacking two racks (020434) together.

| Description | H x W x D(mm) | Order Ref | Price (Per Kit) |
|-----------------------|-----------------|-----------|-----------------|
| Cable Rack | 983 x 942 x 328 | 020434 | £138.84 |
| Extension Fitting Kit | - | 020162K | £30.06 |

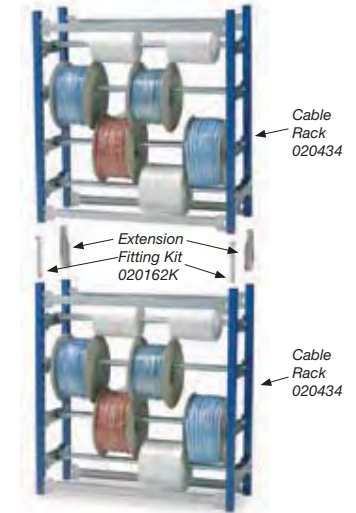

Bench Top Cable Dispensers

This handy cable dispenser provides a practical and economic way to store and dispense a wide range of wire/cables. Its compact size makes it ideal for bench top mounting and where space is at a premium, can be used with a capacity range upto 350mm diameter reels.

- Robust construction fully welded tubular steel frames, epoxy coated for greater durability.



800090 YELLOW

| Max Reel (Ømm) | Min Reel Core (Ømm) | Max Storage Width (mm) | Order Ref | Price (Each) |
|----------------|---------------------|------------------------|---------------|--------------|
| 350 | 20 | 290 | 800088 YELLOW | £29.80 |
| 350 | 20 | 590 | 800090 YELLOW | £34.80 |

Floor Mounted Cable Reel Stand

A light weight yet robust unit, which can ease cable handling problems, frequently encountered during installation work.

Once the cable has been placed on the stand, it is free to rotate during unreeling, but it is retained in position to maintain stability.

The stand has two adjustable full width rollers to accommodate a range of cable reel/drum sizes. For larger heavier drums, two stands can be used, one under each drum flange.



| Max Reel (Ømm) | Min Reel (Ømm) | Max Reel Width (mm) | Max Reel Weight (kg) | Order Ref | Price (Each) |
|----------------|----------------|---------------------|----------------------|-----------|--------------|
| 740 | 120 | 520 | 140 | 017435 | £195.00 |

Machinery Moving Equipment

Heavy Duty Skate Kit

This complete kit is designed to enable the safe and easy movement of bulky loads for up to 20 tons in any direction.

- Can be used as single or multiple units.
- Moving speed not to exceed 5m/min.
- Minimum turning circle is 3m.
- Supplied in a robust steel carry case.
- Roller dimensions: W 51 x 17mmØ.
- 94mm skate height with turntable attached.

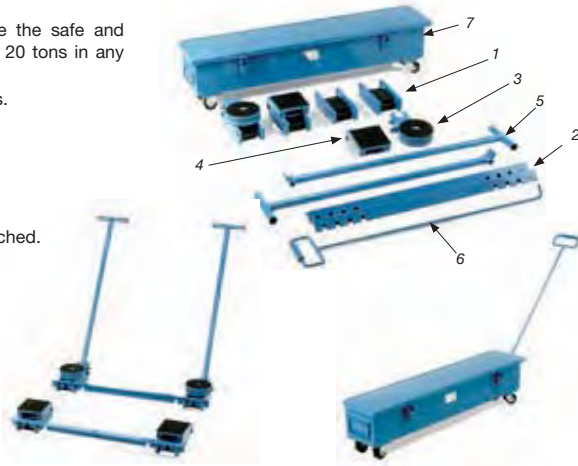

Kit supplied complete with:

| No. | Description | Qty |
|-----|-----------------------|-----|
| 1 | Roller Skates | 4 |
| 2 | Link Up Bars | 2 |
| 3 | Turntables | 2 |
| 4 | Stabilizers | 2 |
| 5 | Steering Handle | 2 |
| 6 | Handle for Steel Case | 1 |
| 7 | Steel Case | 1 |

| Product Description | L X W X H (mm) | Order Ref | Capacity (Tonnes) | Price (Each) |
|--------------------------------|------------------|-----------|-------------------|--------------|
| Heavy Duty Machinery Skate Kit | 1030 x 205 x 175 | HDMSK | 20 | £965.00 |

Roller Skate Kit

Roller skates are designed to move heavy equipment and machinery.

- Supplied in a set of 4.
- Movement enabled by the action of an endless hardened roller chain revolving around the centre member of the skate casting body.
- At any one time, a minimum of 5 rollers are touching the floor ensuring smooth travel over cracked concrete or uneven floors.



| Product Description | L X W X H (mm) | Order Ref | Capacity (Tonnes) | Price (Each) |
|---------------------|----------------|-----------|-------------------|--------------|
| Roller Skate Kit | 206 x 100 x 77 | RSK10 | 10 | £315.00 |

Roller Crowbar

This product provides leverage when lifting heavy items/ machinery/equipment and can be used with the HDMSK or RSK10.

- Roller dimensions: W 54 x 70mmØ.
- Single piece forged steel.
- Very safe to use in all industrial areas.
- Eliminates the need to use loose tubes or bars beneath equipment to be moved.



| Product Description | L (mm) | Order Ref | Capacity (Tonnes) | Price (Each) |
|---------------------|--------|-----------|-------------------|--------------|
| Roller Crowbar | 2000 | RCK5 | 5 | £320.00 |

STEPS / ACCESS EQUIPMENT

A versatile range of mobile steps and access equipment

| Product | Lead Time (Working Days) | Page |
|---|-----------------------------|------|
| Topstep - Kick Steps | | |
| Black, Red, Blue, Dark Grey, | | |
| Light Grey, Green & Yellow | (5) | 100 |
| Topstep - Mobile Safety Steps | | |
| Step and Store | (5-7) | 101 |
| Steel Static Handy Steps | (5-7) | 101 |
| 3 Tread Step Ladders | (5-7) | 101 |
| Double Sided Loop Handle Step (2 Steps) | (5-7) | 102 |
| Tilt & Pull Steps (2, 3, & 4 Steps) | (5-7) | 102 |
| 3 Tread Platform Steps | (5-7) | 103 |
| Mobile Steps | (7-10) | 103 |
| Heavy Duty Steps (4, 6 & 8 Steps) | (7-10) | 104 |
| (5 & 7 Steps) | (10-15) | 104 |



Topstep - Kick Steps

Topstep - Kick Step is a premium GS approved quality mobile step finished in a choice of seven colours; Black, Red, Blue, Dark Grey, Light Grey, Green and Yellow.

Topstep provides easy step up access preventing excessive stretching.

The mobile step is supplied K/D where two sections permanently 'lock' together via a built-in bolt free mechanism.

- Topstep is the perfect accessory for any storeroom, office or workplace, where safe access is required for items stored at height.
- Mounted on retractable spring mounted castors Topstep can easily be moved into position without bending or lifting and when stepped on Topstep locks into position allowing safe access.
- Its sturdy steel construction with anti-slip rubber treads and base surround provide a solid platform from which to work.

Working load: 150 kgs
Overall Height: 400mm
Diameter (Top): 260mm
Diameter (Base): 430mm



| Description | RAL No. | Order Ref | Price (Each) |
|------------------------------|---------|-----------|--------------|
| Steel Kick Step - Black | RAL9005 | T1BLK | £39.00 |
| Steel Kick Step - Red | RAL3000 | T1RED | £39.00 |
| Steel Kick Step - Blue | RAL5002 | T1BLUE | £39.00 |
| Steel Kick Step - Dark Grey | RAL7012 | T1D/GREY | £39.00 |
| Steel Kick Step - Light Grey | RAL7035 | T1L/GREY | £39.00 |
| Steel Kick Step - Green | RAL6024 | T1GREEN | £39.00 |
| Steel Kick Step - Yellow | RAL1023 | T1YELLOW | £39.00 |

| BULK (40 per pallet) | |
|----------------------|--------------------|
| Order Ref | Price (per pallet) |
| T1BLK/40 | £1,391.25 |
| T1RED/40 | £1,391.25 |
| T1BLUE/40 | £1,391.25 |
| T1D/GREY/40 | £1,391.25 |
| T1L/GREY/40 | £1,391.25 |
| T1GREEN/40 | £1,391.25 |
| T1YELLOW/40 | £1,391.25 |

All pallet sizes:
 W x D x H (mm) 1200 x 1000 x 1900

Topstep - Mobile Safety Steps

Step and Store

- Step, Store and Sit, 3 in 1 step storage unit.
- Tough polypropylene construction, finished in Black and Red.
- Anti slip pads for tiled flooring.
- Working load: 150 kg

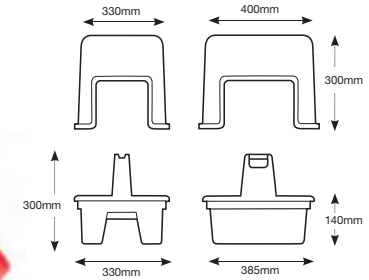

| Description | Pack Qty | Order Ref | Price (Per Pack) |
|---------------------|----------|-----------|------------------|
| Step and store unit | 8 | 008/8 | £83.32 |

Topstep - Steel Static Handy Steps

- Fitted with anti-slip rubber treads for added safety
- Powder coated in white
- Welded steel construction
- Step Size : W 380 x D 260mm
- Space between Steps : 180mm
- Working load: 150kg



| Description | H x W x D (mm) | Order Ref | Price (Each) |
|--------------------------|-----------------|-----------|--------------|
| Steel Static Handy Steps | 380 x 440 x 655 | SSHS2 | £35.31 |

Topstep - 3 Tread Step Ladders

- Foldable for easier storage
- Working load: 150kg
- Space between steps: 230mm
- Fitted with a rubber comfort handle
- Non slip tread
- Powder coated silver/grey



| Product Description | Open size H x W x D (mm) | Folding size H x W x D (mm) | Tread W x D (mm) | Order Ref | Platform Height (mm) | Price (Each) |
|----------------------|-----------------------------|--------------------------------|---------------------|-----------|-------------------------|-----------------|
| 3 Tread Step Ladders | 1065 x 490 x 665 | 1220 x 140 x 490 | 380 x 260 | SL/3 | 710 | £32.50 |

Topstep - Double Sided Loop Handle Step

Red powder coated double-sided step with loop handle and 2 x 40mm diameter nylon swivel castors.

When tilted, these steps can be pushed or pulled and the handle also enables the operator to carry the steps.

Safety grip treads are fitted as standard.



| Product Description | H x W x D (mm) | Tread W x D (mm) | Order Ref | Platform Height (mm) | Price (Each) |
|---------------------|------------------|------------------|-----------|----------------------|--------------|
| 2 step Double Sided | 1120 x 400 x 400 | 300 x 160 | DSMSS2T | 390 | £118.73 |

Topstep - Tilt and Pull Steps

Lightweight yet robust steel constructed semi-mobile steps are manufactured with two 75mm diameter rubber wheels to enable mobility when the steps are tilted.

Finished epoxy powder coated red, and, includes safety grip treads.

The 4 tread model is fitted with double handrails as standard.

Available in 2, 3, and 4 tread models.



| Product Description | Weight (kg) | H x W x D (mm) | Tread W x D (mm) | Order Ref | Platform Height (mm) | Price (Each) |
|---------------------|-------------|-------------------|------------------|-----------|----------------------|--------------|
| 2 Tread | 10 | 1050 x 470 x 630 | 400 x 200 | SMSSTP2 | 500 | £122.12 |
| 3 Tread | 12 | 1300 x 470 x 680 | 400 x 200 | SMSSTP3 | 750 | £156.04 |
| 4 Tread | 16 | 1700 x 565 x 1005 | 400 x 200 | SMSSTP4 | 1000 | £210.30 |

Topstep - 3 Tread Platform Steps

Fully mobile heavy duty 3 tread platform step with a double depth top tread for extra workspace when retrieving goods.

Epoxy powder coated in red and fitted with 4 x 75mm diameter rubber sprung swivel castors which lower to the ground under operator weight.

Double handrails are included for increased operator safety.

Safety grip treads give a durable anti-slip surface.



| Product Description | Weight (kg) | H x W x D (mm) | Tread W x D (mm) | Order Ref | Platform Height (mm) | Price (Each) |
|---------------------|-------------|------------------|------------------|-----------|----------------------|--------------|
| 3 Tread | 32 | 1560 x 670 x 750 | 550 x 200 | HDPSS3T | 690 | £271.35 |

Topstep - Mobile Steps

Mobile steps are mounted on retractable spring castors to enable the steps to be easily moved into position. When under the operator weight steps lower to grip the floor. Double handrails are included for increased operator safety.

All ribbed rubber mat treads (approx 3mm) are both glued and fastened to the steel tread to provide extra adhesion.



| Description | H x W x D (mm) | Tread W x D (mm) | Order Ref | Platform H (mm) | Platform Tread W x D (mm) | Price (Each) |
|------------------------|------------------|------------------|-----------|-----------------|---------------------------|--------------|
| Mobile Steps - 2 Tread | 1085 x 690 x 575 | 380 x 180 | LWHCS/2 | 545 | 380 x 285 | £185.00 |
| Mobile Steps - 3 Tread | 1420 x 820 x 550 | 380 x 180 | LWHCS/3 | 770 | 380 x 285 | £215.00 |
| Mobile Steps - 4 Tread | 1725 x 985 x 580 | 380 x 180 | LWHCS/4 | 1030 | 380 x 285 | £275.00 |

Topstep - Heavy Duty Steps

A range of red powder coated, fully welded, tubular framed mobile safety steps. Available in 5 heights and includes punched steel treads.

The steps have a wide base for increased stability and non-slip rubber feet are fitted to the front legs as standard.

The 4 and 5 tread models come complete with rear fixed rubber wheels and 75mm diameter rubber sprung swivel castors which lower to the ground under operators weight.

The 6 to 8 tread models include rear fixed rubber wheels and front swivel castors. These models are also fitted with a safety bar to prevent misuse of steps when mobile, and when released, this lowers the steps to the floor, thus enabling the operator to safely use the steps.

All models have a double handrail.

Other sizes and colours are available, please contact our sales department for more information.



Punched Steel Treads



4SHDMSPS

5SHDMSPS

8SHDMSPS

| Description | Castors | Wheels | Weight (kg) | H x W x D (mm) | Tread W x D (mm) | Order Ref | Platform H (mm) | Platform Tread W x D (mm) | Price (Each) |
|-------------|---------|--------|-------------|-------------------|------------------|-----------|-----------------|---------------------------|--------------|
| 4 Tread | 75mmØ | 160mmØ | 32 | 1950 x 700 x 1100 | 450 x 200 | 4SHDMSPS | 1000 | 450 x 400 | £396.70 |
| 5 Tread | 75mmØ | 160mmØ | 42 | 2150 x 700 x 1200 | 550 x 200 | 5SHDMSPS | 1250 | 550 x 400 | £516.68 |
| 6 Tread | 100mmØ | 160mmØ | 52 | 2380 x 700 x 1370 | 550 x 200 | 6SHDMSPS | 1500 | 550 x 400 | £644.45 |
| 7 Tread | 100mmØ | 200mmØ | 62 | 2610 x 700 x 1530 | 550 x 200 | 7SHDMSPS | 1750 | 550 x 400 | £763.38 |
| 8 Tread | 100mmØ | 200mmØ | 72 | 2840 x 700 x 1700 | 550 x 200 | 8SHDMSPS | 2000 | 550 x 400 | £856.26 |

WORKBENCHES

Static, mobile and semi mobile workbenches, tool trolleys and assembly benches, fully welded construction supplied assembled ready to use.

| Product | Lead Time <small>(Working Days)</small> | Page |
|---|---|-------------|
| Workbenches | (10-20) | 106 |
| Mobile Workbenches | (10-20) | 107 |
| Semi Mobile Workbenches | (10-20) | 107 |
| Workbench Accessories and Vices | (10-20) | 108 |
| Tool Trolleys | (10-20) | 108 |
| Assembly Benches | (10-20) | 109 |
| Assembly Benches Accessories. | (10-20) | 110 |



Workbenches

Heavy duty workbenches are fully welded (not flat pack) and are constructed from steel angle with braced galvanised tops or 45mm timber top or super heavy duty with galvanised steel on top of 45mm timber. Three lengths to choose from in the static bench range each available in three widths. All benches come with bottom shelf, vice plate welded underneath the front right-hand corner and cupboard included in the price. Cupboards measure 600mm x 600mm by bench depth with lock fitted as standard. Also available with extra cupboards or drawer(s) in place of the cupboard or can be fitted with five-drawer unit.



Static Workbenches (Capacity 600kg)

| L x W x H (mm) | STEEL TOP | | WOOD TOP | | WOOD & STEEL TOP | |
|------------------|-----------|--------------|-----------|--------------|------------------|--------------|
| | Order Ref | Price (Each) | Order Ref | Price (Each) | Order Ref | Price (Each) |
| 1200 x 600 x 840 | 1260SC | £330.40 | 1260WC | £357.00 | 1260WSC | £413.00 |
| 1200 x 750 x 840 | 1275SC | £344.40 | 1275WC | £371.00 | 1275WSC | £427.00 |
| 1200 x 900 x 840 | 1290SC | £358.40 | 1290WC | £385.00 | 1290WSC | £441.00 |
| 1500 x 600 x 840 | 1560SC | £350.00 | 1560WC | £385.00 | 1560WSC | £448.00 |
| 1500 x 750 x 840 | 1575SC | £364.00 | 1575WC | £399.00 | 1575WSC | £462.00 |
| 1500 x 900 x 840 | 1590SC | £378.00 | 1590WC | £413.00 | 1590WSC | £476.00 |
| 2000 x 600 x 840 | 2060SC | £399.00 | 2060WC | £441.00 | 2060WSC | £504.00 |
| 2000 x 750 x 840 | 2075SC | £413.00 | 2075WC | £455.00 | 2075WSC | £518.00 |
| 2000 x 900 x 840 | 2090SC | £427.00 | 2090WC | £469.00 | 2090WSC | £532.00 |

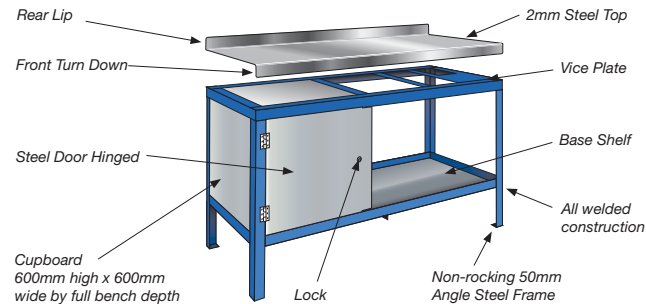

Mobile Workbenches

These fully mobile workbenches stand on four legs when in use to give maximum stability, with the wheels off the floor. Simple lever action pushes down the under-carriage and takes the weight off the legs onto the two wheels and two castors, enabling easy movement of the complete unit. Supplied with standard cupboard (SCP models) or with five drawer unit and matching cupboard (SFCP models). All models supplied with bottom shelf and vice plate. Other sizes and specification are available on request. Normal height 840mm, other heights available at no extra cost.



Semi Mobile Workbenches

These models have two wheels in permanent contact with the floor and the handle enables the four models to be pushed like a wheelbarrow. All these bench types have the cupboard under the vice plate so reducing the lifting weight.



| L x W x H (mm) | MOBILE WORK BENCHES with single cupboard | | MOBILE WORK BENCHES with 5 drawer unit & matching cupboard | | SEMI MOBILE BENCHES | |
|------------------|--|--------------|--|--------------|---------------------|--------------|
| | Order Ref | Price (Each) | Order Ref | Price (Each) | Order Ref | Price (Each) |
| 1200 x 600 x 840 | 1260SCP | £441.00 | 1260SFCP | £735.00 | 1260SCM | £350.00 |
| 1200 x 750 x 840 | 1275SCP | £455.00 | 1275SFCP | £749.00 | 1275SCM | £364.00 |
| 1500 x 600 x 840 | 1560SCP | £462.00 | 1560SFCP | £756.00 | 1560SCM | £371.00 |
| 1500 x 750 x 840 | 1575SCP | £476.00 | 1575SFCP | £770.00 | 1575SCM | £385.00 |

Workbench Accessories and Vices

Top quality engineering bench vices may be fitted to any bench if specified when ordering or supplied separately. A lockable steel drawer may be fitted to any bench as an extra or as an alternative to the cupboard.

| Description | Price (Each) |
|--|--------------|
| Extra cupboard (L x W x H: 457 x 457 x 620 mm) | £98.00 |
| Single lockable drawer (L x W x H: 457 x 457 x 150 mm) | £98.00 |
| 4" Vice (100mm) | £91.00 |
| 5" Vice (125mm) | £112.00 |
| 6" Vice (150mm) | £133.00 |



6" Vice (150mm)

Tool Trolleys

A smaller bench on four wheels (two swivel castors with brakes and two fixed castors). Constructed from the same materials as our larger benches, the tool trolley is available in four versions.



1050ST



1050SCT



1050SDCT



1050SCCT

| Description | L x W x H (mm) | Order Ref | Price (Each) |
|-------------------------------------|------------------|-----------|--------------|
| Top and base only with wheels | 1000 x 500 x 840 | 1050ST | £210.00 |
| With single cupboard with wheels | 1000 x 500 x 840 | 1050SCT | £280.00 |
| With double doors with wheels | 1000 x 500 x 840 | 1050SCCT | £364.00 |
| With two cupboards with wheels | 1000 x 500 x 840 | 1050SDCT | £364.00 |
| Top and base only without wheels | 1000 x 500 x 840 | 1050S | £182.00 |
| With single cupboard without wheels | 1000 x 500 x 840 | 1050SC | £252.00 |
| With double doors without wheels | 1000 x 500 x 840 | 1050SCC | £336.00 |
| With two cupboards without wheels | 1000 x 500 x 840 | 1050SDC | £336.00 |

Assembly Benches

Our hollow section Assembly Benches are constructed from square section steel, all joints are welded and each leg has an adjustable foot which enables the bench to be firmly seated on an uneven floor without rocking. Supplied ready to unpack and use no assembly required.

These medium duty benches are ideal for the assembly of small components especially for the electronics industry or are equally useful as packing benches. Normal height 840mm other heights available at no extra cost.

Choose from a range of different worktops - Laminate or MDF (with rounded edges), also available with steel, vinyl or anti static laminate worktop.



AB1260L



AB1575M

Shown with extra bottom shelf
(Available at additional cost)

| L x D (mm) | MDF TOP | | LAMINATE TOP | |
|-------------|-----------|--------------|--------------|--------------|
| | Order Ref | Price (Each) | Order Ref | Price (Each) |
| 1200 x 600 | AB1260M | £203.00 | AB1260L | £280.00 |
| 1200 x 750 | AB1275M | £224.00 | AB1275L | £287.00 |
| 1200 x 900 | AB1290M | £238.00 | AB1290L | £308.00 |
| 1500 x 600 | AB1560M | £231.00 | AB1560L | £301.00 |
| 1500 x 750 | AB1575M | £245.00 | AB1575L | £315.00 |
| 1500 x 900 | AB1590M | £259.00 | AB1590L | £329.00 |
| 2000 x 600 | AB2060M | £273.00 | AB2060L | £343.00 |
| 2000 x 750 | AB2075M | £287.00 | AB2075L | £357.00 |
| 2000 x 900 | AB2090M | £308.00 | AB2090L | £378.00 |
| 2000 x 1200 | AB2012M | £336.00 | AB2012L | £406.00 |

Assembly Bench Accessories

Accessories must be specified and supplied with original order as they cannot be fitted or moved subsequently.

| Description | Price (Each) |
|---|--------------|
| Single drawer (L x W x H: 457 x 457 x 150) | £98.00 |
| Cupboard unit (L x W x H: 457 x 457 x 620) | £98.00 |
| Cupboard/single drawer unit (L x W x H: 457 x 457 x 620) | £168.00 |
| Five-drawer cupboard unit (L x W x H: 457 x 457 x 620) | £287.00 |
| Bench top electrical trunking with two twin 13A sockets, 1200mm | £91.00 |
| Bench top electrical trunking with two twin 13A sockets, 1500mm | £119.00 |
| Bench top electrical trunking with two twin 13A sockets, 2000mm | £119.00 |
| Twin 13A sockets unit (island unit) | £70.00 |
| Fluorescent light fitting | £77.00 |
| Louvred Panel, 450 x 500mm | £21.00 |

| | UPPER SHELF MDF | UPPER SHELF LAMINATE | LOWER SHELF All in MDF | LIGHTING RAIL | SUPPORT BARS FOR LOUVRED PANELS |
|------------|--------------------|-------------------------|---------------------------|------------------|------------------------------------|
| L x D (mm) | Price (Each) | Price (Each) | Price (Each) | Price (Each) | Price (Each) |
| 1200 x 300 | £105.00 | £126.00 | £105.00 | £84.00 | £70.00 |
| 1500 x 300 | £112.00 | £140.00 | £112.00 | £91.00 | £84.00 |
| 2000 x 300 | £126.00 | £154.00 | £126.00 | £105.00 | £105.00 |

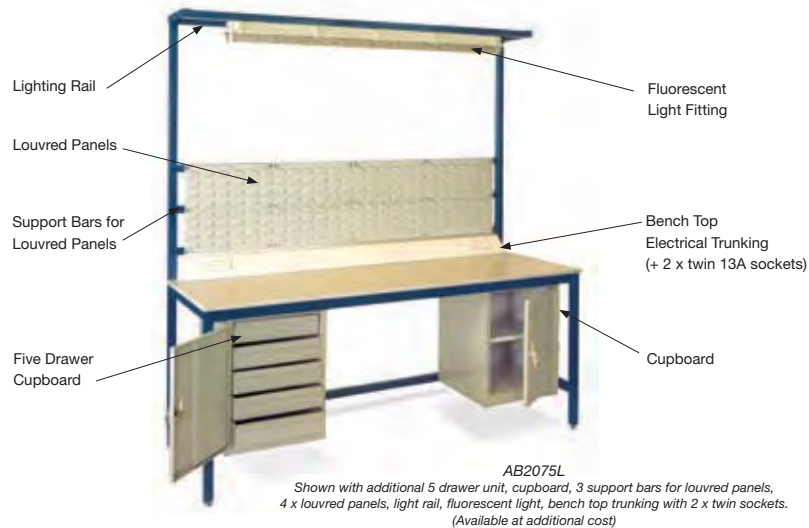

WAREHOUSE / SAFETY EQUIPMENT

Partitioning, guards and barriers for creating secure storage and safety zones.

| Product | Lead Time <small>(Working Days)</small> | Page |
|--|---|-------------|
| Topmesh - Mesh Wall Partitioning | (15-20) | 112 |
| - Machine Guard | (15-20) | 113 |
| Modular Safety Barrier System | (5-7) | 114 |
| Fork Lift Safety Cage | (10-15) | 114 |

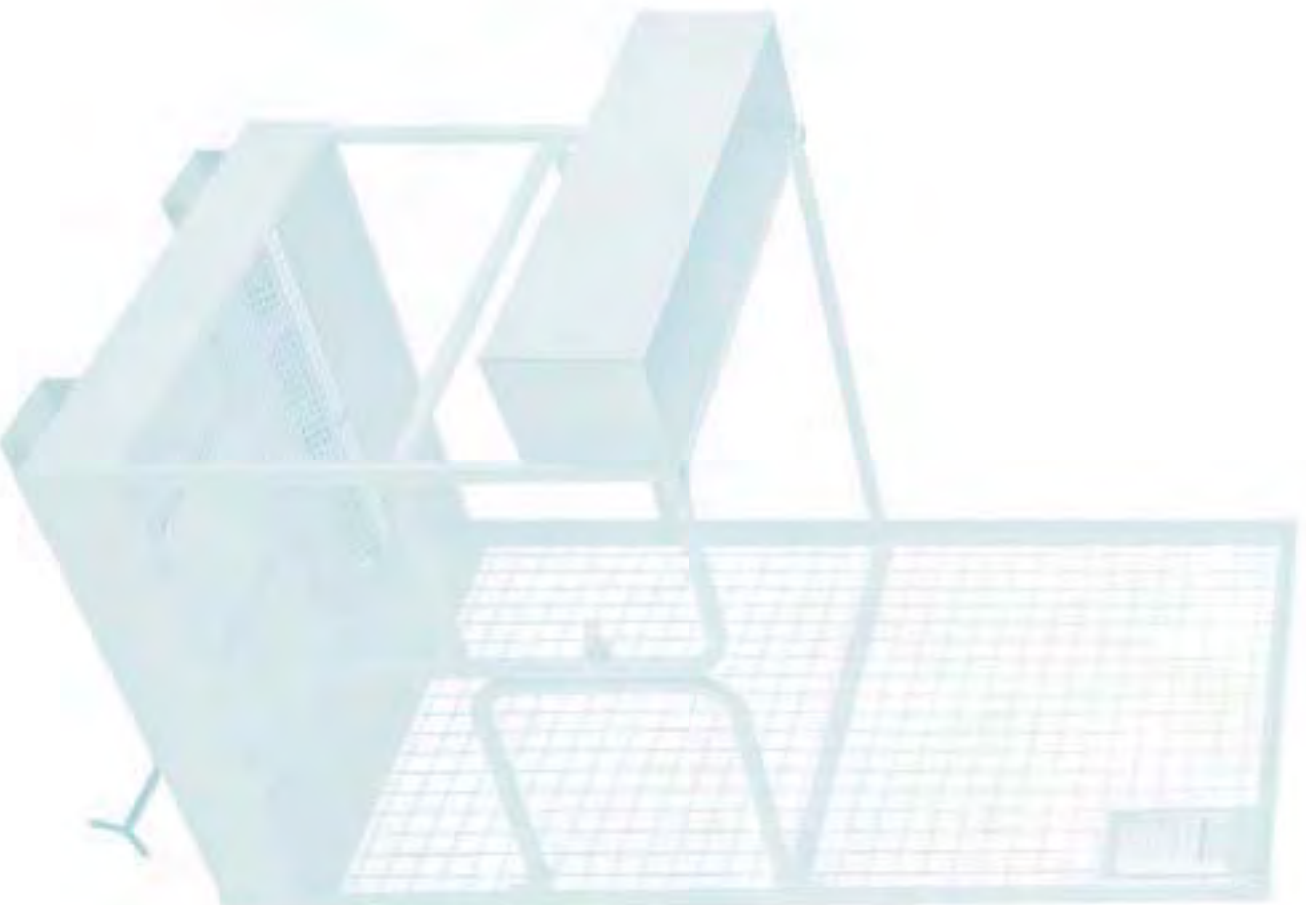

Topmesh - Mesh Wall Partitioning and Machine Guard

Topmesh - Mesh Wall Partitioning

Mesh wall partitioning is ideal for creating secure locations such as archive, quarantine and storage areas where restricted access is required. Alternatively create dividing walls, barriers and mesh roofs whilst enabling full visibility at all times.

Prefabricated mesh panels offer an easy solution to the problem of revised working or warehouse reorganisation, whilst giving scope and flexibility for future expansion. The partitioning is supplied as a standard height of 2200mm, however virtually any height can be achieved. It is the practical economical solution to providing an enclosure and/or dividing screen for goods and machinery.

Security

The unique design of the floor fixing and the method in which panels are fitted together ensures the system cannot be dismantled from the outside of the enclosure.

Doors

All Doors are manufactured with a rigid steel framework to provide a strength and durability, available in single or double opening as hinged or sliding options. All doors can be fitted with a hasp and staple (for padlock) or a cylinder lock.

Features:

- Easy to customise – the panel sections are available in 9 sizes, thus saving material and installation time.
- Stable design, 30mm vertical sections, five horizontal tube reinforcements per mesh section.
- Strong 60 x 60mm posts that includes a base, to enable floor fixing.
- Scratch and impact-resistant surface, welded Galvanised coated material, which provides a degree of anti-rust protection.
- Allows air, light and water to pass through.

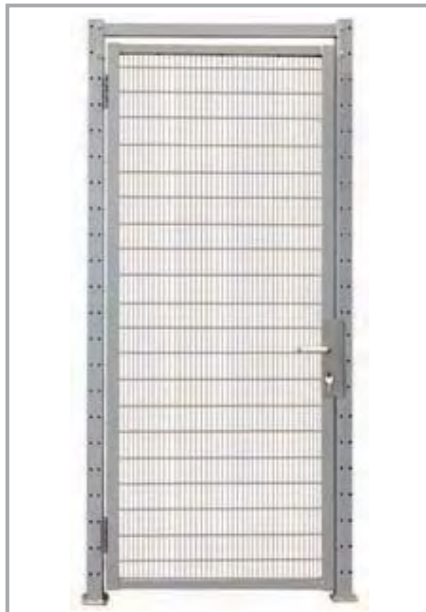

Topmesh - Machine Guard

Topmesh Machine Guard is an accident prevention system which protects personnel from injury or damage to expensive plant and equipment when positioned around machines, robots, conveyors, lifts etc.

Modular, flexible and easy to install. Hinged and sliding door options are available, with each package comprising all the necessary fixings and accessories which include a fitted handle with either a hasp and staple or cylinder lock.

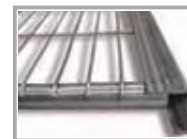

Mesh Panel Specification

| | |
|----------------|-------------------|
| Mesh Spacing : | 18 x 97mm |
| Uprights : | 30 x 25mm |
| Horizontals : | Ø19mm |
| Wires : | Ø2.5mm and Ø3.0mm |
| Finish : | Galvanised |

Note: Please contact our projects department for specific requirements.

Modular Safety Barrier System

Features:

- A highly visible safety barrier system designed for creating pedestrian walkways, dividing manufacturing units, stock areas, warehouse and commercial premises where for safety and other reasons segregation is required.
- Designed to be sited as individual units or in long runs.
- Supplied in KD form complete with fixing instructions.
- Posts are drilled through 4 sides to enable barriers to be positioned in straight runs or through 90 degrees.
- Ready for use, with the base plates conveniently pre-drilled for easy surface fixing. (Please note floor fixings are not included).
- Finished in epoxy powder coated bright yellow.



| Product Description | H x W x D (mm) | Order Ref | Price (Each) |
|--------------------------|------------------|-----------|--------------|
| Safety Barrier Initial | 1000 x 1000 x 50 | MSBSI | £155.00 |
| Safety Barrier Extension | 1000 x 950 x 50 | MSBSE | £120.00 |

Fork Lift Safety Cage

Features:

- Designed to provide safe working access to inaccessible places, accommodating two people plus their tools and equipment.
- Manufactured according to Health and Safety guidance note PM28 (3rd Edition) Dec. 2005.
- Approved to be used by 2 persons of average weight.
- Fully welded with a raised expanded metal floor, located and welded into a formed kickboard surround.
- Tubular Handrail.
- Rear RSA frame with wire mesh panels. Hinged entry gate with spring return to closed position.
- Spring loaded retention bolt holds the gate in the closed position).
- Supplied with a tool box.



Tool box



Fork Pocket General Specification:
 (W) 184 x (D) 83mm, with inside clearance 545mm and overall clearance 921mm.

Note: Fork Pocket specification can be altered to meet customers' requirements. Please specify when ordering otherwise the above dimensions will apply.

| Product Description | Hand Rail H (mm) | Platform W X L (mm) | Weight (kgs) | Order Ref | Max Load (kgs) | Price (Each) |
|-----------------------|------------------|---------------------|--------------|-----------|----------------|--------------|
| Fork Lift Safety Cage | 1040 | 990 x 990 | 70 | FLSC | 250 | £895.00 |