



# Infrared temperature measuring instrument

**testo 830 – Fast, non-contact measurement of surface temperature**



---

Laser measurement point marker and large optics for exact measurement even at greater distances

---

Fast recording of measurement values at two measurements per second

---

Adjustable emissivity

---

Two adjustable alarm limit values

---

Good handling thanks to ergonomic "pistol design"

---

Hold function and display of min./max. values

---

The testo 830 is a universally applicable infrared thermometer for non-contact measurement of surface temperatures in trade and industry. Thanks to a new processor, and therefore better resolution, even more precise measurements are now possible. Temperature can now be recorded to an accuracy of 0.1 °C. Thanks to the min./max. function, the limit values of the last measurement can be displayed and even better monitored.

The testo 830 infrared thermometer in brief:

**testo 830-T1** with 1-point laser measurement spot marking and 10:1 optics.

**testo 830-T2** with 2-point laser measurement spot marking and 12:1 optics.

**testo 830-T4** with 2-point laser measurement spot marking and 30:1 optics. This instrument measures the surface temperature even of smaller objects at a safe distance.

External temperature probes can be connected.

# Infrared temperature measuring instruments

## testo 830

### Infrared thermometer with 1-point laser sighting

#### testo 830-T1

testo 830-T1, infrared thermometer, 1 point laser sighting, 10:1 optics, adjustable limit values, alarm function, incl. Batteries and factory calibration certificate

Part no. 0560 8311

**£ 84.32**



### Infrared thermometer with 2-point laser sighting and connection for external probes

#### testo 830-T2

testo 830-T2, infrared thermometer, 2-point laser sighting, 12:1 optics, adjustable limit values, alarm function, connection of external probes, incl. Batteries and factory calibration certificate

Part no. 0560 8312

**£ 105.00**



The fast and universal infrared thermometer with 1-point laser sighting and 10:1 optics in ergonomic "pistol design".

- Fast readings
- Laser sighting
- Adjustable alarm limits
- Audible and visual alarm if limits are exceeded
- User-friendly thanks to "pistol design"
- Backlit display
- Adjustable emission factor (0.1 to 1.0)

#### testo 830-T2 Set

Set testo 830-T2, infrared thermometer with protective leather case, incl. cross-band surface probe (0602 0393), Batteries and factory calibration certificate

Part no. 0563 8312

**£ 172.00**

This universal infrared thermometer is designed to perform fast and accurate surface temperature measurements in the HVAC area and industry. The new high resolution processor enables measurement results of unbelievable accuracy. Thanks to the min./max. function you can define your temperature limit values according to your needs. To control the limits with the help of an audible and visual alarm has never been easier.

In addition to the benefits of testo 830-T1:

- 2-point laser sighting
- Contact measurement with connectable temperature probe
- Emissivity determination with external TC probe

# Infrared temperature measuring instruments

## testo 830

Infrared thermometer with 30:1 optics for exact measurement at a distance

### testo 830-T4

testo 830-T4, infrared thermometer, 2-point laser sighting, 30:1 optic, adjustable limit values, alarm function, connection of external probes, incl. Batteries and factory calibration certificate

Part no. 0560 8314

£ 158.00



### Set testo 830-T4

Set testo 830-T4, infrared thermometer with protective leather case, incl. cross-band surface probe (0602 0393), battery and factory calibration certificate

Part no. 0563 8314

£ 214.00

This universal infrared thermometer is designed to perform fast and accurate surface temperature measurements in the HVAC area and industry. At a distance of 1 m the point diameter is only 3.6 cm. From a secure distance even smaller, difficult to access or dangerous targets can be measured without any problems. The new high resolution processor enables measurement results of unbelievable accuracy. And due to the min./max. function you can define your temperature limit values according to your needs. To control the limits with the help of an audible and visual alarm has never been easier.

- 30:1 optics for measuring temperature at a distance, even on small objects
- °C contact measurement with connectable TC probe
- Emissivity determination with external temperature probe
- Input of upper and lower limit value
- Audible and optical alarm when limit values are exceeded
- Display illumination

## Technical data

### Common technical data for all versions

Spectral range	8 to 14 $\mu\text{m}$	Battery type	9V block battery
Emissivity	Adjustable 0.1 to 1.0	Battery life	15 h
Storage temperature	-40 to +70 $^{\circ}\text{C}$	Weight	200 g
Operating temperature	-20 to +50 $^{\circ}\text{C}$	Dimensions	190 x 75 x 38 mm
Warranty	2 years	Housing material	ABS

### Varying technical data

	testo 830-T1	testo 830-T2	testo 830-T4
<b>Meas. range</b>			
Infrared	-30 to +400 $^{\circ}\text{C}$	-30 to +400 $^{\circ}\text{C}$	-30 to +400 $^{\circ}\text{C}$
Type K (NiCr-Ni)	-	-50 to +500 $^{\circ}\text{C}$	-50 to +500 $^{\circ}\text{C}$
<b>Accuracy <math>\pm 1</math> digit</b>			
Infrared	$\pm 1.5^{\circ}\text{C}$ or 1.5 % of mv (+0.1 to +400 $^{\circ}\text{C}$ ) $\pm 2^{\circ}\text{C}$ or $\pm 2$ % of mv (-30 to 0 $^{\circ}\text{C}$ ) the higher value applies	$\pm 1.5^{\circ}\text{C}$ or $\pm 1.5$ % of mv (+0.1 to +400 $^{\circ}\text{C}$ ) $\pm 2^{\circ}\text{C}$ or $\pm 2$ % of mv (-30 to 0 $^{\circ}\text{C}$ ) the higher value applies	$\pm 1.5^{\circ}\text{C}$ (-20 to 0 $^{\circ}\text{C}$ ) $\pm 2^{\circ}\text{C}$ (-30 to -20,1 $^{\circ}\text{C}$ ) $\pm 1^{\circ}\text{C}$ or 1 % of mv (remaining range)
Type K (NiCr-Ni)	-	$\pm 0.5^{\circ}\text{C}$ +0.5% of mv	$\pm 0.5^{\circ}\text{C}$ +0.5% of mv
<b>Resolution</b>	0.1 $^{\circ}\text{C}$	0.1 $^{\circ}\text{C}$	0.1 $^{\circ}\text{C}$
<b>Measurement rate</b>			
Infrared	0.5 s	0.5 s	0,5 s
Type K (NiCr-Ni)	-	1.75 s	1.75 s
<b>Meas. spot marking</b>	1-point laser	2-point laser	2-point laser
<b>Distance to measurement spot</b>	10:1	12:1	30:1 (typical at a distance of 0.7 m to the measurement object 24 mm @ 700 mm (90%))

# Optics

## testo 830-T1

10:1 standard optics,  
1 laser beam for spot sighting

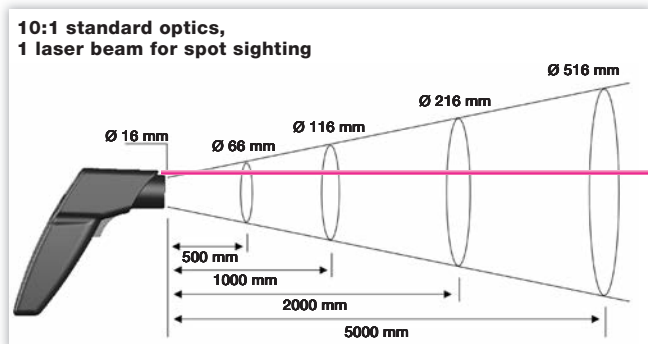

## testo 830-T2

Accurate 12:1 optics enable accurate measurements over great distances, 2 laser beams for sighting

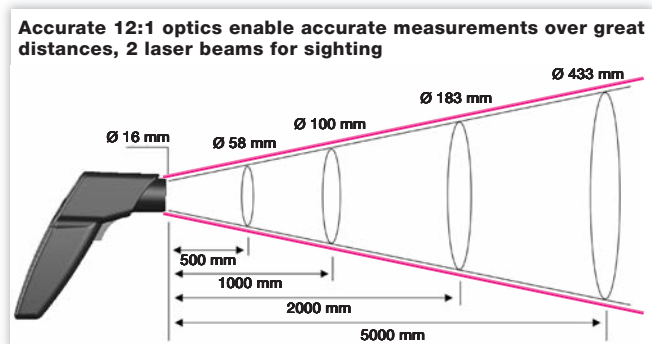

## testo 830-T4



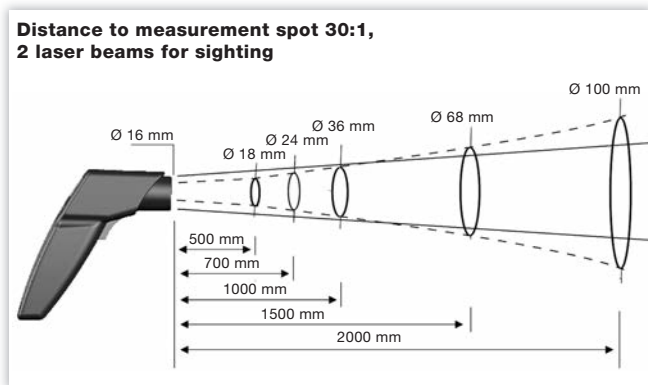

Distance to measurement spot 30:1,  
2 laser beams for sighting



# Accessories

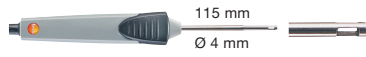

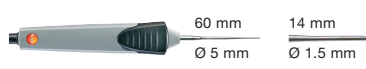
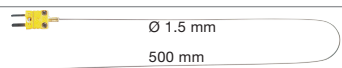
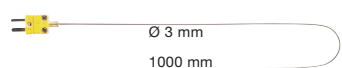
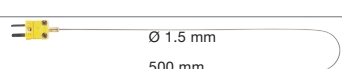
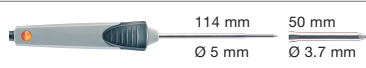
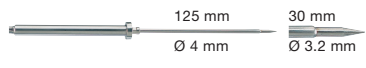

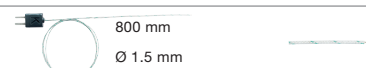
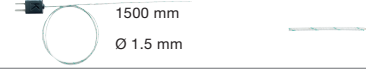
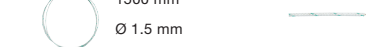

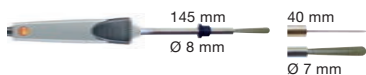
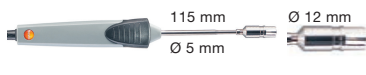
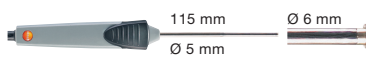

Accessories for all testo 830 versions	Part no.	£
Adhesive tape, e.g. for bare surfaces (roll, L.: 10 m, W.: 25 mm), $\epsilon = 0.95$ , temperature resistant to +250 °C	0554 0051	<b>73.92</b>
Leather case to protect measuring instrument, including belt holder	0516 8302	<b>11.03</b>
9V rech. battery for instrument, instead of battery	0515 0025	<b>27.72</b>
Recharger for 9V rechargeable battery, for external recharging of 0515 0025 battery	0554 0025	<b>28.04</b>
ISO calibration certificate/temperature, infrared thermometer; calibration points +60°C; +120°C; +180°C	0520 0002	<b>151.16</b>
<b>Accessories for testo 830-T2 / -T4</b>		
ISO calibration certificate/temperature, meas. instr. with surface probe; calibration points +60°C; +120°C; +180°C	0520 0071	<b>162.74</b>
ISO calibration certificate/temperature, for air/immersion probes, calibration point +60°C	0520 0063	<b>64.78</b>
ISO calibration certificate/temperature, for air/immersion probes, calibration points -18°C; 0°C; +60°C	0520 0001	<b>122.37</b>
ISO calibration certificate/temperature, meas. instr. with air/immersion probe; cal. points 0°C; +150°C; +300°C (Applies only to immersion/penetration probe 0602 2693)	0520 0021	<b>155.54</b>

# Probes testo 830-T2 / -T4

Probe type	Dimensions Probe shaft/probe shaft tip	Measuring range	Accuracy	t <sub>99</sub>	Part no. £
<b>Air probes</b>					
Robust air probe, T/C Type K, Fixed cable 1.2 m	 115 mm Ø 4 mm	-60 to +400 °C	Class 2*	25 s	0602 1793  <b>47.83</b>
<b>Immers./penetr. probes</b>					
Efficient and fast-action immersion probe, waterproof, TC Type K, Fixed cable 1.2 m	 300 mm Ø 1.5 mm	-60 to +1000 °C	Class 1*	2 s	0602 0593  <b>81.00</b>
Fast-action, waterproof immersion/penetration probe, TC Type K (Calibration not possible over +300 °C), Fixed cable 1.2 m	 60 mm 14 mm Ø 5 mm Ø 1.5 mm	-60 to +800 °C	Class 1*	3 s	0602 2693  <b>101.00</b>
Immersion tip, flexible, TC Type K	 Ø 1.5 mm 500 mm	-200 to +1000 °C	Class 1*	5 s	0602 5792  <b>30.77</b>
Immersion measurement tip, flexible, for measurements in air/exhaust gases (not suitable for measurements in smelters), TC Type K	 Ø 3 mm 1000 mm	-200 to +1300 °C	Class 1*	4 s	0602 5693  <b>39.06</b>
Immersion tip, flexible, TC Type K	 Ø 1.5 mm 500 mm	-200 to +40 °C	Class 3*	5 s	0602 5793  <b>31.40</b>
Waterproof immersion/penetration probe, TC Type K, Fixed cable 1.2 m	 114 mm 50 mm Ø 5 mm Ø 3.7 mm	-60 to +400 °C	Class 2*	7 s	0602 1293  <b>32.55</b>
<b>Food probes</b>					
Waterproof food probe made of stainless steel (IP65), TC Type K, Fixed cable	 125 mm 30 mm Ø 4 mm Ø 3.2 mm	-60 to +400 °C	Class 2*	7 s	0602 2292  <b>95.13</b>
Waterproof robust immersion/penetration probe with metal protection hose Tmax +230 °C, e.g. for monitoring temp. in cooking oil, T/C Type K, Fixed cable	 240 mm Ø 4 mm	-50 to +230 °C	Class 1*	15 s	0628 1292  <b>73.71</b>
<b>Thermocouples</b>					
Thermocouple with TC adapter, flexible, 800 mm long, fibre glass, TC Type K	 800 mm Ø 1.5 mm	-50 to +400 °C	Class 2*	5 s	0602 0644  <b>18.19</b>
Thermocouple with TC adapter, flexible, length 1500 mm , fibreglass, TC Type K	 1500 mm Ø 1.5 mm	-50 to +400 °C	Class 2*	5 s	0602 0645  <b>32.10</b>
Thermocouple with TC adapter, flexible, 1500 mm long, PTFE, TC Type K	 1500 mm Ø 1.5 mm	-50 to +250 °C	Class 2*	5 s	0602 0646  <b>32.10</b>

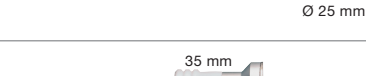
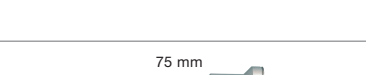
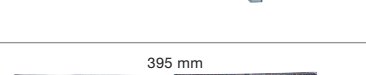
\*According to standard EN 60584-2, the accuracy of Class 1 refers to -40 to +1000 °C (Type K), Class 2 to -40 to +1200 °C (Type K), Class 3 to -200 to +40 °C (Type K)

## Probes testo 830-T2 / -T4

Probe type	Dimensions Probe shaft/probe shaft tip	Measuring range	Accuracy	t <sub>99</sub>	Part no. £
<b>Surface probes</b>					
Fast-reaction paddle surface probe, for measurements in inaccessible places, e.g. narrow apertures and slots, TC Type K, Fixed cable		0 to +300 °C	Class 2*	5 s	0602 0193 <b>105.00</b>
Fast-action surface probe with sprung thermocouple strip, also for uneven surfaces, measurement range short-term to +500°C, TC Type K, Fixed cable 1.2 m		-60 to +300 °C	Class 2*	3 s	0602 0393 <b>98.39</b>
Waterproof surface probe with widened measurement tip for flat surfaces, T/C Type K, Fixed cable 1.2 m		-60 to +400 °C	Class 2*	30 s	0602 1993 <b>46.94</b>
Fast-action surface probe with sprung thermocouple strip, bent, also for uneven surfaces, measurement range short-term to +500°C, TC Type K, Fixed cable 1.2 m		-60 to +300 °C	Class 2*	3 s	0602 0993 <b>120.00</b>
Efficient, waterproof surface probe with small measurement head for flat surfaces, TC Type K, Fixed cable 1.2 m		-60 to +1000 °C	Class 1*	20 s	0602 0693 <b>89.25</b>
Flat head surface probe with telescopic handle max. 680 mm for measurements at hard-to-access points, TC Type K, Fixed cable, 1.6 m (correspondingly shorter when telescope extended)		-50 to +250 °C	Class 2*	3 s	0602 2394 <b>272.00</b>
Magnetic probe, adhesive force approx. 20 N, with magnets, for measurements on metal surfaces, TC Type K, Fixed cable		-50 to +170 °C	Class 2*	150 s	0602 4792 <b>192.00</b>
Magnetic probe, adhesive force approx. 10 N, with magnets, for higher temp., for measurements on metal surfaces, TC Type K, Fixed cable		-50 to +400 °C	Class 2*		0602 4892 <b>204.00</b>
Pipe wrap probe with velcro strip; for temperature measurement on pipes with diameter up to max. 120 mm; Tmax. +120 °C; TC Type K, Fixed cable		-50 to +120 °C	Class 1*	90 s	0628 0020 <b>44.73</b>
Pipe wrap probe for pipe diameter 5 to 65 mm, with exchangeable measuring head. Meas. range short-term up to +280°C, TC Type K, Fixed cable		-60 to +130 °C	Class 2*	5 s	0602 4592 <b>123.00</b>
Spare meas. head for pipe wrap probe, TC Type K		-60 to +130 °C	Class 2*	5 s	0602 0092 <b>41.58</b>
Clamp probe for measurements on pipes, pipe diameter 15 to 25 mm (max. 1"), meas. range short-term up to +130°C, TC Type K, Fixed cable		-50 to +100 °C	Class 2*	5 s	0602 4692 <b>52.29</b>

\*According to standard EN 60584-2, the accuracy of Class 1 refers to -40 to +1000 °C (Type K), Class 2 to -40 to +1200 °C (Type K), Class 3 to -200 to +40 °C (Type K)

0981 9371 20/cw/A/01.2014

Subject to change without notice.  
All prices are net and valid until 31.12.2014.  
Shipping costs & VAT not included.



**Testo Limited**  
Newman Lane  
ALTON, HAMPSHIRE  
GU34 2UR  
Phone: 01420 544 433  
Fax: 01420 544 434  
Email: [info@testo.co.uk](mailto:info@testo.co.uk)