

The SHK manual chain hoist

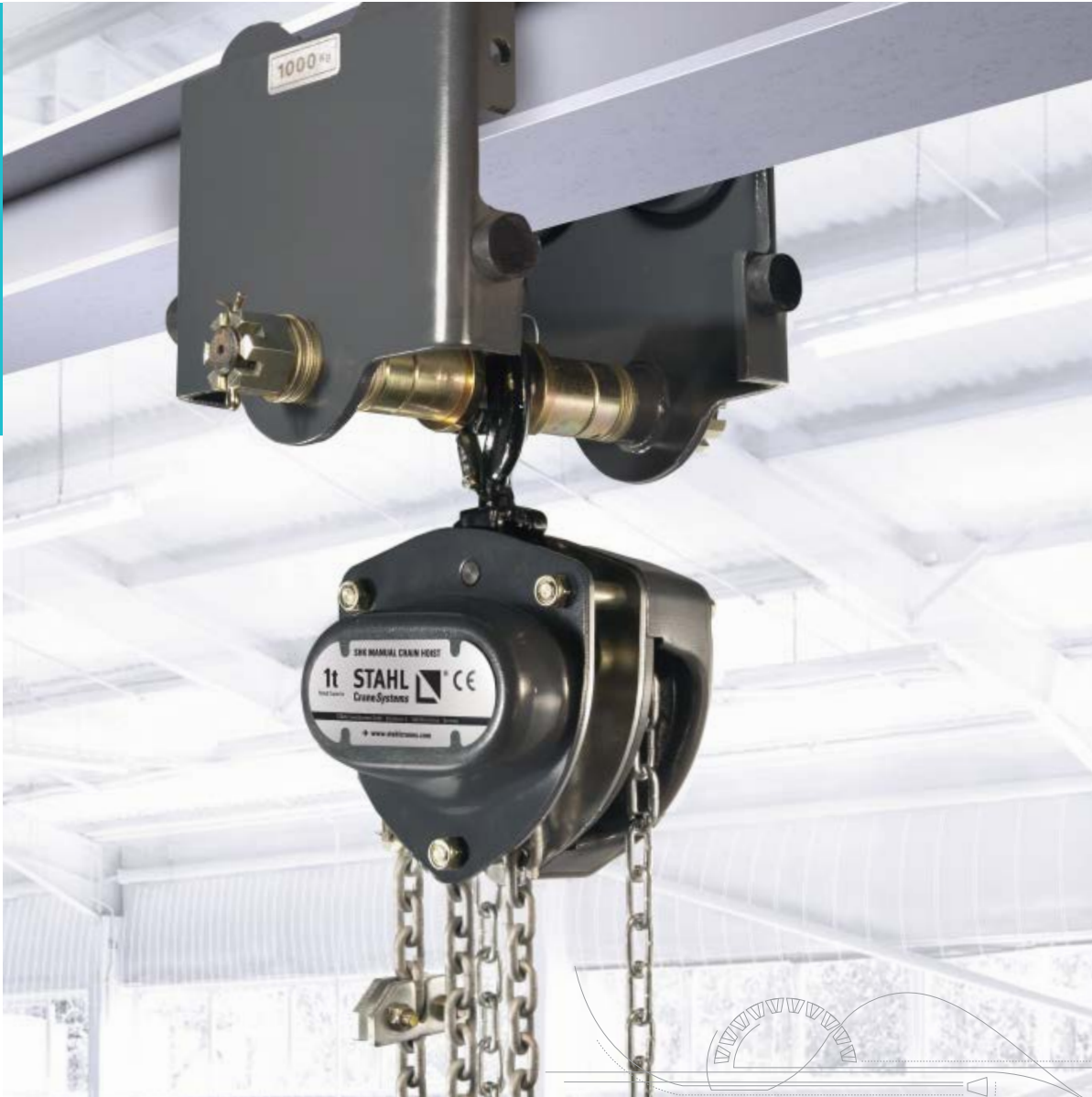

10.2016

Partner of Experts

STAHL
CraneSystems 

The SHK and SHK+ manual chain hoist



The SHK manual chain hoist features a wide spectrum of applications, independent of a power supply. The robust, compact construction allows optimum use of the available space. Thanks to its low deadweight it is ideally suited for flexible use or rapid changes of location. Simple, ergonomic manual operation combined with a high level of operating safety distinguish this manual chain hoist.

The high-quality SHK manual chain hoist from STAHL CraneSystems is designed for the lifting capacity range from 250 kg to 5,000 kg. It can be used as a stationary hoist with suspension hook or eye or beam clamps, or with various trolleys. An extremely short headroom is achieved with rigid suspension in combination with the SIHK trolley.

The SHK+ manual chain hoist from STAHL CraneSystems, almost identical in construction, is available for the upper lifting capacity range from 500 kg to 20,000 kg. Thanks to its special surface coating it is also suitable for rugged offshore use.



The facts

- Robust manual chain hoist for the lifting capacity range from 250 kg to 20,000 kg
- Steel gear housing and handwheel cover
- Powder coated in RAL 7021, dry film thickness 70 µm on SHK, dry film thickness 180 µm on SHK+ (offshore quality)
- Zinc-coated high-tensile load chain of alloyed steel
- Stainless steel chain as an option
- Powerful and smooth-running thanks to milled chain sprocket and gearwheels
- SHK+ chain sprocket with additional ball bearing
- Slipping clutch as overload device on SHK+
- Weston-style brake, double pawls, two friction discs, four braking surfaces

➔ For detailed information on the whole product programme please download our Product Information Brochure on manual chain hoists from the download area of our website.

The SHKex explosion-protected manual chain hoist



STAHL CraneSystems is recognised internationally as an explosion protection specialist and is a world market leader in explosion protection technology. The safety of people and machines in areas exposed to gas and dust explosion hazards is our top priority. Here we make no compromises. Hoisting technology from STAHL CraneSystems ranks among the safest technology on the market in the petrochemical and pharmaceutical industries, the food processing industry, power supply, shipbuilding, offshore and natural gas liquefaction (LNG) industries.

The SHKex manual chain hoist is based on the SHK+ manual chain hoist. Thanks to its special features it can be used in areas exposed to gas or dust explosion hazards, explosion protection Zone 1, Zone 2, Zone 21 and Zone 22. The strict ATEX directives on mechanical and electrical explosion protection are of course met.



The facts

- Robust SHKex manual chain hoist for the lifting capacity range from 500 kg to 20,000 kg
 - Based on the SHK/SHK+ manual chain hoist
 - Aluminium powder coating, RAL 9006, dry film thickness 70 µm
 - Stainless steel hand chain (316L)
 - Bronze-coated hook, brass-copper-zinc alloy (CuZn36 or CuZn39Pb2), dry film thickness 60 µm
 - Suitable for Zone 1, Zone 2, Zone 21 and Zone 22
 - Designed in compliance with ATEX in certified quality
 - All manual trolleys also available in explosion-protected design
- For more information, visit www.stahlcranes.com or ask for our brochure "Expertise in explosion protection", which we will gladly send to you by post.



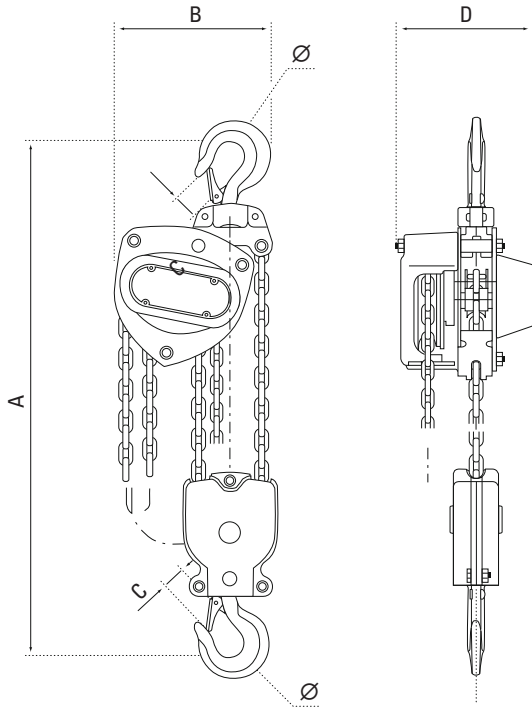

Optional manual hoist

SLP lever hoist



- For lifting, pulling and tensioning
- Robust chrome-plated steel design
- Enclosed brake, two friction discs with four braking surfaces
- Rubber-handled lever, rotatable by 360°
- ISO steel hook, heat-treated, hook safety latch, check points

| Type | Lifting capacity | Falls | Chain | A | B | C | D | Ø | Lifting height with push trolley | Force to lift rated load | Weight with 3 m lifting height | Additional weight per 1 m lifting height |
|---------------|------------------|-------|---------|-----|-----|------|-----|-----|----------------------------------|--------------------------|--------------------------------|--|
| | [kg] | | [mm] | | | [mm] | | | [mm] | [N] | [kg] | [kg] |
| SHK | 250 | 1 | 4 x 12 | 280 | 121 | 21 | 114 | 31 | 340 | 235 | 6.5 | 0.4 |
| | 500 | 1 | 5 x 15 | 345 | 148 | 23 | 132 | 35 | 407 | 240 | 9.3 | 0.6 |
| | 1,000 | 1 | 6 x 18 | 376 | 172 | 27 | 151 | 40 | 457 | 250 | 12.2 | 0.8 |
| | 1,500 | 1 | 7 x 21 | 442 | 196 | 33 | 173 | 45 | 538 | 265 | 16.5 | 1.1 |
| | 2,000 | 1 | 8 x 24 | 470 | 210 | 35 | 175 | 50 | 566 | 335 | 19.5 | 1.4 |
| | 3,000 | 1 | 10 x 28 | 548 | 255 | 39 | 205 | 55 | 688 | 372 | 32.0 | 2.2 |
| | 5,000 | 2 | 9 x 27 | 688 | 280 | 45 | 189 | 65 | 849 | 360 | 41.3 | 3.6 |
| | 7,500 | 3 | 9 x 27 | 690 | 433 | 54 | 189 | 75 | 866 | 380 | 62.0 | 5.4 |
| | 10,000 | 4 | 9 x 27 | 765 | 433 | 54 | 189 | 75 | 952 | 380 | 78.5 | 7.2 |
| | 12,500 | 5 | 9 x 27 | 835 | 430 | 54 | 220 | 75 | 1,022 | 380 | 110.0 | 9.0 |
| SHK+ SHKex | 16,000 | 2 x 3 | 9 x 27 | 900 | 718 | 71 | 200 | 95 | 1,183 | 380 | 135.5 | 10.8 |
| | 20,000 | 2 x 4 | 9 x 27 | 950 | 840 | 85 | 200 | 106 | 1,228 | 380 | 192.0 | 14.4 |

The configurations and trolley versions

In standard version, the manual chain hoists are equipped with hook suspension. They are used either as stationary hoists with or without beam clamps or with SRF, SHP or SIHK manual trolleys.

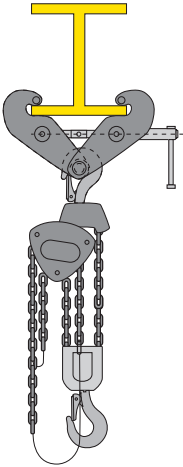

SK beam clamp

The beam clamp can be adjusted to a wide selection of beam widths. Mounting by means of the spindle mechanism with locking bolt is safe and easy. The bolt for mounting the manual hoist is integrated into the clamp, providing a conveniently low headroom.

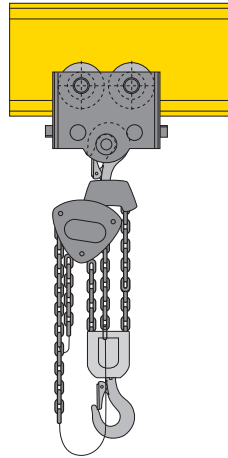

SRF manual trolley

The SRF manual trolley is designed for manual hoists or electric chain hoists with hook suspension and for a lifting capacity of up to 10,000 kg. It is moved by pushing the load. Adjusting it to the different flange widths up to 300 mm could not be simpler. Crowned wheels are used for all types of profile. Machined steel flanged wheels ensure smoother running. The roller bearings in the wheels are sealed on both sides and thus maintenance-free. The SRF manual trolley is supplied complete with fall arresters and rubber buffers. It can be designed for higher lifting capacities and flange widths above 300 mm on request. In addition, it is also available in explosion-protected design complying with ATEX.

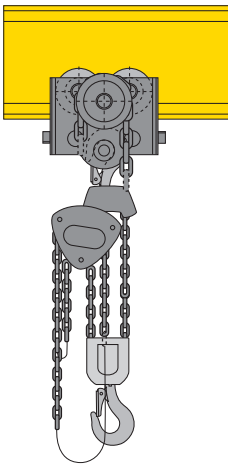

SHP manual trolley

The SHP manual trolley is designed for manual hoists or electric chain hoists with hook suspension and for a lifting capacity up to 20,000 kg. Construction and function are identical to the SRF manual trolley. However in this case the load is moved by pulling on the zinc-coated hand chain. The SHP manual trolley is also available in explosion-protected design complying with ATEX.

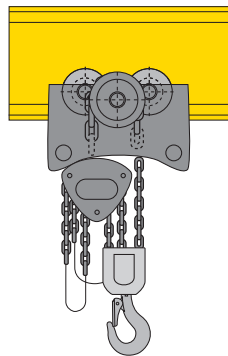

SIHK manual trolley

The SIHK short headroom manual trolley is designed for the rigid attachment of SHK and SHK+ manual chain hoists and is supplied ready mounted with fall arresters and rubber buffers. It is designed for a lifting capacity up to 20,000 kg. Here too adjusting to the different flange widths up to 300 mm could not be easier. The SIHK manual trolley is moved by a reel chain drive with zinc-coated hand chain. It can be designed for higher lifting capacities and flange widths above 300 mm on request. In addition, it is also available in explosion-protected design complying with ATEX.



Argentina Australia Austria Belgium Brazil Canada Chile **China** Columbia Croatia Czech Republic
Denmark Ecuador Egypt Estonia Finland **France** Germany **Great Britain** Greece Hongkong Hungary **India** Indonesia

Ireland Israel Italy Jordan Latvia Lebanon Lithuania Malaysia Mexico
Netherlands Nigeria Norway Pakistan Peru Philippines Poland **Portugal** Rumania Russia

Singapore Slovakia Slovenia South Africa South Korea **Spain** Sweden Syria
Taiwan Thailand Turkey **UAE** Uruguay **USA** Venezuela Vietnam

Sales partners **Subsidiaries**

You can find this and other brochures at www.stahlcranes.com/download. We will gladly also send them to you by post.

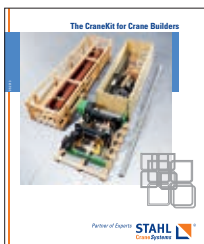
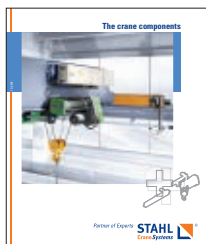
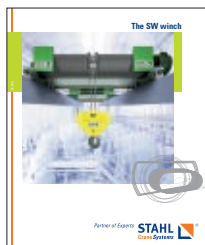
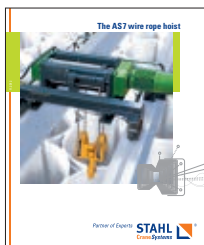
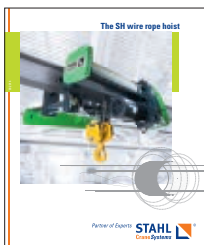

Presented by

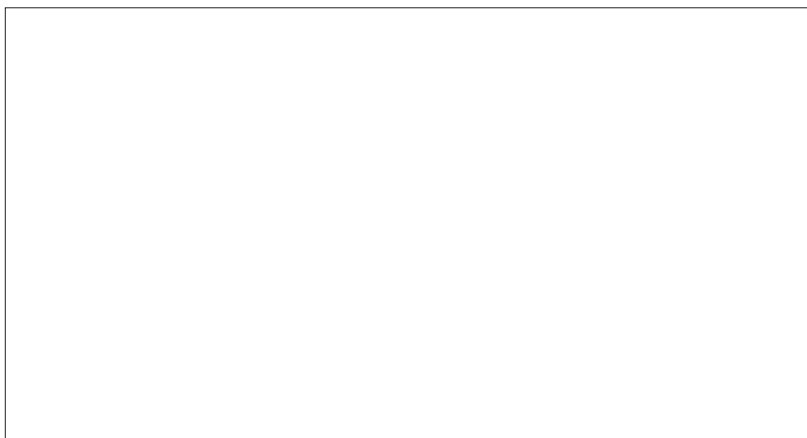

➔ www.stahlcranes.com

STAHL CraneSystems GmbH
Daimlerstr. 6, 74653 Künzelsau, Germany
Tel +49 7940 128-0, Fax +49 7940 55665
marketing.scs@stahlcranes.com

Partner of Experts



All specifications and illustrations are non-binding. Subject to modification, errors and printing errors excepted. Printed in Germany. Sach-Nr. 990 141 0 F-PB-1.7-EN-10.16-vis visuell.de