

Total Cubicle Solutions

Rainbow Range

Cubicles • Vanity Units • IPS Units • Digital Print



Rainbow Range

Introducing a new dimension in washrooms.

When you require a solution that just works, Rainbow provides the answer, being one of the most popular and well established ranges that we offer. It is specifically designed for children, from nursery right through to junior school age and has, over the years, been tailored to ensure it creates a safe, hygienic and bright washroom environment for children.

Using vibrant colours with contrasting edges, with the added options of multi-coloured hardware and our bespoke screen printing service which offers a collection of bright and inventive designs for children, we can help you to re-invent your washroom area and turn it into a bright, clean and exciting environment for children.

Should you wish to add a personal touch, we can also encompass your own design or motifs within our cubicles to give you a truly unique washroom.

Rainbow offers specifically shaped and sized doors and partitions to ensure children receive all the privacy they require, while maintaining a suitable level of supervision for their safety. If required, Rainbow is also available with ambulant sized access to ensure compliance with the Building Regulations part M. Rainbow also offers IPS panels, Vanity Units and Wall Clad systems to suit.

Total Cubicle Solutions take pride in providing a personalised, professional and cost effective service and can offer a fast turnaround for the tightest of deadlines and having built up a reputation for superb after sales support, our goal is to supply your cubicles with the minimum of fuss, ensuring that from the start to finish, your project runs smoothly.

All this, and the added reassurance that you are dealing with people with over 75 years experience in the industry.



Units 5-7, Luton Street
Liverpool
L5 9XR

T: 0844 800 7785
F: 0844 800 7738
E: sales@totalcubicles.co.uk



Toilet Cubicle Layout Options

Single Cubicle (SI)

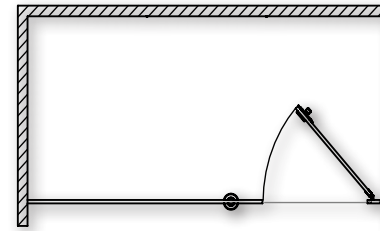

Free Standing (FS)

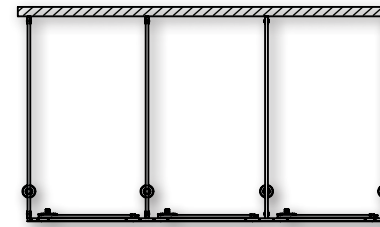

Open Ended (OE)

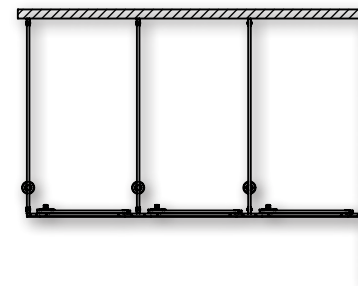

Between Walls (BW)

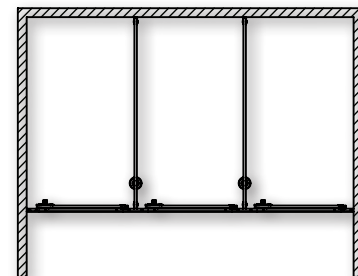

Toilet Cubicle Door Options

Infant Sizes

Wave

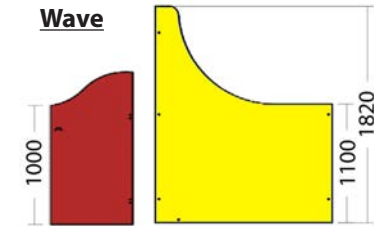

Junior Sizes

Curve

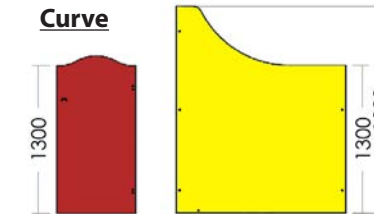

Fittings and Accessories

Rainbows fittings are built to stand the test of time. They are available in three choices;

- Satin anodised aluminium
- Black powder coated aluminium
- Multi coloured powder coated aluminium (Red, Yellow and Blue).

13mm Hinges

TCHIN13PMC / TCHIN19PMC

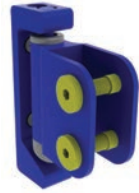

13mm Channel Brackets

TCCHA13PMC / TCCHA19PMC



Coat Hook

TCCHOOKPMC



13mm Round Partition Leg

TCRL13PMC / TCRL19PMC



Rainbow Headrail

TCRRHR

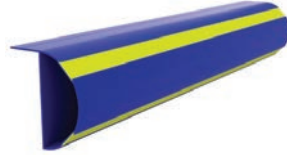

Disabled Rail Handle

TCDRHB



Outward Opening Door Keep

TCODKPMC



Bolt - Yellow Powder Coated

TCTNUTPMC



20mm Blanking Plate

TCRRHRBP20



Internal Lock Catch

TCIDKPMC

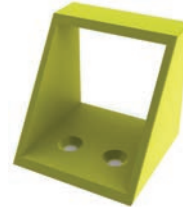

Bolt - Black Powder Coated

TCTNUTPCB



Toilet Roll Holder

TCTRHOLDPMC



Door Lock Pack - Blue

TCLOCKB



30mm Blanking Plate

TCRRHRBP30

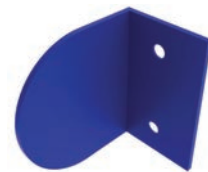

Vanity Units

The Rainbow range of vanity units has an exceptional resistance to water and impact and is available in matching colours to the Rainbow range of cubicles.

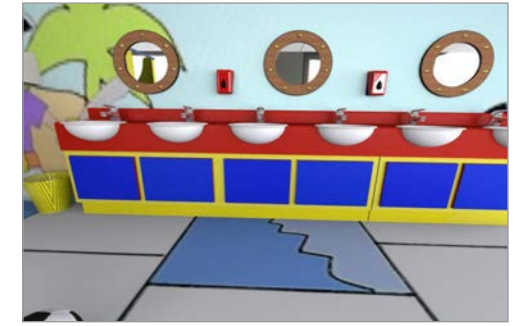
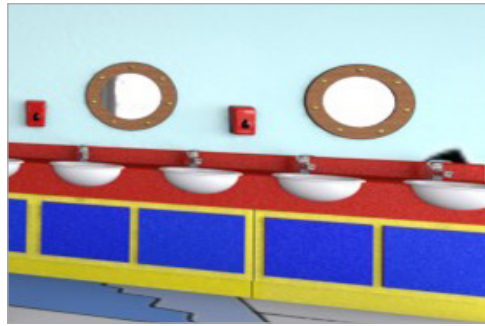

Vanity Unit Layout Options

Standard Vanity Unit

RRVSTD

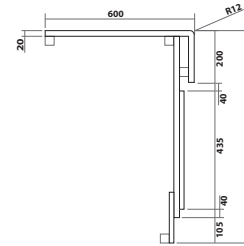

Semi-recessed Vanity Unit

RRVSR

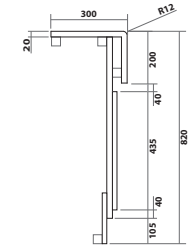

Standard Vanity Unit with Loose Upstand

RRVSTDLU

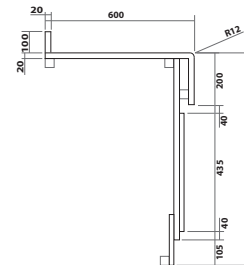

Semi-recessed Vanity Unit with Loose Upstand

RRVSR LU

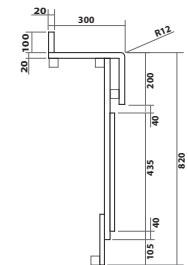

Standard Vanity Unit with Coved Integral Upstand

RRVSTDCU

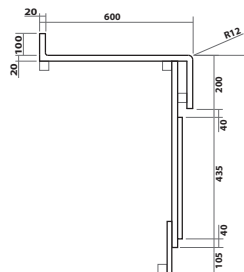

Semi-recessed Vanity Unit with Coved Integral Upstand

RRVSR CU

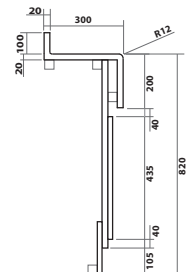

Units 5-7, Luton Street
Liverpool
L5 9XR

T: 0844 800 7785
F: 0844 800 7738
E: sales@totalcubicles.co.uk

IPS Units

The Rainbow range of IPS units has an exceptional resistance to water and impact.



IPS Layout Options

Free Standing (FS)

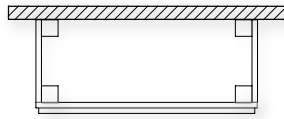

Open Ended Left (OELH)



Open Ended Right (OERH)



Hole In Wall (HIW)



Panel Options

Postformed - available on parallel edges only

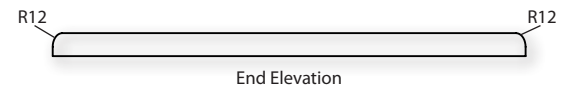

PVC

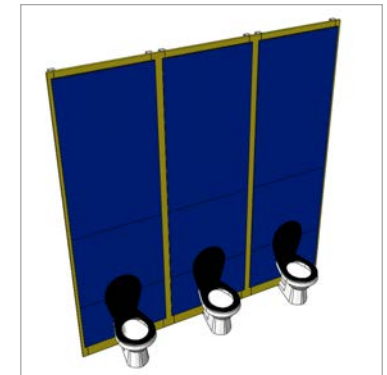
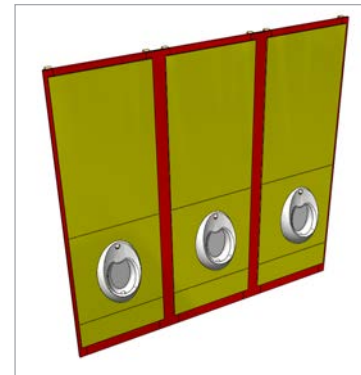
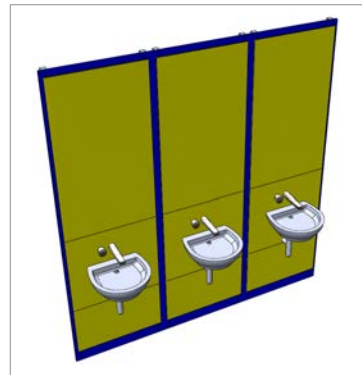
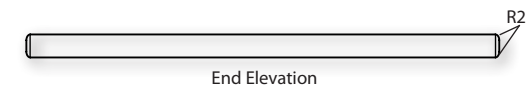

Units 5-7, Luton Street
Liverpool
L5 9XR

T: 0844 800 7785
F: 0844 800 7738
E: sales@totalcubicles.co.uk

Options

Clients wishing to supply their own imagery for the digital print options must ensure that either ai or eps file formats are supplied only (Adobe Illustrator or Photoshop).

Disclaimer

All Text and Strokes Converted to Outlines.

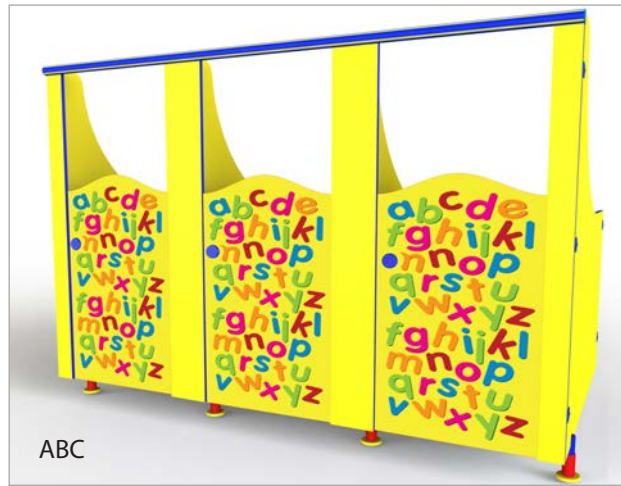

ABC

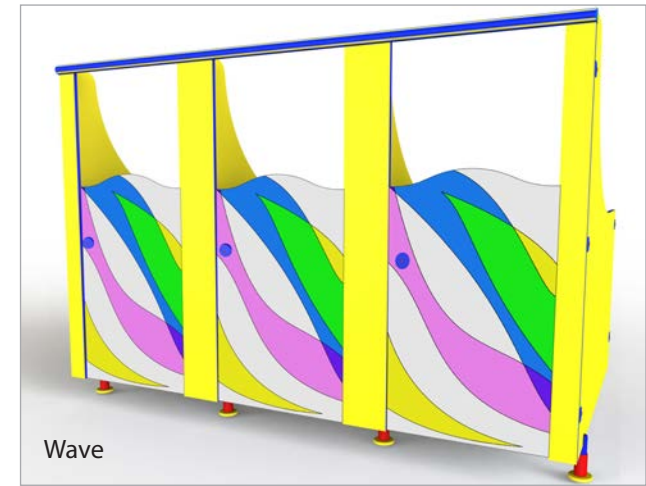

Wave



High Five

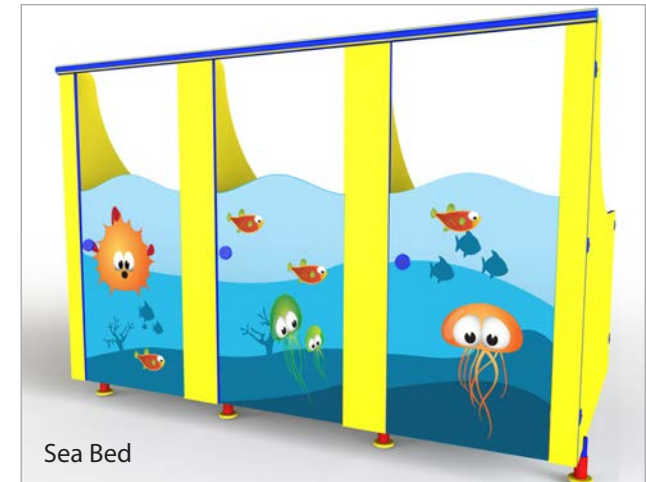

Sea Bed

Mirror Options

Princess Palace & Pink Unicorn



High Five



Deep Space



Lost World

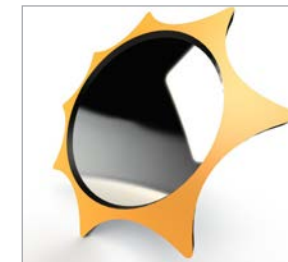

Sea Bed



Units 5-7, Luton Street
Liverpool
L5 9XR

T: 0844 800 7785
F: 0844 800 7738
E: sales@totalcubicles.co.uk

Options

Clients wishing to supply their own imagery for the digital print options must ensure that either ai or eps file formats are supplied only (Adobe Illustrator or Photoshop).

Disclaimer

All Text and Strokes Converted to Outlines.

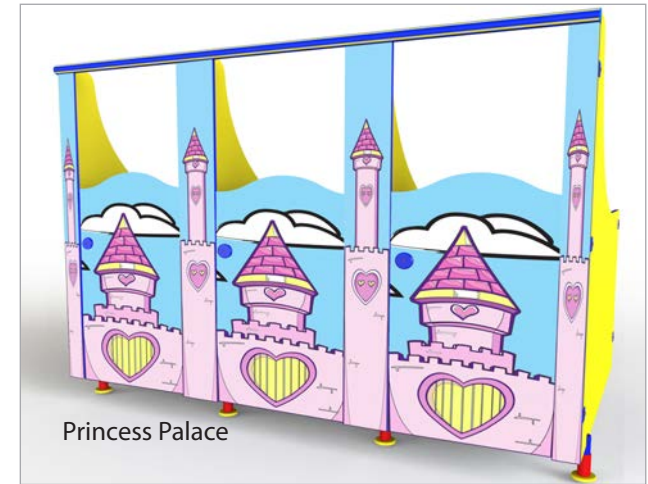

Colour Options

As standard, the Rainbow range has for colour options; Red, Yellow, Green and Blue. However, other colours are available if required. Please contact our sales team if you require more information on the other colours available.



Units 5-7, Luton Street
Liverpool
L5 9XR

T: 0844 800 7785
F: 0844 800 7738

E: sales@totalcubicles.co.uk



Blue
Rainbow Blue



Yellow
Rainbow Yellow



Red
Rainbow Red

Installation Instructions

Please look over the enclosed drawings to familiarise yourself with the parts required to construct your cubicle. Check that the sizes you have provided for manufacture are correct and match the sizes on site.

Installing The Partitions

Please Note: We no longer pre-drill the partitions as Soil Stacks and Window Placements can compromise the fitting position. Normally our Cubicles are divided equally along the wallspace except where Ambulant or Disabled Cubicles are to be implemented.

Step 1

Fix the partition channel brackets to the rear wall using 35x4mm posi screws and red plugs.

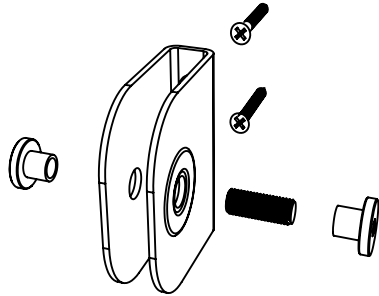

Step 2

The partitions should be set up 135mm off the floor on the adjustable leg provided. Tighten the Allen Head Clamp down securely on the partition

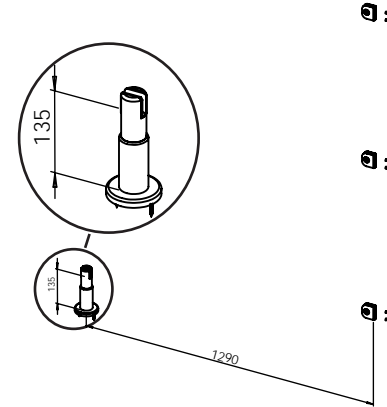

Step 3

Next check the squareness of the partition and then fix the height adjustable leg to the floor with 35x4mm posi screws and red plugs, (please ensure before drilling that no under floor heating is present).

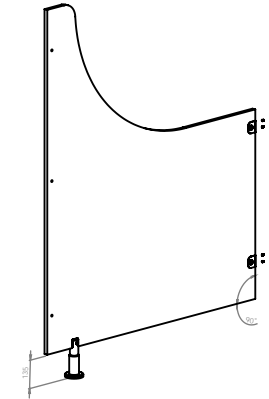

Installing Pilasters

Step 4

Start by installing an end pilasters back to the wall on the brackets provided, using 35x4mm posi screws and red plugs.

Set the pilaster height 135mm up from the floor to match the partition height and tighten the T-Nuts down securely on the pilaster

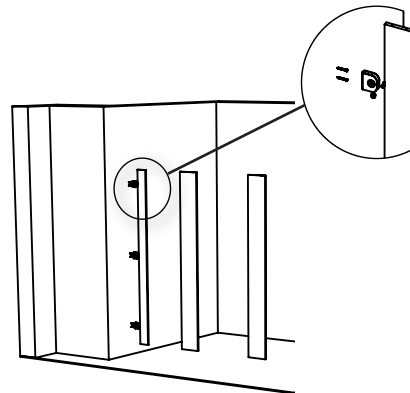

Step 5

Fit the channel brackets centrally to the back of the centre pilaster, pilot the holes 10mm deep and fix with 20x4mm B2P screws.

Fit the pilaster by bolting through with the T-Nuts provided. Tighten securely with an Allen Key.

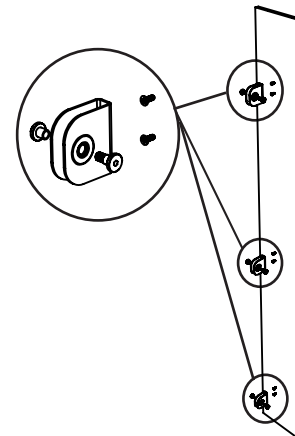

Check Measurements

Step 6

Next, measure the door aperture; it should measure 35mm less than the overall width of the door. If this matches, you can continue on, installing the remaining centre pilasters, again checking the aperture and measurements as you go.

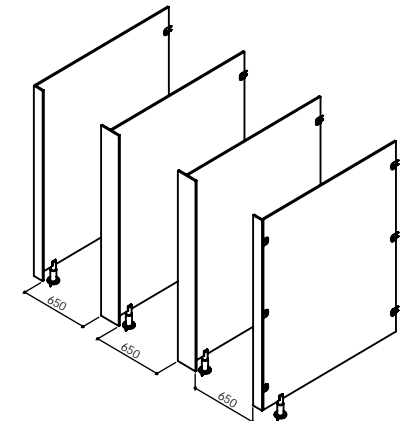

Units 5-7, Luton Street
Liverpool
L5 9XR

T: 0844 800 7785
F: 0844 800 7738
E: sales@totalcubicles.co.uk

Installation Instructions

Please look over the enclosed drawings to familiarise yourself with the parts required to construct your cubicle. Check that the sizes you have provided for manufacture are correct and match the sizes on site.

Fit The Channel Headrail

Step 7

The Channel headrail is what braces the whole cubicle construction, so correct fitment of this item is essential. Start by cutting the headrail to the correct length. Next, fit the rail over the pilasters between the partitions using 35x4mm screws.

Pre-drill the pilasters through the top of the headrail and affix 3 15x4mm screws into the top of each pilaster bracing the construction.

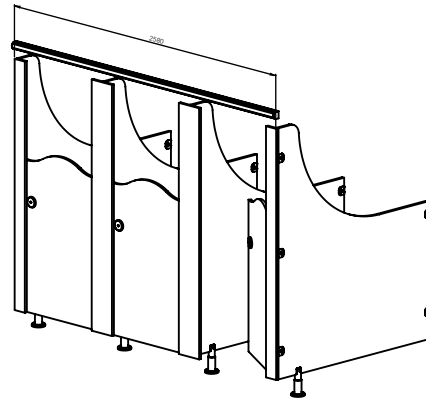

Fitting The Doors And Lock Keeps

Step 8

The doors provided should overlap the aperture by 35mm. The door should now be fitted ensuring an equal overlap of 17.5mm on either side of the pilaster/aperture.

Use the 25x4mm screws piloted to a depth of 20mm to fit the hinges and 25x4 screws piloted to 20mm deep to fit the lock back plate assembly. Next fit the lock keep on the pilaster with 25x4mm screws.

Please Note: The nylon cams in the hinges can be adjusted to allow the door to swing open or closed. To change the operation of the closure, remove the nylon cam and turn in through 90 degrees. The locks are also symmetrical and can be used on either side of the door.

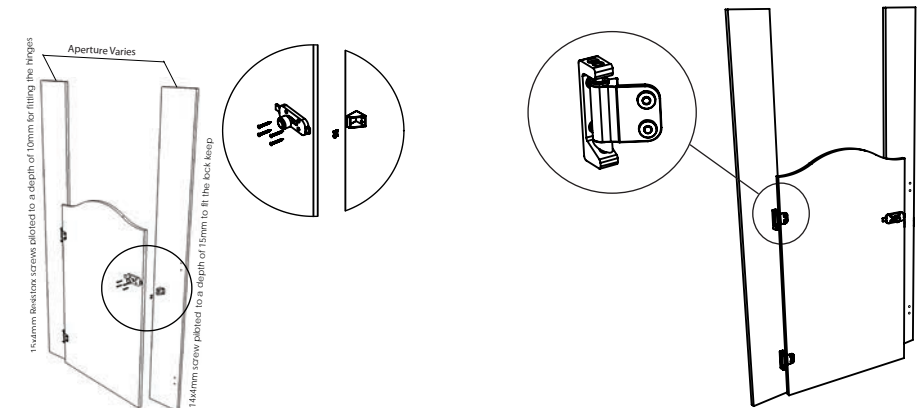

Accessories

Step 9

Fit the hat, coat hook and toilet roll holders at the desired height using the 20x4mm B2P screws piloted to 15mm depth.

Please Note: We can, upon request, provide T-Nuts so the hinges and pillaster are bolted through. This is sometimes a more robust solution when vandalism is prevalent, though standard construction is aesthetically more pleasing to look at than the bolt through option.

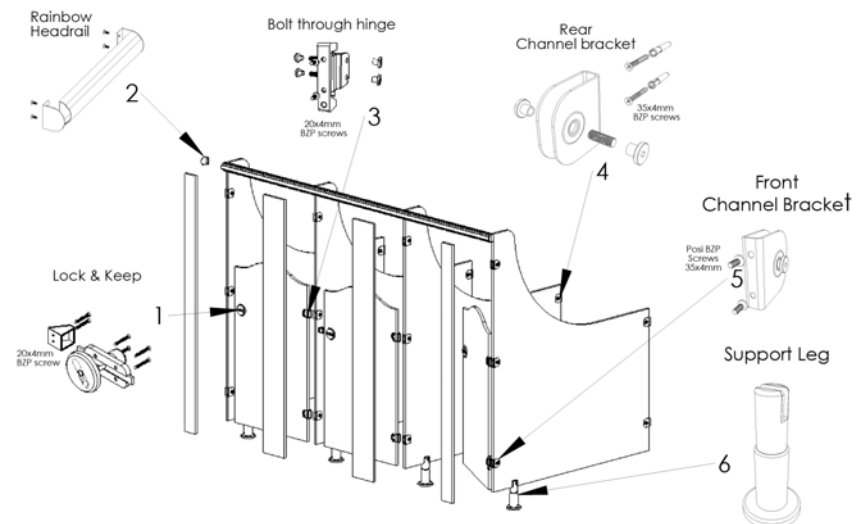

Units 5-7, Luton Street
Liverpool
L5 9XR

T: 0844 800 7785
F: 0844 800 7738
E: sales@totalcubicles.co.uk